



Programmable Controller

MELSEC iQ-F
series

MELSEC iQ-F

FX5 User's Manual



(Positioning Control - Intelligent function module)

SAFETY PRECAUTIONS

(Read these precautions before use.)

Before using this product, please read this manual and the relevant manuals introduced in this manual carefully and pay full attention to safety in order to handle the product correctly.

This manual classifies the safety precautions into two categories: [⚠️ WARNING] and [⚠️ CAUTION].

 WARNING	Indicates that incorrect handling may cause hazardous conditions, resulting in death or severe injury.
 CAUTION	Indicates that incorrect handling may cause hazardous conditions, resulting in minor or moderate injury or property damage.

Depending on the circumstances, procedures indicated by [⚠️ CAUTION] may also cause severe injury.

It is important to follow all precautions for personal safety.

Store this manual in a safe place so that it can be read whenever necessary. Always forward it to the end user.

[DESIGN PRECAUTIONS]

WARNING

- Make sure to set up the following safety circuits outside the PLC to ensure safe system operation even during external power supply problems or PLC failure. Otherwise, malfunctions may cause serious accidents.
 - Most importantly, set up the following: an emergency stop circuit, a protection circuit, an interlock circuit for opposite movements (such as normal vs. reverse rotation), and an interlock circuit (to prevent damage to the equipment at the upper and lower positioning limits).
 - Note that when the CPU module detects an error, such as a watchdog timer error, during self-diagnosis, all outputs are turned off. Also, when an error that cannot be detected by the CPU module occurs in an input/output control block, output control may be disabled. External circuits and mechanisms should be designed to ensure safe machinery operation in such a case.
 - Note that the output current of the 24 V DC service power supply varies depending on the model and the absence/presence of extension modules. If an overload occurs, the voltage automatically drops, inputs in the PLC are disabled, and all outputs are turned off. External circuits and mechanisms should be designed to ensure safe machinery operation in such a case.
 - Note that when an error occurs in a relay, transistor or triac of an output circuit, the output might stay on or off. For output signals that may lead to serious accidents, external circuits and mechanisms should be designed to ensure safe machinery operation in such a case.
- At Forward/Reverse rotation limits, make sure to wire the contacts with NC, negative-logic. Wiring contacts with NO, positive-logic may cause serious accidents.
- In an output circuit, when a load current exceeding the current rating or an overcurrent caused by a load short-circuit flows for a long time, it may cause smoke and fire. To prevent this, configure an external safety circuit, such as a fuse.

[DESIGN PRECAUTIONS]

CAUTION

- Simultaneously turn on and off the power supplies of the CPU module and extension modules.

[INSTALLATION PRECAUTIONS]

WARNING

- Make sure to cut off all phases of the power supply externally before attempting installation or wiring work. Failure to do so may cause electric shock or damage to the product.
 - Use the product within the generic environment specifications described in the User's Manual (Hardware) of the CPU module used.
Never use the product in areas with excessive dust, oily smoke, conductive dusts, corrosive gas (salt air, Cl₂, H₂S, SO₂ or NO₂), flammable gas, vibration or impacts, or expose it to high temperature, condensation, or rain and wind.
If the product is used in such conditions, electric shock, fire, malfunctions, deterioration or damage may occur.
-

[INSTALLATION PRECAUTIONS]

CAUTION

- Do not touch the conductive parts of the product directly. Doing so may cause device failures or malfunctions.
 - When drilling screw holes or wiring, make sure that cutting and wiring debris do not enter the ventilation slits of the PLC. Failure to do so may cause fire, equipment failures or malfunctions.
 - For the product supplied together with a dust proof sheet, the sheet should be affixed to the ventilation slits before the installation and wiring work to prevent foreign objects such as cutting and wiring debris.
However, when the installation work is completed, make sure to remove the sheet to provide adequate ventilation. Failure to do so may cause fire, equipment failures or malfunctions.
 - Install the product on a flat surface. If the mounting surface is rough, undue force will be applied to the PC board, thereby causing nonconformities.
 - Install the product securely using a DIN rail or mounting screws.
 - Work carefully when using a screwdriver such as installation of the product. Failure to do so may cause damage to the product or accidents.
 - Connect the extension cables, peripheral device cables, input/output cables and battery connecting cable securely to their designated connectors. Loose connections may cause malfunctions.
 - Turn off the power to the PLC before attaching or detaching the following devices. Failure to do so may cause equipment failures or malfunctions.
 - Peripheral devices, expansion board, expansion adapter, and connector conversion adapter
 - Extension modules, bus conversion module and connector conversion module
 - Battery
-

[WIRING PRECAUTIONS]

WARNING

- Make sure to cut off all phases of the power supply externally before attempting installation or wiring work. Failure to do so may cause electric shock or damage to the product.
 - Make sure to attach the terminal cover, provided as an accessory, before turning on the power or initiating operation after installation or wiring work. Failure to do so may cause electric shock.
 - The temperature rating of the cable should be 80°C or more.
 - Make sure to wire the screw terminal block in accordance with the following precautions. Failure to do so may cause electric shock, equipment failures, a short-circuit, wire breakage, malfunctions, or damage to the product.
 - The disposal size of the cable end should follow the dimensions described in the User's Manual (Hardware) of the CPU module used.
 - Tightening torque should follow the specifications in the User's Manual (Hardware) of the CPU module used.
 - Tighten the screws using a Phillips-head screwdriver No.2 (shaft diameter 6 mm or less). Make sure that the screwdriver does not touch the partition part of the terminal block.
 - Make sure to properly wire to the terminal block (European type) in accordance with the following precautions. Failure to do so may cause electric shock, equipment failures, a short-circuit, wire breakage, malfunctions, or damage to the product.
 - The disposal size of the cable end should follow the dimensions described in the User's Manual (Hardware) of the CPU module used.
 - Tightening torque should follow the specifications in the User's Manual (Hardware) of the CPU module used.
 - Twist the end of strand wire and make sure that there are no loose wires.
 - Do not solder-plate the electric wire ends.
 - Do not connect more than the specified number of wires or electric wires of unspecified size.
 - Affix the electric wires so that neither the terminal block nor the connected parts are directly stressed.
 - Make sure to properly wire to the spring clamp terminal block in accordance with the following precautions. Failure to do so may cause electric shock, equipment failures, a shortcircuit, wire breakage, malfunctions, or damage to the product.
 - The disposal size of the cable end should follow the dimensions described in the manual.
 - Twist the ends of stranded wires and make sure that there are no loose wires.
 - Do not solder-plate the electric wire ends.
 - Do not connect more than the specified number of wires or electric wires of unspecified size.
 - Affix the electric wires so that neither the terminal block nor the connected parts are directly stressed.
-

[WIRING PRECAUTIONS]

CAUTION

- Perform class D grounding (grounding resistance: 100 Ω or less) of the grounding terminal on the CPU module with a wire 2 mm² or thicker. Do not use common grounding with heavy electrical systems (refer to the User's Manual (Hardware) of the CPU module used).
 - Connect the power supply wiring to the dedicated terminals described in this manual. If an AC power supply is connected to a DC input/output terminal or DC power supply terminal, the PLC will burn out.
 - Do not wire vacant terminals externally. Doing so may damage the product.
 - Install module so that excessive force will not be applied to terminal blocks, power connectors or I/O connectors. Failure to do so may result in wire damage/breakage or PLC failure.
 - Make sure to observe the following precautions in order to prevent any damage to the machinery or accidents due to malfunction of the PLC caused by abnormal data written to the PLC due to the effects of noise.
 - Do not bundle the power line and I/O cables together with or lay them close to the main circuit, high-voltage line, load line or power line. As a guideline, lay the power line and I/O cables at least 100 mm away from the main circuit, high-voltage line, load line or power line.
-

[STARTUP AND MAINTENANCE PRECAUTIONS]

WARNING

- Do not touch any terminal while the PLC's power is on. Doing so may cause electric shock or malfunctions.
 - Before cleaning or retightening terminals, cut off all phases of the power supply externally. Failure to do so in the power ON status may cause electric shock.
 - Before modifying the program in operation, forcible output, running or stopping the PLC, read through this manual carefully, and ensure complete safety. An operation error may damage the machinery or cause accidents.
-

[STARTUP AND MAINTENANCE PRECAUTIONS]

CAUTION

- Do not disassemble or modify the PLC. Doing so may cause fire, equipment failures, or malfunctions. For repair, contact your local Mitsubishi Electric representative.
 - Turn off the power to the PLC before connecting or disconnecting any extension cable. Failure to do so may cause equipment failures or malfunctions.
 - Turn off the power to the PLC before attaching or detaching the following devices. Failure to do so may cause equipment failures or malfunctions.
 - Peripheral devices, expansion board, expansion adapter, and connector conversion adapter
 - Extension modules, bus conversion module and connector conversion module
 - Battery
-

[OPERATION PRECAUTIONS]

CAUTION

- Construct an interlock circuit in the program so that the whole system always operates on the safe side before executing the control (for data change) of the PLC in operation. Read the manual thoroughly and ensure complete safety before executing other controls (for program change, parameter change, forcible output and operation status change) of the PLC in operation. Otherwise, the machine may be damaged and accidents may occur by erroneous operations.
 - Note that the whole system may not be reset by the RUN/STOP/RESET switch when the CPU module or intelligent function module detects an error, such as a watchdog timer error, during self-diagnosis. In such cases, turn the power off and on again.
-

[DISPOSAL PRECAUTIONS]

CAUTION

- Please contact a certified electronic waste disposal company for the environmentally safe recycling and disposal of your device.
-

[TRANSPORTATION PRECAUTIONS]

CAUTION

- The PLC is a precision instrument. During transportation, avoid impacts larger than those specified in the general specifications of the User's Manual (Hardware) of the CPU module by using dedicated packaging boxes and shock-absorbing palettes. Failure to do so may cause failures in the PLC. After transportation, verify operation of the PLC and check for damage of the mounting part, etc.
-

INTRODUCTION

This manual contains text, diagrams and explanations which will guide the reader in the correct installation, safe use and operation of the positioning module of MELSEC iQ-F series and should be read and understood before attempting to install or use the module.

Always forward it to the end user.

Regarding use of this product

- This product has been manufactured as a general-purpose part for general industries, and has not been designed or manufactured to be incorporated in a device or system used in purposes related to human life.
- Before using the product for special purposes such as nuclear power, electric power, aerospace, medicine or passenger movement vehicles, consult Mitsubishi Electric.
- This product has been manufactured under strict quality control. However when installing the product where major accidents or losses could occur if the product fails, install appropriate backup or failsafe functions in the system.

Note

- If in doubt at any stage during the installation of the product, always consult a professional electrical engineer who is qualified and trained in the local and national standards. If in doubt about the operation or use, please consult the nearest Mitsubishi Electric representative.
- Since the examples indicated by this manual, technical bulletin, catalog, etc. are used as a reference, please use it after confirming the function and safety of the equipment and system. Mitsubishi Electric will accept no responsibility for actual use of the product based on these illustrative examples.
- This manual content, specification etc. may be changed without a notice for improvement.
- The information in this manual has been carefully checked and is believed to be accurate; however, if you notice a doubtful point, an error, etc., please contact the nearest Mitsubishi Electric representative. When doing so, please provide the manual number given at the end of this manual.

MEMO

CONTENTS

SAFETY PRECAUTIONS	1
INTRODUCTION	6
RELEVANT MANUALS	14
TERMS	15
CHAPTER 1 DESCRIPTION	17
CHAPTER 2 SPECIFICATIONS	19
2.1 General Specifications	19
2.2 Power Supply Specifications	19
2.3 Performance Specifications	19
2.4 External Device Output Interface Specifications	21
I/O signals electrical specifications	21
2.5 Part Names	25
LED display specifications	26
CHAPTER 3 PROCEDURES BEFORE OPERATIONS	27
CHAPTER 4 FUNCTIONS LIST	29
4.1 Control Functions	29
4.2 Positioning Functions	30
4.3 Main Functions	30
4.4 Sub Function, Common Function	32
4.5 Combining Main and Sub Functions	34
4.6 Combining Various Sub Functions	39
CHAPTER 5 SYSTEM CONFIGURATION	47
CHAPTER 6 WIRING	49
6.1 Power Supply Wiring	49
Grounding	49
6.2 Differential Driver Common Terminal	50
6.3 Connector Wiring	52
Usable connectors	52
Connector wiring methods	52
Connecting the connectors	54
Wiring example when using shielded cables	55
Precautions	56
6.4 Connector for Connecting External Devices	56
Connector signal array for connecting external devices	56
List of I/O signal detail	57
Internal I/O interface circuits	59
CHAPTER 7 STARTING AND STOPPING	62
7.1 Starting	62
Normal start	65
Quick start	66
Multiple axes simultaneous start	71

7.2	Stopping	73
7.3	Restarting	77
CHAPTER 8 OPR CONTROL		79
8.1	Overview of the OPR Control	79
	Two types of OPR controls	79
8.2	Machine OPR	80
	Operation overview of the machine OPR	80
	Machine OPR method	81
	Near-point dog method	83
	Stopper method 1	85
	Stopper method 2	88
	Stopper method 3	91
	Count method 1	93
	Count method 2	95
	Data setting method	97
	Limit switch combined-use method	98
8.3	Fast OPR	100
	Operation overview of the fast OPR	100
CHAPTER 9 MAJOR POSITIONING CONTROL		102
9.1	Overview of the Major Positioning Controls	102
	Data required for major positioning control	103
	Operation pattern of major positioning control	104
	Specifying the positioning address	111
	Checking the current value	112
	Handling degree (control unit)	114
	Interpolation control	117
9.2	Positioning Data Settings	121
	Relation between each control and positioning data	121
	1-axis linear control	123
	2-axis linear interpolation control	125
	Fixed-feed control	129
	2-axis circular interpolation control with the sub point specified	131
	2-axis circular interpolation control with the center point specified	135
	Speed control	141
	Speed-position switching control (INC mode)	144
	Speed-position switching control (ABS mode)	152
	Position-speed switching control	158
	Current value change	165
	NOP instruction	169
	JUMP instruction	170
	LOOP	172
	LEND	173
CHAPTER 10 ADVANCED POSITIONING CONTROL		174
10.1	Overview of Advanced Positioning Control	174
	Data required for advanced positioning control	175
	Block start data and Condition data configurations	176
10.2	Implementation Procedure for Advanced Positioning Control	177

10.3	Setting the Block Start Data	178
	Relation between various controls and block start data	178
	Block start (normal start)	179
	Condition start	181
	Wait start	182
	Simultaneous start	183
	Repeated start (FOR loop)	184
	Repeated start (FOR condition)	185
	Restrictions when the NEXT start is used	186
10.4	Setting the Condition Data	187
	Relation between various controls and condition data	187
	Setting examples of the condition data	189
10.5	Start Program for the Advanced Positioning Control	190
	Starting the advanced positioning control	190
	Start program example for the advanced positioning control	191

CHAPTER 11 MANUAL CONTROL **194**

11.1	Overview of the Manual Control	194
	Three manual control methods	194
11.2	JOG Operation	196
	Overview of the JOG operation	196
	Operation procedure of the JOG operation	198
	Parameters required for the JOG operation	199
	Creating a start program for the JOG operation	200
	Operation example of the JOG operation	202
11.3	Inching Operation	204
	Operation overview of the inching operation	204
	Operation procedure of the inching operation	206
	Parameters required for the inching operation	207
	Creating a start program for the inching operation	208
	Operation example of the inching operation	210
11.4	Manual Pulse Generator Operation	211
	Operation overview of the manual pulse generator operation	211
	Operation procedure of the manual pulse generator operation	214
	Parameters required for the manual pulse generator operation	215
	Creating a program to enable or disable the manual pulse generator operation	216

CHAPTER 12 CONTROL SUB FUNCTION **218**

12.1	Overview of Sub Functions	218
	Overview of Sub Functions	218
12.2	Sub Functions Specific to Machine OPR	220
	OPR retry function	220
	OP shift function	224
12.3	Function to Compensate Control	227
	Backlash compensation function	227
	Electronic gear function	228
	Near pass function	233
	Output timing selection of near pass control	235
12.4	Function to Limit Control	237
	Speed limit function	237

Torque limit function	239
Software stroke limit function	242
Hardware stroke limit function	248
12.5 Functions that Change Control Details	250
Speed change function	250
Override function	255
Acceleration/deceleration time change function	258
Torque change function	261
Target position change function	263
12.6 Function Related to Start	266
Pre-reading start function	266
Start time adjustment function	269
12.7 Absolute Position Restoration Function	271
Configuration and preparation of the absolute position detection system	271
Overview of the absolute position detection system	272
Transmission procedure for absolute position signal	272
Control precautions	274
Restrictions on movement amounts	274
12.8 Function Related to Stop	276
Stop command processing for deceleration stop function	276
Continuous operation interrupt function	278
Step function	280
12.9 Other Functions	284
Skip function	284
M code output function	287
Teaching function	291
Command in-position function	296
Acceleration/deceleration processing function	298
Deceleration start flag function	300
During uncompleted OPR operation setting function	302
Interrupt function	303
CHAPTER 13 COMMON FUNCTIONS	309
13.1 Overview of Common Functions	309
13.2 Module Data Initialization Function	310
13.3 Module Data Backup Function	312
13.4 External I/O Signal Logic Switching Function	314
13.5 External I/O Signal Monitor Function	315
13.6 History Monitor Function	316
13.7 Event History Function	317
13.8 Amplifier-less Operation Function	319
CHAPTER 14 PARAMETER SETTING	323
14.1 Parameter Setting Procedure	323
14.2 Module Parameters	324
Basic setting	324
Application setting	328
Interrupt setting	329
Refresh settings	330

14.3	Module Extension Parameter	332
	Positioning data	332
	Block start data	337
CHAPTER 15 MONITORING/TEST		339
15.1	Positioning Monitor	339
15.2	Positioning Test	340
CHAPTER 16 SPECIFICATIONS OF I/O SIGNALS WITH CPU MODULE		350
16.1	List of I/O Signals with CPU Module	350
16.2	Details of Input Signals	351
16.3	Details of Output Signals	352
16.4	I/O Signals Allocation of Module Diagnostic	353
CHAPTER 17 DATA USED FOR POSITIONING CONTROL		354
17.1	Types of Data	354
	Parameters and data required for the control	354
	Setting items for positioning parameters	356
	Setting items for OPR parameters	361
	Setting items for positioning data	362
	Block start data setting items	364
	Setting items for condition data	364
17.2	List of Buffer Memory Addresses	365
17.3	Basic Setting	385
	Basic parameter 1	385
	Basic parameter 2	394
	Detailed parameter 1	396
	Detailed parameter 2	404
	OPR basic parameter	413
	OPR detailed parameter	417
17.4	Positioning Data	423
17.5	Block Start Data	434
17.6	Condition Data	438
17.7	Monitor Data	442
	System monitor data	442
	Axis monitor data	454
17.8	Control Data	466
	System control data	466
	Axis control data	470
17.9	Interrupt Setting	484
17.10	Basic Parameter 3	486
17.11	Parameter Reflection	487
CHAPTER 18 PROGRAMMING		491
18.1	Precautions on Programming	491
18.2	Creating Programs	492
	Overall configuration of programs	492
18.3	Example Positioning Program Using Labels	493
	List of Labels Used	493
	Program example	496

CHAPTER 19 TROUBLESHOOTING	512
19.1 Troubleshooting Procedure	512
Checks with LEDs	512
Check of module status	513
19.2 Troubleshooting by Symptom	514
19.3 Error and Warning Details	516
Error type	516
Error code classification	517
Error storage	517
Warning type	518
Warning classification	518
Warning storage	518
Clearing errors or warnings	519
19.4 List of Warning Codes	520
19.5 List of Error Codes	524
APPENDIX	546
Appendix 1 Dimensions Diagram	546
Appendix 2 Standards	547
Certification of UL, cUL standards	547
Compliance with EC directive (CE Marking)	547
Requirement for compliance with EMC directive	547
Caution for compliance with EC Directive	548
Appendix 3 Module Label	549
Appendix 4 Dedicated Instruction	551
Appendix 5 How to Find Buffer Memory Addresses	552
Appendix 6 External Connection Diagram	557
Mitsubishi Electric servo amplifier connection example	557
Appendix 7 Configuration Device List	559
Appendix 8 Precautions for Using a Stepping Motor	560
Appendix 9 Added and Enhanced Functions	561
INDEX	562
REVISIONS	566
WARRANTY	567
TRADEMARKS	568

RELEVANT MANUALS

Manual name <manual number>	Description
MELSEC iQ-F FX5 User's Manual (Startup) <JY997D58201>	Performance specifications, procedures before operation, and troubleshooting of the CPU module.
MELSEC iQ-F FX5UJ User's Manual (Hardware) <SH-082206ENG>	Describes the details of hardware of the FX5UJ CPU module, including input/output specifications, wiring, installation, and maintenance.
MELSEC iQ-F FX5U User's Manual (Hardware) <JY997D55301>	Describes the details of hardware of the FX5U CPU module, including input/output specifications, wiring, installation, and maintenance.
MELSEC iQ-F FX5UC User's Manual (Hardware) <JY997D61401>	Describes the details of hardware of the FX5UC CPU module, including input/output specifications, wiring, installation, and maintenance.
MELSEC iQ-F FX5 User's Manual (Application) <JY997D55401>	Describes basic knowledge required for program design, functions of the CPU module, devices/labels, and parameters.
MELSEC iQ-F FX5 Programming Manual (Program Design) <JY997D55701>	Describes specifications of ladders, ST, FBD/LD, and other programs and labels.
MELSEC iQ-F FX5 Programming Manual (Instructions, Standard Functions/Function Blocks) <JY997D55801>	Describes specifications of instructions and functions that can be used in programs.
MELSEC iQ-F FX5 User's Manual (Serial Communication) <JY997D55901>	Describes N:N network, Parallel link, MELSEC Communication protocol, inverter communication, non-protocol communication, and predefined protocol support.
MELSEC iQ-F FX5 User's Manual (MELSEC Communication Protocol) <JY997D60801>	Explains methods for the device that is communicating with the CPU module by MC protocol to read and write the data of the CPU module.
MELSEC iQ-F FX5 User's Manual (MODBUS Communication) <JY997D56101>	Describes MODBUS serial communication and MODBUS/TCP communication.
MELSEC iQ-F FX5 User's Manual (PROFIBUS) <SH-081910ENG>	Describes the functions of the PROFIBUS-DP master module.
MELSEC iQ-F FX5 User's Manual (Ethernet Communication) <JY997D56201>	Describes the Ethernet communication function of the CPU module built-in and the Ethernet module.
MELSEC iQ-F FX5-ENET User's Manual <SH-082026ENG>	Describes the functions of the Ethernet module.
MELSEC iQ-F FX5-ENET/IP User's Manual <SH-082027ENG>	Describes the functions of the FX5-ENET/IP.
MELSEC iQ-F FX5 User's Manual (SLMP) <JY997D56001>	Explains methods for the device that is communicating with the CPU module by SLMP to read and write the data of the CPU module.
MELSEC iQ-F FX5 User's Manual (CC-Link IE) <JY997D64201>	Describes CC-Link IE field network module.
MELSEC iQ-F FX5 User's Manual (CC-Link) <SH-081793ENG>	Describes CC-Link system master/intelligent device module.
MELSEC iQ-F FX5 User's Manual (AnyWireASLINK) <SH-081796ENG>	Describes AnyWireASLINK system master module.
MELSEC iQ-F FX5 User's Manual (Positioning Control - CPU module built-in, High-speed pulse input/output module) <JY997D56301>	Describes the positioning function of the CPU module built-in and the high-speed pulse input/output module.
MELSEC iQ-F FX5 User's Manual (Positioning Control - Intelligent function module) <SH-081805ENG> (This manual)	Describes the positioning module.
MELSEC iQ-F FX5 Simple Motion Module User's Manual (Startup) <IB0300251>	Specifications, procedures before operation, system configuration, wiring, and operation examples of the Simple Motion module.
MELSEC iQ-F FX5 Simple Motion Module User's Manual (Application) <IB0300253>	Functions, input/output signals, buffer memories, parameter settings, programming, and troubleshooting of the Simple Motion module.
MELSEC iQ-F FX5 Simple Motion Module User's Manual (Advanced Synchronous Control) <IB0300255>	Functions and programming for the synchronous control of the Simple Motion module.
MELSEC iQ-F FX5 User's Manual (Analog Control - CPU module built-in, Expansion adapter) <JY997D60501>	Describes the analog function of the CPU module built-in and the analog adapter.
MELSEC iQ-F FX5 User's Manual (Analog Control - Intelligent function module) <SH-081802ENG>	Describes the analog input module, analog output module, and multiple input module.
MELSEC iQ-F FX5 User's Manual (Temperature Control) <SH-081799ENG>	Describes the temperature control module.

Manual name <manual number>	Description
MELSEC iQ-F FX5 User's Manual (Safety Control) <SH-082078ENG>	Describes the safety extension modules.
GX Works3 Operating Manual <SH-081215ENG>	System configuration, parameter settings, and online operations of GX Works3.
Transition from MELSEC FX3G, FX3U, FX3UC Series to MELSEC iQ-F Series Handbook <JY997D66201>	Describes the transition from MELSEC FX3G/FX3U/FX3UC series to MELSEC iQ-F series.

TERMS

Unless otherwise specified, this manual uses the following terms.

For details on the FX3 devices that can be connected with the FX5, refer to the User's Manual (Hardware) of the CPU module to be used.

Terms	Description
■Devices	
FX5	Generic term for FX5UJ, FX5U and FX5UC PLCs
FX3	Generic term for FX3S, FX3G, FX3GC, FX3U, and FX3UC PLCs
FX5 CPU module	Generic term for FX5UJ CPU module, FX5U CPU module and FX5UC CPU module
FX5UJ CPU module	Generic term for FX5UJ-24MR/ES, FX5UJ-24MT/ES, FX5UJ-24MT/ESS, FX5UJ-40MR/ES, FX5UJ-40MT/ES, FX5UJ-40MT/ESS, FX5UJ-60MR/ES, FX5UJ-60MT/ES, and FX5UJ-60MT/ESS
FX5U CPU module	Generic term for FX5U-32MR/ES, FX5U-32MT/ES, FX5U-32MT/ESS, FX5U-64MR/ES, FX5U-64MT/ES, FX5U-64MT/ESS, FX5U-80MR/ES, FX5U-80MT/ES, FX5U-80MT/ESS, FX5U-32MR/DS, FX5U-32MT/DS, FX5U-32MT/DSS, FX5U-64MR/DS, FX5U-64MT/DS, FX5U-64MT/DSS, FX5U-80MR/DS, FX5U-80MT/DS, and FX5U-80MT/DSS
FX5UC CPU module	Generic term for FX5UC-32MT/D, FX5UC-32MT/DSS, FX5UC-64MT/D, FX5UC-64MT/DSS, FX5UC-96MT/D, FX5UC-96MT/DSS, FX5UC-32MT/DS-TS, FX5UC-32MT/DSS-TS, and FX5UC-32MR/DS-TS
Extension module	Generic term for FX5 extension modules, FX3 function modules, Extension modules (extension cable type) and Extension module (extension connector type)
FX5 extension module	Generic term for I/O modules, FX5 extension power supply modules, FX5 intelligent function modules, and FX5 safety extension modules
FX3 extension module	Generic term for FX3 extension power supply module and FX3 intelligent function module
Extension module (extension cable type)	Generic term for Input modules (extension cable type), Output modules (extension cable type), Input/output modules (extension cable type), Powered input/output module, High-speed pulse input/output module, Extension power supply module (extension cable type), Connector conversion module (extension cable type), Intelligent function modules, Safety extension modules, and Bus conversion module (extension cable type)
Extension module (extension connector type)	Generic term for Input modules (extension connector type), Output modules (extension connector type), Input/output modules (extension connector type), Extension power supply module (extension connector type), Connector conversion module (extension connector type), and Bus conversion module (extension connector type)
I/O module	Generic term for Input modules, Output modules, Input/output modules, Powered input/output modules, and High-speed pulse input/output modules
Input module	Generic term for Input modules (extension cable type) and Input modules (extension connector type)
Input module (extension cable type)	Generic term for FX5-8EX/ES and FX5-16EX/ES
Input module (extension connector type)	Generic term for FX5-C16EX/D, FX5-C16EX/DS, FX5-C32EX/D, FX5-C32EX/DS, and FX5-C32EX/DS-TS
Output module	Generic term for Output modules (extension cable type) and Output modules (extension connector type)
Output module (extension cable type)	Generic term for FX5-8EYR/ES, FX5-8EYT/ES, FX5-8EYT/ESS, FX5-16EYR/ES, FX5-16EYT/ES, and FX5-16EYT/ESS
Output module (extension connector type)	Generic term for FX5-C16EYT/D, FX5-C16EYT/DSS, FX5-C16EYR/D-TS, FX5-C32EYT/D, FX5-C32EYT/DSS, FX5-C32EYT/D-TS, and FX5-C32EYT/DSS-TS
Input/output module	Generic term for Input/output modules (extension cable type) and Input/output modules (extension connector type)
Input/output module (extension cable type)	Generic term for FX5-16ER/ES, FX5-16ET/ES, and FX5-16ET/ESS
Input/output module (extension connector type)	Generic term for FX5-C32ET/D, FX5-C32ET/DSS, FX5-C32ET/DS-TS, and FX5-C32ET/DSS-TS
Powered input/output module	Generic term for FX5-32ER/ES, FX5-32ET/ES, FX5-32ET/ESS, FX5-32ER/DS, FX5-32ET/DS, and FX5-32ET/DSS
High-speed pulse input/output module	Generic term for FX5-16ET/ES-H and FX5-16ET/ESS-H
Extension power supply module	Generic term for FX5 extension power supply module and FX3 extension power supply module

Terms	Description
FX5 extension power supply module	Generic term for FX5 extension power supply module (extension cable type) and FX5 extension power supply module (extension connector type)
FX5 extension power supply module (extension cable type)	Different name for FX5-1PSU-5V
FX5 extension power supply module (extension connector type)	Different name for FX5-C1PS-5V
FX3 extension power supply module	Different name for FX3U-1PSU-5V
Intelligent module	The abbreviation for intelligent function modules
Intelligent function module	Generic term for FX5 intelligent function modules and FX3 intelligent function modules
FX5 intelligent function module	Generic term for FX5-4AD, FX5-4DA, FX5-8AD, FX5-4LC, FX5-20PG-P, FX5-20PG-D, FX5-40SSC-S, FX5-80SSC-S, FX5-ENET, FX5-ENET/IP, FX5-CCLIEF, FX5-CCL-MS, FX5-ASL-M, and FX5-DP-M
FX3 intelligent function module	Generic term for FX3U-4AD, FX3U-4DA, FX3U-4LC, FX3U-1PG, FX3U-2HC, FX3U-16CCL-M, FX3U-64CCL, FX3U-128ASL-M, and FX3U-32DP
FX5 safety extension module	Generic term for safety main modules and safety expansion modules
Safety main module	Different name for FX5-SF-MU4T5
Safety expansion module	Generic term for expansion modules installed to a safety main module
Safety input expansion module	Different name for FX5-SF-8DI4
Expansion board	Generic term for board for FX5UJ CPU module and FX5U CPU module
Communication board	Generic term for FX5-232-BD, FX5-485-BD, and FX5-422-BD-GOT
Expansion adapter	Generic term for adapter for FX5 CPU module
Communication adapter	Generic term for FX5-232ADP and FX5-485ADP
Analog adapter	Generic term for FX5-4AD-ADP, FX5-4DA-ADP, FX5-4AD-PT-ADP, and FX5-4AD-TC-ADP
Bus conversion module	Generic term for Bus conversion module (extension cable type) and Bus conversion module (extension connector type)
Bus conversion module (extension cable type)	Different name for FX5-CNV-BUS
Bus conversion module (extension connector type)	Different name for FX5-CNV-BUSC
Connector conversion module	Generic term for Connector conversion module (extension cable type) and Connector conversion module (extension connector type)
Connector conversion module (extension cable type)	Different name for FX5-CNV-IF
Connector conversion module (extension connector type)	Different name for FX5-CNV-IFC
Extended extension cable	Generic term for FX5-30EC and FX5-65EC
Connector conversion adapter	Different name for FX5-CNV-BC
Battery	Different name for FX3U-32BL
SD memory card	Generic term for NZ1MEM-2GBSD, NZ1MEM-4GBSD, NZ1MEM-8GBSD, NZ1MEM-16GBSD, L1MEM-2GBSD and L1MEM-4GBSD SD memory cards Abbreviation of Secure Digital Memory Card. Device that stores data using flash memory.
Peripheral device	Generic term for engineering tools and GOTs
GOT	Generic term for Mitsubishi Electric Graphic Operation Terminal GOT1000 and GOT2000 series
■Software packages	
Engineering tool	The product name of the software package for the MELSEC programmable controllers
GX Works3	The product name of the software package, SWnDND-GXW3, for the MELSEC programmable controllers (The 'n' represents a version.)
■Positioning-related	
Positioning module	Generic term for FX5-20PG-P and FX5-20PG-D
Global label	A label that is valid for all the program data when multiple program data are created in the project. The global label has two types: a module specific label (module label), which is generated automatically by GX Works3, and an optional label, which can be created for any specified device.
Quick start mode	A mode where the module operates with the start time of 0.3 ms. Unless otherwise specified, the functions described in this manual are for when quick start mode is set.
Drive unit (servo amplifier)	A unit that amplifies pulses that are output from the positioning module to control a motor. The unit is provided with a servomotor or stepping motor. It is also called a servo amplifier.
Module label	A text string that represents a buffer memory area specific to each module. For the module used, GX Works3 automatically generates this label, which can be used as a global label.

1 DESCRIPTION

The positioning module is an intelligent function module for high speed, high precision positioning with servo motors or stepping motors via drive units.

Positioning control is easy

The positioning module controls the position and speed using the positioning data set using GX Works3. 600 positioning data max. can be set per axis.

Multiple positioning start methods

The positioning module has normal start in addition to high-speed start and multiple axes simultaneous start. Positioning controls can be started quickly by analyzing in advance the data executed immediately after the current operation to prevent the analysis time affecting the start. Multiple axes simultaneous start can start the axis to be started and its partner axis simultaneously using the same timing. Further, block start that operates sequentially according to multiple positioning start data groups is also possible.

Abundant positioning control functions

The positioning module includes positioning control functions such as OPR control, positioning control, and manual control, etc., and can also use sub functions such as limits and additional functions in counterpoints to these controls.

■OPR control

Near point dog, stopper, count, data set, and Limit switch combined-use are available as OPR control methods for "Machine OPR".

■Major positioning control

The major positioning control methods are position control, speed control, position-speed switching control, and position-speed switching control, etc. Position and speed controls, etc., can be set for each axis using the timing chosen by the operator, and can also implement interpolation control using multiple axes.

■Advanced positioning control

Multiple positioning data can be positioned continuously using a single positioning start. Further, multiple positioning data can comprise one block, and continuous multiple block positioning is also possible.

■Manual control

Manual operations are classified as JOG operations, inching operations, and manual pulse generator operations.

■Sub function

Sub functions compensate or limit the control, or add functions to the control during positioning. More appropriate and highly accurate control can be performed by using these sub functions.

Programming is easy

Using positioning module special commands such as absolute OPR commands, positioning start commands, and teaching commands, etc., enables programs to be simplified. Further, using a function block (FB) enables reduced programming/debugging man hours and improved program readability.

High maintainability

The positioning module can be maintained easily as described below.

- By the external I/O signal monitor function which enables the error information and module information for the positioning module to be monitored, the external I/O status can be checked.
- The history monitor functions, which enable the start history, error history, and warnings history to be monitored during positioning operations, enables the positioning module operations status to be checked.
- By the event history function, the information of error occurred in the positioning module can be stored.
- Checking the parameters and monitoring the control status using GX Works3 for monitoring and testing makes debugging more efficient.

2 SPECIFICATIONS

This chapter describes the positioning module specifications.

2.1 General Specifications

General specifications other than those described below are the same as for the connected CPU module.

See the following manuals for the general specifications.

📖 MELSEC iQ-F FX5UJ User's Manual (Hardware)

📖 MELSEC iQ-F FX5U User's Manual (Hardware)

📖 MELSEC iQ-F FX5UC User's Manual (Hardware)

Items	Specifications	
Dielectric withstand voltage	500 V AC for 1 minute	Between all terminals and ground terminal
Insulation resistance	10 MΩ or higher by 500 V DC insulation resistance tester	

2.2 Power Supply Specifications

Describes the power source specifications.

Items		Specifications	
		FX5-20PG-P	FX5-20PG-D
External power supply	Power source voltage	24 V DC +20%, -15%	
	Allowable instantaneous power failure time	Operation continues when the instantaneous power failure is shorter than 5 ms.	
	Current consumption	120 mA	165 mA

2.3 Performance Specifications

Describes the performance specifications.

Items	Specifications	
	FX5-20PG-P	FX5-20PG-D
Number of control axes	2 axes	
Pulse output form	Transistor	Differential driver
Interpolation function	2-axis linear interpolation, 2-axis circular interpolation	
Control method	PTP (Point-To-Point) control, path control (line and arc can be set), speed control, speed-position switching control, position-speed switching control	
Control unit	mm, inch, degree, pulse	
Positioning data	600 data/axis	
Module Data Backup Function	Save the positioning data and block start data using (battery-free) flash ROM	

Items		Specifications	
		FX5-20PG-P	FX5-20PG-D
Positioning	Positioning system	PTP control: Incremental system/absolute system	
		Speed-position switching control: Incremental system/absolute system	
		Position-speed switching control: Incremental system	
		Path control: Incremental system/absolute system	
	Positioning range	<p>■When using the absolute system</p> <ul style="list-style-type: none"> -214748364.8 to 214748364.7 μm -21474.83648 to 21474.83647 inch 0 to 359.99999 degree -2147483648 to 2147483647 pulse <p>■When using the incremental system</p> <ul style="list-style-type: none"> -214748364.8 to 214748364.7 μm -21474.83648 to 21474.83647 inch -21474.83648 to 21474.83647 degree -2147483648 to 2147483647 pulse <p>■When using speed-position switching control (INC mode) and position-speed switching control</p> <ul style="list-style-type: none"> 0 to 214748364.7 μm 0 to 21474.83647 inch 0 to 21474.83647 degree 0 to 2147483647 pulse <p>■When using speed-position switching mode (ABS control)^{*1}</p> <ul style="list-style-type: none"> 0 to 359.99999 degree 	
	Speed commands	0.01 to 20000000.00 mm/min 0.001 to 2000000.000 inch/min 0.001 to 3000000.000 degree/min 1 to 5000000 pulse/s	
	Acceleration/deceleration processing	Trapezoidal acceleration/deceleration, S-curve acceleration/deceleration	
	Acceleration/deceleration time	1 to 8388608 ms: both acceleration and deceleration times have 4 settable patterns	
Sudden stop deceleration time	1 to 8388608 ms		
Start time ^{*2}	1-axis linear control	0.5 ms	
	1-axis speed control	0.5 ms	
	2-axis linear interpolation control (Composite speed)	0.65 ms	
	2-axis linear interpolation control (reference axis speed)	0.65 ms	
	2-axis circular interpolation control	0.83 ms	
	2-axis speed control	0.83 ms	
Quick start function ^{*2*3}	Start with a positioning start signal	30 μs	
	Start with an external command signal	20 μs	
Start time adjustment function ^{*4}		0.00 to 10000.00 ms (in increments of 0.01 ms)	
External connection method		40-pin connector, spring clamp terminal (differential driver common terminal) ^{*5}	
Applicable power cable size	40-pin connectors	When using A6CON1 or A6CON4	Wire from 0.088 mm ² to 0.3 mm ² (AWG28 to 22)
		When using A6CON2	Wire from 0.088 mm ² to 0.24 mm ² (AWG28 to 24)
	Spring clamp terminal (differential driver common terminal)	Single wire, Strand wire (Material: Copper wire)	AWG24 to 16 (0.2 to 1.5 mm ²)
		Ferrules with insulation sleeve	AWG23 to 19 (0.25 to 0.75 mm ²)
	Ferrules without insulation sleeve	AWG23 to 16 (0.25 to 1.5 mm ²)	
External wiring connector		A6CON1, A6CON2, A6CON4 (sold separately)	
Maximum output pulse		200000 pulse/s	5000000 pulse/s
Maximum manual pulse generator input frequency		100000 pulse/s	
Manual pulse generator 1 pulse input magnification		× 1 to × 10000	
Maximum connection distance between servos		2 m	10 m
Number of write accesses to flash ROM		100000 times maximum	
Number of occupied I/O points		8 points	

Items	Specifications		
	FX5-20PG-P	FX5-20PG-D	
Applicable CPU module	<ul style="list-style-type: none"> FX5UJ CPU module (From the first) FX5U CPU module (Ver.1.050 or later) FX5UC CPU module^{*6} (Ver.1.050 or later) 		
Applicable engineering tool	FX5UJ CPU module	GX Works3 (Ver.1.060N)	
	FX5U/FX5UC CPU module	GX Works3 (Ver. 1.035M or later)	GX Works3 (Ver. 1.050C or later)

*1 Speed-position switching control (ABS mode) can be used with "degree" control units only.

*2 The positioning data analysis time depends on the operations status of its axis. This manual describes the start time and operations timing with all axis operations stopped.

*3 The "quick start function" start time is the time from when the start trigger (positioning start signal or external start command signal) is received until pulse outputs start after positioning data analysis has finished.

*4 Settable only when using the "quick start function".

*5 FX5-20PG-D only

*6 Connecting a FX5UC CPU module requires either a FX5-CNV-IFC or FX5-C1PS-5V.

2.4 External Device Output Interface Specifications

I/O signals electrical specifications

Input specifications

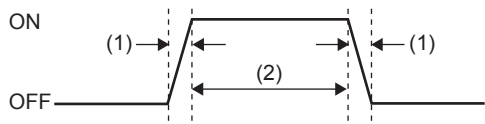
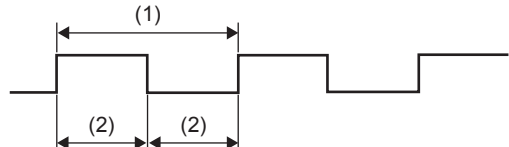
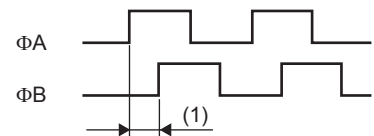
Signal name	Rated input voltage/current	Use voltage range	ON voltage/current	OFF voltage/current	Input resistance	Response time
Drive unit READY signal (READY) Stop signal (STOP) Upper limit signal (FLS) Lower limit signal (RLS)	24 V DC/5 mA	19.2 to 26.4 V DC	17.5 V DC or more/ 3.5 mA or more	7 V DC or less/ 1.7 mA or less	Approx. 4.7 kΩ	4 ms or less
Zero signal (PG05/PG024)	5 V DC/5 mA	4.5 to 6.1 V DC	2 V DC or more/ 2 mA or more	0.5 V DC or less/ 0.5 mA or less	Approx. 620Ω	1 ms or less
	24 V DC/5 mA	12 to 26.4 V DC	10 V DC or more/ 3 mA or more	3 V DC or less/ 0.2 mA or less	Approx. 4.7 kΩ	1 ms or less
 <p>(1) 3 μs or less (2) 1 ms or more</p> <p>AM26LS32 or equivalent differential receiver (ON/OFF level: ON: 1.8 V or more, OFF: 0.6 V or less)</p>						
<ul style="list-style-type: none"> With manual pulse generator connected Manual pulse generator phase A (PULSER A) Manual pulse generator phase B (PULSER B) 	5 V DC/14 mA	4.5 to 6.1 V DC	2.5 V DC or more/ 2 mA or more	1 V DC or less/ 0.2 mA or less	Approx. 1.1 kΩ	100 kHz ^{*1}
<p>■ Pulse width (50% duty ratio)</p>  <p>(1) 10 μs or more (2) 5 μs or more</p> <p>■ When the phase is ahead of the phase difference (i.e., Phase A (φA) is ahead of Phase B (φB), the positioning address (current value) increases)</p>  <p>(1) 2.5 μs or more</p>						

Signal name	Rated input voltage/ current	Use voltage range	ON voltage/ current	OFF voltage/ current	Input resistance	Response time
Near-point dog signal (DOG)	24 V DC/5 mA	19.2 to 26.4 V DC	17.5 V DC or more/ 3.5 mA or more	7 V DC or less/ 1.7 mA or less	Approx. 4.3 kΩ	1 ms or less
External command signal (CHG)	24 V DC/5 mA	19.2 to 26.4 V DC	19 V DC or more/ 2.7 mA or more	7 V DC or less/ 0.8 mA or less	Approx. 7.7 kΩ	20 μs

*1 Value of response frequency.

Output specifications

Signal name	Rated load voltage	Rated load voltage range	Max. load current/ Inrush current	Max. voltage drop when the device is turned ON	Leakage current when the device is turned OFF	Response time
Deviation counter clear signal (CLEAR)	5 to 24 V DC	4.75 to 30 V DC	0.1 A/1 point/0.4 A 10 ms or less	1.5 V DC or less	0.1 mA or less	2 ms or less (resistance load)
FX5-20PG-P • Pulse output (PULSE F) • Pulse output (PULSE R)	5 to 24 V DC	4.75 to 30 V DC	50 mA/1 point/ 200 mA 10 ms or less	1.0 V DC or less	0.1 mA or less	—
FX5-20PG-D • Pulse output F (+) (PULSE F+/-) • Pulse output R (+) (PULSE R+/-)	Differential driver equivalent to AM26C31					

■ Relationship of the pulse outputs using "[Pr.5] Pulse output mode" and "[Pr.23] Output signal logic selection"

The pulse output mode (PULSE/SIGN type, CW/CCW type, Phase A/Phase B type) can be selected using "[Pr.5] Pulse output mode" according to the drive module specifications.

Further, the output signal logic (positive or negative logic) can be selected using "[Pr.23] Output signal logic selection".

The relationship between "[Pr.5] Pulse output mode" and "[Pr.23] Output signal logic selection" is described below.

- FX5-20PG-P

This describes the voltage of the terminal using PULSE COM terminals as the standard. (☞ Page 59 Internal I/O interface circuits) (OFF→High, ON→Low)

"[Pr.5] Pulse output mode"	Terminal name	"[Pr.23] Output signal logic selection"			
		Positive logic		Negative logic	
		Forward run	Reverse run	Forward run	Reverse run
PULSE/SIGN	PULSE F	High Low		High Low	
	PULSE R	High Low		High Low	
CW/CCW	PULSE F	High Low		High Low	
	PULSE R	High Low		High Low	
Phase A/Phase B	PULSE F	High Low		High Low	
	PULSE R	High Low		High Low	

- FX5-20PG-D

As a reference, the voltage of terminals having the differential driver common terminal is shown. (Page 59 Internal I/O interface circuits)

"[Pr.5] Pulse output mode"	Terminal name	"[Pr.23] Output signal logic selection"			
		Positive logic		Negative logic	
		Forward run	Reverse run	Forward run	Reverse run
PULSE/SIGN	PULSE F+ PULSE F-	High Low High Low		High Low High Low	
	PULSE R+ PULSE R-	High Low High Low		High Low High Low	
CW/CCW	PULSE F+ PULSE F-	High Low High Low		High Low High Low	
	PULSE R+ PULSE R-	High Low High Low		High Low High Low	
Phase A/Phase B	PULSE F+ PULSE F-	High Low High Low		High Low High Low	
	PULSE R+ PULSE R-	High Low High Low		High Low High Low	

■ "[Pr.5] Pulse output mode" and "[Pr.23] Output signal logic selection"

Set the "[Pr.5] Pulse output mode" and "[Pr.23] Output signal logic selection" according to the specifications of the connected servo amplifier.

Setting the wrong connection specifications may cause the motor to operate in reverse or not operate at all.

A connection example using the MELSERVO-J4 servo amplifier is described below.

- FX5-20PG-P

"[Pr.5] Pulse output mode"	"[Pr.23] Output signal logic selection"	Servo amplifier MR-J4-□A logic	Connection example
CW/CCW	Negative logic	Negative logic	
	Positive logic	Positive logic	
PULSE/SIGN	Negative logic	Negative logic	
	Positive logic	Positive logic	
Phase A/Phase B	Negative logic	Negative logic	
	Negative logic	Positive logic	
	Positive logic	Negative logic	
	Positive logic	Positive logic	

• FX5-20PG-D

"[Pr.5] Pulse output mode"	"[Pr.23] Output signal logic selection"	Servo amplifier MR-J4-□A logic	Connection example
CW/CCW	Negative logic	Positive logic	
	Positive logic	Negative logic	
PULSE/SIGN	Negative logic	Positive logic	
	Positive logic	Negative logic	
Phase A/Phase B	Negative logic	Negative logic	
	Negative logic	Positive logic	
	Positive logic	Negative logic	
	Positive logic	Positive logic	

2.5 Part Names

Describes the names of the positioning module parts.

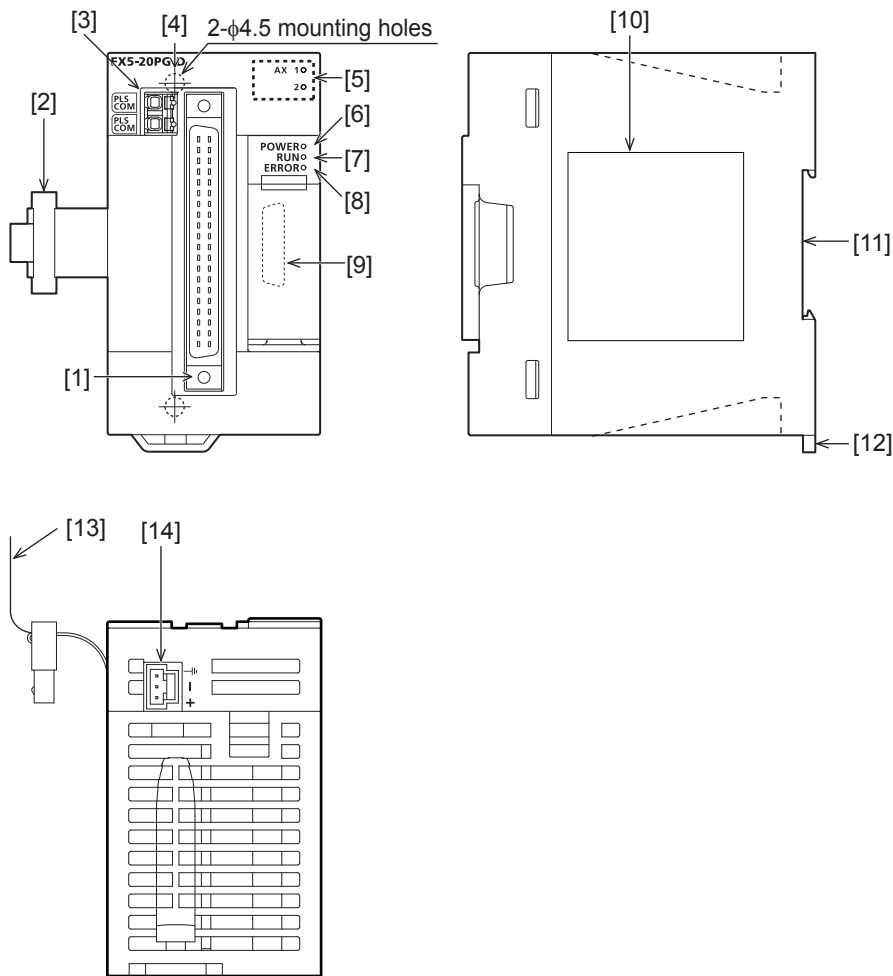

No.	Name	Description
(1)	Connector for external devices	This is the connector for connecting the drive module, mechanical inputs, and manual pulse generator. See below for the signal array. ☞ Page 56 Connector signal array for connecting external devices AX1: Axis 1, AX2: Axis 2
(2)	Expansion cable	Cable for connecting the module when adding the positioning module.
(3)	Differential driver common terminal (FX5-20PG-D only)	See the following for details. ☞ Page 50 Differential Driver Common Terminal
(4)	Direct mounting hole	Screw holes (2-φ4.5, mounting screw: M4 screw) for direct installation.
(5)	Axis display LED (AX1, AX2)	See the following for details.
(6)	POWER LED	☞ Page 26 LED display specifications
(7)	RUN LED	
(8)	ERROR LED	
(9)	Extension connector (for next module)	Connector for connecting the extension cable of an extension module.
(10)	Name plate	The product model name, and manufacturer's serial number are shown.
(11)	DIN rail mounting groove	The module can be installed on DIN46277 rail (35 mm wide).
(12)	DIN rail mounting hook	Hook for mounting the module on a DIN rail.
(13)	Pullout tab	They are used when drawing out an extension cable.
(14)	Power connector	Connector for connecting the power cable. (☞ Page 49 Power Supply Wiring)

LED display specifications

The LED display specifications are described below.

□: OFF, ■: ON, ●: Flashing (flashing interval: ON: 200 ms/OFF: 200 ms)

Positioning module status	LED display	Indication	
Power OFF	AX1□ AX2□	POWER□ RUN□ ERROR□	Positioning module power is off
Normal operation (RUN LED is ON, ERROR LED is OFF)	AX1□ AX2□	POWER■ RUN■ ERROR□	Axes stopped Axes on standby
	AX1■ AX2□	POWER■ RUN■ ERROR□	Axes in operation
Operation failure	AX1● AX2□	POWER■ RUN■ ERROR■	Minor error
	AX1□ AX2□	POWER■ RUN■ ERROR●	Moderate error
	AX1□ AX2□	POWER■ RUN□ ERROR□	Error (Initial not completed)

3 PROCEDURES BEFORE OPERATIONS

This chapter describes the procedures before operation.

1. Module mounting

Mount the positioning module to the CPU module. For details, refer to the following.

📖 MELSEC iQ-F FX5UJ User's Manual (Hardware)

📖 MELSEC iQ-F FX5U User's Manual (Hardware)

📖 MELSEC iQ-F FX5UC User's Manual (Hardware)

2. Wiring

Wire the positioning module to the external device.

3. Adding modules

Add positioning modules to the unit configuration diagram for the project using GX Works3.

4. Module settings

Set the positioning module using GX Works3.

For details, refer to  Page 324 Module Parameters.

5. Auto refresh settings

Set the refresh using GX Works3.

For details, refer to  Page 330 Refresh settings.

6. Checking connections

Check the the positioning module and the external device connections.

7. Programming

Create the program.

For details, refer to  Page 491 PROGRAMMING.

8. Test run

Check that the positioning operations operate as they have been designed.

MEMO

4 FUNCTIONS LIST

4.1 Control Functions

The positioning module has various functions. This section describes the positioning module functions using the following classifications.

Positioning functions

Positioning functions are the functions that start the positioning to the designated position using the positioning data, block start data, and conditions data.

Main functions

■OPR control

"OPR control" is the function that establishes a start point for performing the positioning control, and performs positioning toward that start point. Use to return a job that is in a position other than HOME to the home position, such as when the power is turned ON or positioning stops, etc. The "OPR controls" that are registered in the positioning module by default are as follows: "Positioning start data No. 9001 (OPR control)" and "Positioning start data No. 9002 (quick OPR control)".

■Major positioning control

This control uses the "positioning data" stored in the positioning module. The positioning controls, such as the position control and speed control, are executed by setting the required items in this positioning data and starting that positioning data. Further, this can be used to set how to control continuous positioning data (e.g., positioning data No. 1, 2, 3..., etc.) by setting the "operations pattern" in the "positioning data".

■Advanced positioning control

This control uses the "positioning data" stored in the positioning module to implement the "block start data". The applicable positioning controls can be implemented as described below.

- Several continuous positioning data are handled as a "block", and a user-defined block is implemented in the designated order.
- Implemented by adding "Conditions judgment" to the position and speed controls, etc.
- The positioning data for multiple axes start simultaneously. (The pulse is output to multiple servos simultaneously)
- The designated positioning data are implemented repeatedly.

■Manual control

The positioning module outputs user-defined pulse trains and implements control by receiving external signals input to the positioning module. Use manual control when moving a workpiece to a user-defined position (JOG operations) or micro-adjusting the positioning (inching operations, manual pulse generator operations), etc.

Sub function

Implements control compensation, limits, and adds functions, etc., when implementing the main functions.

Common functions

These implement common controls when using the positioning module, such as "Module initialization function" and "Module data backup function", etc.

4.2 Positioning Functions

A list of the positioning functions startup methods are described below.

Positioning start method	Description
Normal start	This function can start positioning controls using the simplest methods. Major positioning controls and advanced positioning controls can be started in this mode.
Quick start	This function quickly starts the positioning data that is implemented immediately afterwards using advance analysis. This function can start the major positioning controls.
Multiple axes simultaneous start	This function starts multiple axes simultaneously at the pulse output level.

4.3 Main Functions

A summary of the main positioning control functions used by the positioning module is described below.

Main functions	Description		
OPR control	Machine OPR control	Check the mechanical positioning start point using near-point dog and stopper, etc. The data set method does not generate axis travel as the current position is deemed to be the home position. (Positioning start No. 9001)	
	Fast OPR control	Moves the the OP address position ([Md.21] feeder value) stored in the positioning module according to OPR control. (Positioning start No. 9002)	
Major positioning control	Position control	Linear control <ul style="list-style-type: none"> • 1-axis linear control • 2-axis linear interpolation control 	Moves to the position specified by the travel amount and the address set in the positioning data using linear path.
		Fixed-feed control <ul style="list-style-type: none"> • 1-axis fixed-feed control • 2-axis fixed-feed control 	Moves positioning by the travel amount specified by the travel amount set in the positioning data. (In fixed amount feed control, the "[Md.20] Current feed value" is set to 0 at the start. Further, 2-axis fixed amount feed control is fed the fixed amount for a linear path by interpolation.)
		2-axis circular interpolation control	Moves to the position specified by the address, travel amount, compensation point, and center point, etc., set in the positioning data using circular path.
	Speed control	Speed control <ul style="list-style-type: none"> • 1-axis speed control • 2-axis speed control 	Continuously outputs pulses according to the designated speed set in the positioning data.
	Speed-position switching control		Performs the speed control, and then position control (Positioning with the specified address or movement amount) immediately after that by turning on speed-position switching signal.
	Position-speed switching control		Implements the initial position control, and then implements continuous speed control (i.e., continuously outputs pulses according to the designated speed) by turning ON the "position-speed switching signals".
	Other controls	Current value change	Changes the value in ([Md.20] Current feed value) to the address set in the positioning data. The following two methods can be used. (Machine feed value cannot be changed) <ul style="list-style-type: none"> • The current value is changed using positioning data • Current value change using the start No. for a current value change (No. 9003)
		NOP instruction	A control method that is not executed. If the NOP command has been set, the operation of the next data starts and the NOP command is not implemented.
JUMP instruction		Unconditionally or conditionally jumps to the specified positioning data No.	
LOOP		Implements loop control using repeated LOOP to LEND.	
LEND		Returns to the start of loop control using repeated LOOP to LEND.	

Main functions	Description	
Advanced positioning control	Block start (normal start)	With one start, executes positioning data in a block in the set order.
	Condition start	Judges the condition set in Condition data for the specified positioning data, and executes Block start data. When the condition is established, Block start data is executed. When not established, that block start data is ignored, and the block start data of the next point is implemented.
	Wait start	Judges the condition set in Condition data for the specified positioning data, and executes Block start data. When the condition is established, Block start data is executed. When not established, the control stops (waits) until the condition is established.
	Simultaneous start	Simultaneously implements the positioning data having the number for the axis specified using the conditions data. (Outputs pulses at the same timing.)
	Repeated start (FOR loop)	Repeats the program from the block start data set with FOR loop to the block start data set in NEXT for the specified number of times.
	Repeated start (FOR condition)	Repeats the program from the block start data set with FOR condition to the block start data set in NEXT until the conditions set in Condition data are established.
Manual control	JOG operation	Pulses are output to the drive module only when the JOG start signal is ON.
	Inching operation	Outputs micro travel amount pulses to the drive module using manual operations. (Implements micro-adjustments using JOG start signals)
	Manual pulse generator operation	Outputs the pulses specified by the manual pulse generator to the drive module. (Implements micro-adjustments using the pulse level)

In major positioning control (advanced positioning control), the "operation pattern" can be used to set whether or not to implement positioning data continuously. A summary of "operation patterns" is described below.

Operation pattern	Description
Independent positioning control (positioning complete)	If "Single positioning control" is set in the operation pattern for the positioning data that has started, only the specified positioning data is implemented, and then positioning ends.
Continuous positioning control	If "Continuous positioning control" is set in the operation pattern for the positioning data that has started, after the specified positioning data has been implemented, the device pauses, and then implements the next positioning data as a continuation.
Continuous path control	If "Continuous path control" is set in the operation pattern for the positioning data that has started, the specified positioning data is implemented, and then the next positioning data is implemented as a continuation without decelerating and stopping.

4.4 Sub Function, Common Function

Sub function

A summary of the sub functions used in positioning control by the positioning module is described below.

Sub function	Description	
Sub functions specific to machine OPR	OPR retry function	Retries the machine OPR with the upper/lower limit switches during the machine OPR. This allows the machine OPR to be performed even if the axis is not returned to a position before the near-point dog with operations such as the JOG operation.
	OP shift function	After the machine OPR, this function compensates the position by the specified distance from the machine OP position and sets that position as the OP address.
Function to compensate control	Backlash compensation function	Compensates the backlash amount of the machine system. Feed pulses equivalent to the set backlash amount are output each time the movement direction changes.
	Electronic gear function	By setting the movement amount per pulse, this function can freely change the machine movement amount per commanded pulse. A flexible positioning system that matches the machine system can be structured with this function by setting the travel amount per pulse.
	Near pass function ^{*1}	This function suppresses machine vibration during speed changes using continuous path control during interpolation control.
	Output timing selection of near pass control	During continuous path control, this function selects the output timing during the next positioning data implementation for the difference between the actual positioning end address and the end address set using the positioning data (Δd).
Function to limit control	Speed limit function	If the command speed exceeds [Pr.8] Speed limit value during the control, this function limits the command speed to within the setting range of [Pr.8] Speed limit value.
	Torque limit function ^{*2}	If the torque generated by the servo motor exceeds [Pr.17] Torque limit setting value during the control, this function limits the generated torque to within the setting range of [Pr.17] Torque limit setting value.
	Software stroke limit function	If a command outside of the upper/lower limit stroke limit setting range, set in the parameters, is issued, this function will not execute the positioning for that command.
	Hardware stroke limit function	Performs the deceleration stop with the limit switch connected to the positioning module's connector for external devices.
Functions that change control details	Speed change function	Changes the speed during positioning. Set the new speed in ([Cd.14] New speed value), the speed change buffer memory area, and change the speed with ([Cd.15]) Speed change request.
	Override function	Changes the speed during positioning within a percentage of 0% to 300%. Execute this function using [Cd.13] Positioning operation speed override.
	Acceleration/deceleration time change function	This function changes the acceleration and deceleration time during speed changes.
	Torque change function	Changes Torque limit value during the control.
	Target position change function	Changes the target position during positioning. The position and speed can be changed simultaneously.
Function related to positioning start	Pre-reading start function	If the positioning start is requested while Execution prohibition flag is on, no pulse is output, and when Execution prohibition flag is turned off and detected, outputting pulses is started within 0.88 ms.
	Start time adjustment function	After the start trigger was input with the quick start function, this function starts outputting pulses after the preset time has passed.
Absolute position restoration function ^{*3}		This function restores the absolute position of a specified axis.
Function related to positioning stop	Stop command processing for deceleration stop function	Selects a deceleration curve when a stop cause occurs during the deceleration stop processing to speed 0.
	Continuous operation interrupt function	Interrupts the continuous operation. When this request is accepted, the operation will stop at the completion of the positioning data being executed.
	Step function	Temporarily stops the operation to check the positioning operation during debugging and other operation. The operation can be stopped for each Automatic deceleration or Positioning data.

Sub function		Description
Other functions	Skip function	Pauses (decelerates to stop) the positioning being executed when Skip signal is input, and performs the next positioning.
	M code output function	This function implements subsidiary task commands (such as stopping clamps or drills and changing tools) corresponding to the M code numbers using the numbers 0 to 65535, which can be set for each positioning data.
	Teaching function	Stores the address positioned with the manual control in positioning address of the specified positioning data number.
	Command in-position function	This function calculates the remaining distance until the positioning module reaches the positioning stop position, and turns ON the "Command in-position flag" when the value is less than the set value. When performing another subsidiary work before the control ends, use this function as a trigger for the subsidiary work.
	Acceleration/deceleration processing function	This function adjusts the control acceleration and deceleration speeds.
	Deceleration start flag function	To inform the stop timing, this function turns on Deceleration start flag when the speed status is changed from the constant speed or acceleration to deceleration during the position control whose operation pattern is Positioning complete.
	During uncompleted OPR operation setting function	Sets whether or not to execute the positioning control when OPR request flag is on.
	Interrupt function	Generates an interrupt request to the CPU module when an interrupt factor is detected, and starts an interrupt program.

- *1 The near pass function is featured as standard and is enabled only during position control. The function cannot be set to be invalid with parameters.
- *2 To perform Torque limit, a D/A converter module and a drive unit capable of the torque limit command with an analog voltage must be needed.
- *3 An I/O module with arbitrary number of points and a drive unit capable of configuring an absolute position detection system (which is a Mitsubishi General-Purpose AC Servo and has an absolute position detection function (absolute position data transfer protocol) equivalent to that of MELSERVO-J4-□A) are needed.

Common functions

A summary of the functions that are implemented as necessary is described below.

Common functions	Description
Module data initialization function	Sets module parameters and module extension parameters (positioning data and block start data) in the buffer memory and setting values in the module extension parameter file to their factory default settings.
Module Data Backup Function	Saves the module extension parameters (positioning data and block start data) in the buffer memory currently being used in control into the module extension parameter file.
External I/O Signal Logic Switching Function	Switches I/O signal logics according to the equipment connected to the positioning module. For the system in which signals handled as normally closed contacts (such as Drive unit READY signal and limit signals) are not used, the parameter logic setting can be controlled without wiring if the setting is changed to "Positive logic".
External I/O signal monitor function	Monitors External I/O signal using the module's detailed information which can be displayed on the system monitor page of GX Works3.
History Monitor Function	Monitors the error history, warning history, and start history of all axes.
Event history function	Stores the error occurred in the positioning module in the data memory of the CPU module or the SD memory card as events.
Amplifier-less operation function	Performs positioning controls without a drive unit. This function is used for debugging user programs at start-up or simulating positioning operation.

4.5 Combining Main and Sub Functions

The positioning controls used by the positioning module implement control using a combination of main and sub functions as necessary.

- ◎: Must be combined
- : Combinations possible
- △: Combinations have limitations
- ×: Cannot be combined

Main functions		Combinations with operation patterns*1	Functions Specific to Machine OPR		
			OPR retry function	OP shift function	
OPR control	Machine OPR control	×	○	○	
	Fast OPR control	×	×	×	
Major positioning control	Position control	1-axis linear control	○	×	×
		2-axis linear interpolation control	○	×	×
		1-axis fixed-feed control	△*2	×	×
		2-axis fixed-feed control (interpolation)	△*2	×	×
		2-axis circular interpolation control	○	×	×
	Speed control (axes 1 and 2)	△*3	×	×	
	Speed-position switching control	△*2	×	×	
	Position-speed switching control	△*3	×	×	
	Other controls	Current value change	△*2	×	×
		NOP instruction	×	×	×
JUMP instruction		×	×	×	
LOOP to LEND		×	×	×	
Manual control	JOG operation, Inching operation	×	×	×	
	Manual pulse generator operation	×	×	×	

*1 The operation pattern is a setting for "positioning data".
 *2 Continuous path control settings not possible
 *3 Only independent positioning control is settable

Main functions		Function to Compensate Control				
		Backlash compensation function	Electronic gear function	Near pass function	Output timing selection of near pass control	
OPR control	Machine OPR control	○	○	*4	×	
	Fast OPR control	○	○		×	
Major positioning control	Position control	1-axis linear control	○		○	○
		2-axis linear interpolation control	○		○	○
		1-axis fixed-feed control	○		○	×
		2-axis fixed-feed control (interpolation)	○		○	×
		2-axis circular interpolation control	○		○	○
	Speed control (axes 1 and 2)	○	○		×	
	Speed-position switching control	○	○		×	
	Position-speed switching control	○	○		×	
	Other controls	Current value change	×		○	×
		NOP instruction	×		×	×
JUMP instruction		×	×		×	
LOOP to LEND		×	×		×	
Manual control	JOG operation, Inching operation	○	○	×		
	Manual pulse generator operation	○	○	×		

*4 The near pass function is a standard feature. The near pass function is enabled only when setting the continuous path control for position control operations.

Main functions		Function to limit control				
		Speed limit function	Torque limit function	Software stroke limit function	Hardware stroke limit function	
OPR control	Machine OPR control	○	○	×	⊙	
	Fast OPR control	○	○	×	⊙	
Major positioning control	Position control	1-axis linear control	○	○	○	⊙
		2-axis linear interpolation control	○	○	○	⊙
		1-axis fixed-feed control	○	○	○	⊙
		2-axis fixed-feed control (interpolation)	○	○	○	⊙
		2-axis circular interpolation control	○	○	○	⊙
	Speed control (axes 1 and 2)	○	○	○	⊙	
	Speed-position switching control	○	○	○	⊙	
	Position-speed switching control	○	○	○	⊙	
	Other controls	Current value change	×	×	○	⊙
NOP instruction		×	×	×	⊙	
JUMP instruction		×	×	×	⊙	
LOOP to LEND		×	×	×	⊙	
Manual control	JOG operation, Inching operation	○	○	×	⊙	
	Manual pulse generator operation	×	○	○	⊙	

Main functions		Functions that Change Control Details				
		Speed change function	Override function	Acceleration/ deceleration time change function	Torque change function	
OPR control	Machine OPR control	△*5	△*5	△*5	○	
	Fast OPR control	○	○	○	○	
Major positioning control	Position control	1-axis linear control	○	○	○	○
		2-axis linear interpolation control	○	○	○	○
		1-axis fixed-feed control	○	○	○	○
		2-axis fixed-feed control (interpolation)	○	○	○	○
		2-axis circular interpolation control	○	○	○	○
	Speed control (axes 1 and 2)	○	○	○	○	
	Speed-position switching control	○	○	○	○	
	Position-speed switching control	○	○	○	○	
	Other controls	Current value change	×	×	×	×
NOP instruction		×	×	×	×	
JUMP instruction		×	×	×	×	
LOOP to LEND		×	×	×	×	
Manual control	JOG operation, Inching operation	△*6	△*6	△*6	○	
	Manual pulse generator operation	×	×	×	○	

*5 Disabled during creep speed.

*6 Cannot be combined with inching operations. (Inching operations do not process acceleration and deceleration.)

Main functions		Functions that Change Control Details		Function related to positioning start			
		Target position change function	Restart function	Pre-reading start function	Start time adjustment function		
OPR control	Machine OPR control	×	×	×	×		
	Fast OPR control	×	×	×	×		
Major positioning control	Position control	1-axis linear control	△ ^{*7}	○	○	○	
		2-axis linear interpolation control	×	○	○	○	
		1-axis fixed-feed control	×	○	○	○	
		2-axis fixed-feed control (interpolation)	×	○	○	○	
		2-axis circular interpolation control	×	○	○	○	
	Speed control (axes 1 and 2)	×	○	○	○		
	Speed-position switching control	×	○	○	○		
	Position-speed switching control	×	○	○	○		
	Other controls	Current value change	×	×	×	×	
		NOP instruction	×	×	×	×	
JUMP instruction		×	×	×	×		
LOOP to LEND		×	×	×	×		
Manual control	JOG operation, Inching operation	×	×	×	×		
	Manual pulse generator operation	×	×	×	×		

*7 Disabled during continuous path control.

Main functions		Function related to positioning stop				
		Step function	Stop command processing for deceleration stop function	Continuous operation interrupt function	Stop process function	
OPR control	Machine OPR control	×	○	×	◎	
	Fast OPR control	×	○	×	◎	
Major positioning control	Position control	1-axis linear control	○	○	○	◎
		2-axis linear interpolation control	○	○	○	◎
		1-axis fixed-feed control	○	○	○	◎
		2-axis fixed-feed control (interpolation)	○	○	○	◎
		2-axis circular interpolation control	○	○	○	◎
	Speed control (axes 1 and 2)	×	○	○	◎	
	Speed-position switching control	○	○	○	◎	
	Position-speed switching control	○	○	○	◎	
	Other controls	Current value change	○	×	×	×
		NOP instruction	×	×	×	×
JUMP instruction		×	×	×	×	
LOOP to LEND		×	×	×	×	
Manual control	JOG operation, Inching operation	×	×	×	△ ^{*8}	
	Manual pulse generator operation	×	×	×	◎	

*8 Cannot be combined with inching operations. (Inching operations do not process acceleration and deceleration.)

Main functions		Other functions				
		Skip function	M code output function	Teaching function	Command in-position function	
OPR control	Machine OPR control	×	×	×	×	
	Fast OPR control	×	×	×	×	
Major positioning control	Position control	1-axis linear control	○	○	×	○
		2-axis linear interpolation control	○	○	×	○
		1-axis fixed-feed control	○	○	×	○
		2-axis fixed-feed control (interpolation)	○	○	×	○
		2-axis circular interpolation control	○	○	×	○
	Speed control (axes 1 and 2)	×	○	×	×	
	Speed-position switching control	○	○	×	○	
	Position-speed switching control	×	○	×	○	
	Other controls	Current value change	○	△ ^{*9}	×	×
		NOP instruction	×	×	×	×
JUMP instruction		×	×	×	×	
LOOP to LEND		×	×	×	×	
Manual control	JOG operation, Inching operation	×	×	○	×	
	Manual pulse generator operation	×	×	○	×	

*9 Implement by changing the current value used in the positioning data. Starting using positioning start No. 9003 is not possible.

Main functions		Other functions				
		Acceleration/deceleration processing function	Deceleration start flag function	During uncompleted OPR operation setting function	Interrupt function ^{*13}	
OPR control	Machine OPR control	○	×	×	○	
	Fast OPR control	○	×	×	○	
Major positioning control	Position control	1-axis linear control	○	○	○	○
		2-axis linear interpolation control	○	△ ^{*11}	○	○
		1-axis fixed-feed control	○	○	○	○
		2-axis fixed-feed control (interpolation)	○	△ ^{*11}	○	○
		2-axis circular interpolation control	○	×	○	○
	Speed control (axes 1 and 2)	○	×	○	○	
	Speed-position switching control	○	△ ^{*12}	○	○	
	Position-speed switching control	○	△ ^{*12}	○	○	
	Other controls	Current value change	×	×	○	○
		NOP instruction	×	×	×	○
JUMP instruction		×	×	×	○	
LOOP to LEND		×	×	×	○	
Manual control	JOG operation, Inching operation	△ ^{*10}	×	×	○	
	Manual pulse generator operation	×	×	×	○	

*10 Cannot be combined with inching operations. (Inching operations do not process acceleration and deceleration.)

*11 Enabled for reference axes only.

*12 Enabled only when starting deceleration during position control.

*13 There are no limits to combinations with other functions. Identifying the establishment of interrupt conditions is performed at any time.

4.6 Combining Various Sub Functions

A list of the various sub function combinations during one main function control is described below.

- : Combinations possible
- △: Combinations have limitations
- ×: Cannot be combined

Function name		Combinable sub functions			
		OPR retry function	OP shift function	Backlash compensation function	Electronic gear function
Functions specific to machine OPR	OPR retry function	—	○	○	○
	OP shift function	○	—	○	○
Function to compensate control	Backlash compensation function	○	○	—	○
	Electronic gear function	○	○	○	—
	Near pass function	×	×	○	○
	Output timing selection of near pass control	×	×	○	○
Function to limit control	Speed limit function	○	○	○	○
	Torque limit function	○	○	○	○
	Software stroke limit function	×	×	○	○
	Hardware stroke limit function	○	○	○	○
Functions that change control details	Speed change function	△ ^{*1}	△ ^{*1}	○	○
	Override function	△ ^{*1}	△ ^{*1}	○	○
	Acceleration/deceleration time change function	○	○	○	○
	Torque change function	○	○	○	○
	Target position change function	×	×	○	○
Function related to positioning start	Start time adjustment function	×	×	○	○
	Restart function	×	×	○	○
	Pre-reading start function	×	×	○	○
Absolute position restoration function		×	×	○	○
Function related to positioning stop	Step function	×	×	○	○
	Stop command processing for deceleration stop function	×	×	○	○
	Continuous operation interrupt function	×	×	○	○
	Stop process function	○	○	○	○
Other functions	Skip function	×	×	○	○
	M code output function	×	×	○	○
	Teaching function	×	×	×	×
	Command in-position function	×	×	○	○
	Acceleration/deceleration processing function	○	○	○	○
	Deceleration start flag function	×	×	○	○
	During uncompleted OPR operation setting function	○	○	○	○
Interrupt function ^{*2}	○	○	○	○	

*1 Speed cannot be changed to 0.

*2 There are no limits to combinations with other functions. Identifying the establishment of interrupt conditions is performed at any time.

Function name		Combinable sub functions			
		Near pass function	Output timing selection of near pass control	Speed limit function	Torque limit function
Functions specific to machine OPR	OPR retry function	×	×	○	○
	OP shift function	×	×	○	○
Function to compensate control	Backlash compensation function	○	○	○	○
	Electronic gear function	○	○	○	○
	Near pass function	—	○	○	○
	Output timing selection of near pass control	○	—	○	○
Function to limit control	Speed limit function	○	○	—	○
	Torque limit function	○	○	○	—
	Software stroke limit function	○	○	○	○
	Hardware stroke limit function	○	○	○	○
Functions that change control details	Speed change function	○	○	○	○
	Override function	○	○	○	○
	Acceleration/deceleration time change function	○	○	○	○
	Torque change function	○	○	○	○
	Target position change function	○	○	○	○
Function related to positioning start	Start time adjustment function	○	○	○	○
	Restart function	○	○	○	○
	Pre-reading start function	○	○	○	○
Absolute position restoration function		×	×	×	×
Function related to positioning stop	Step function	○	○	○	○
	Stop command processing for deceleration stop function	○	○	○	○
	Continuous operation interrupt function	○	○	○	○
	Stop process function	○	○	○	○
Other functions	Skip function	○	○	○	○
	M code output function	○	○	○	○
	Teaching function	×	×	×	×
	Command in-position function	○	○	○	○
	Acceleration/deceleration processing function	○	○	○	○
	Deceleration start flag function	○	○	○	○
	During uncompleted OPR operation setting function	○	○	○	○
	Interrupt function ^{*3}	○	○	○	○

*3 There are no limits to combinations with other functions. Identifying the establishment of interrupt conditions is performed at any time.

Function name		Combinable sub functions			
		Software stroke limit function	Hardware stroke limit function	Speed change function	Override function
Functions specific to machine OPR	OPR retry function	×	○	△ ^{*4}	△ ^{*4}
	OP shift function	×	○	△ ^{*4}	△ ^{*4}
Function to compensate control	Backlash compensation function	○	○	○	○
	Electronic gear function	○	○	○	○
	Near pass function	○	○	○	○
	Output timing selection of near pass control	○	○	○	○
Function to limit control	Speed limit function	○	○	○	○
	Torque limit function	○	○	○	○
	Software stroke limit function	—	○	○	○
	Hardware stroke limit function	○	—	○	○
Functions that change control details	Speed change function	○	○	—	○
	Override function	○	○	○	—
	Acceleration/deceleration time change function	○	○	○	○
	Torque change function	○	○	○	○
	Target position change function	○	○	○	○
Function related to positioning start	Start time adjustment function	○	○	○	○
	Restart function	○	○	○	○
	Pre-reading start function	○	○	○	○
Absolute position restoration function		×	×	×	×
Function related to positioning stop	Step function	○	○	○	○
	Stop command processing for deceleration stop function	○	○	○	○
	Continuous operation interrupt function	○	○	○	○
	Stop process function	○	○	○	○
Other functions	Skip function	○	○	△ ^{*5}	○
	M code output function	○	○	○	○
	Teaching function	×	×	×	×
	Command in-position function	○	○	○	○
	Acceleration/deceleration processing function	○	○	○	○
	Deceleration start flag function	○	○	△ ^{*6}	△ ^{*6}
	During uncompleted OPR operation setting function	○	○	○	○
	Interrupt function ^{*7}	○	○	○	○

*4 Speed cannot be changed to 0.

*5 Controls that use external command signals can be used with only of several functions only.

*6 When decelerating due to speed changes or overrides, the deceleration start flag does not turn ON.

*7 There are no limits to combinations with other functions. Identifying the establishment of interrupt conditions is performed at any time.

Function name		Combinable sub functions			
		Acceleration/ deceleration time change function	Torque change function	Target position change function	Start time adjustment function
Functions specific to machine OPR	OPR retry function	○	○	×	×
	OP shift function	○	○	×	×
Function to compensate control	Backlash compensation function	○	○	○	○
	Electronic gear function	○	○	○	○
	Near pass function	○	○	○	○
	Output timing selection of near pass control	○	○	○	○
Function to limit control	Speed limit function	○	○	○	○
	Torque limit function	○	○	○	○
	Software stroke limit function	○	○	○	○
	Hardware stroke limit function	○	○	○	○
Functions that change control details	Speed change function	○	○	○	○
	Override function	○	○	○	○
	Acceleration/deceleration time change function	—	○	○	○
	Torque change function	○	—	○	○
	Target position change function	○	○	—	○
Function related to positioning start	Start time adjustment function	○	○	○	—
	Restart function	○	○	○	×
	Pre-reading start function	○	○	○	×
Absolute position restoration function		×	×	×	×
Function related to positioning stop	Step function	○	○	○	○
	Stop command processing for deceleration stop function	○	○	○	○
	Continuous operation interrupt function	○	○	○	○
	Stop process function	○	○	○	○
Other functions	Skip function	○	○	○	○
	M code output function	○	○	○	○
	Teaching function	×	×	×	×
	Command in-position function	○	○	○	○
	Acceleration/deceleration processing function	○	○	○	○
	Deceleration start flag function	○	○	○	○
	During uncompleted OPR operation setting function	○	○	○	○
	Interrupt function*8	○	○	○	○

*8 There are no limits to combinations with other functions. Identifying the establishment of interrupt conditions is performed at any time.

Function name		Combinable sub functions			
		Restart function	Pre-reading start function	Absolute position restoration function	Step function
Functions specific to machine OPR	OPR retry function	×	×	×	×
	OP shift function	×	×	×	×
Function to compensate control	Backlash compensation function	○	○	×	○
	Electronic gear function	○	○	○	○
	Near pass function	○	○	×	○
	Output timing selection of near pass control	○	○	×	○
Function to limit control	Speed limit function	○	○	×	○
	Torque limit function	○	○	×	○
	Software stroke limit function	○	○	×	○
	Hardware stroke limit function	○	○	×	○
Functions that change control details	Speed change function	○	○	×	○
	Override function	○	○	×	○
	Acceleration/deceleration time change function	○	○	×	○
	Torque change function	○	○	×	○
	Target position change function	○	○	×	○
Function related to positioning start	Start time adjustment function	×	×	×	○
	Restart function	—	×	×	○
	Pre-reading start function	×	—	×	○
Absolute position restoration function		×	×	—	×
Function related to positioning stop	Step function	○	○	×	—
	Stop command processing for deceleration stop function	○	○	×	○
	Continuous operation interrupt function	○	○	×	○
	Stop process function	○	○	×	○
Other functions	Skip function	○	○	×	○
	M code output function	○	○	×	○
	Teaching function	×	×	×	×
	Command in-position function	○	○	×	○
	Acceleration/deceleration processing function	○	○	×	○
	Deceleration start flag function	○	○	×	○
	During uncompleted OPR operation setting function	○	○	×	○
Interrupt function* ⁹	○	○	○	○	

*⁹ There are no limits to combinations with other functions. Identifying the establishment of interrupt conditions is performed at any time.

Function name		Combinable sub functions			
		Stop command processing for deceleration stop function	Continuous operation interrupt function	Stop process function	Skip function
Functions specific to machine OPR	OPR retry function	×	×	○	×
	OP shift function	×	×	○	×
Function to compensate control	Backlash compensation function	○	○	○	○
	Electronic gear function	○	○	○	○
	Near pass function	○	○	○	○
	Output timing selection of near pass control	○	○	○	○
Function to limit control	Speed limit function	○	○	○	○
	Torque limit function	○	○	○	○
	Software stroke limit function	○	○	○	○
	Hardware stroke limit function	○	○	○	○
Functions that change control details	Speed change function	○	○	○	△ ^{*10}
	Override function	○	○	○	○
	Acceleration/deceleration time change function	○	○	○	○
	Torque change function	○	○	○	○
	Target position change function	○	○	○	○
Function related to positioning start	Start time adjustment function	○	○	○	○
	Restart function	○	○	○	○
	Pre-reading start function	○	○	○	○
Absolute position restoration function		×	×	×	×
Function related to positioning stop	Step function	○	○	○	○
	Stop command processing for deceleration stop function	—	○	○	○
	Continuous operation interrupt function	○	—	○	○
	Stop process function	○	○	—	○
Other functions	Skip function	○	○	○	—
	M code output function	○	○	○	△ ^{*11}
	Teaching function	×	×	×	×
	Command in-position function	○	○	○	○
	Acceleration/deceleration processing function	○	○	○	○
	Deceleration start flag function	○	○	○	○
	During uncompleted OPR operation setting function	○	○	○	○
	Interrupt function ^{*12}	○	○	○	○

*10 Controls that use external command signals can be used with only of several functions only.

*11 M code ON signal ([Md.31] Status: b12) does not turn ON when the M code output is set to the AFTER mode (When 1: AFTER mode is set in [Pr.18] M code ON signal output timing).

*12 There are no limits to combinations with other functions. Identifying the establishment of interrupt conditions is performed at any time.

Function name		Combinable sub functions			
		M code output function	Teaching function	Command in-position function	Acceleration/deceleration processing function
Functions specific to machine OPR	OPR retry function	×	×	×	○
	OP shift function	×	×	×	○
Function to compensate control	Backlash compensation function	○	×	○	○
	Electronic gear function	○	×	○	○
	Near pass function	○	×	○	○
	Output timing selection of near pass control	○	×	○	○
Function to limit control	Speed limit function	○	×	○	○
	Torque limit function	○	×	○	○
	Software stroke limit function	○	×	○	○
	Hardware stroke limit function	○	×	○	○
Functions that change control details	Speed change function	○	×	○	○
	Override function	○	×	○	○
	Acceleration/deceleration time change function	○	×	○	○
	Torque change function	○	×	○	○
	Target position change function	○	×	○	○
Function related to positioning start	Start time adjustment function	○	×	○	○
	Restart function	○	×	○	○
	Pre-reading start function	○	×	○	○
Absolute position restoration function		×	×	×	×
Function related to positioning stop	Step function	○	×	○	○
	Stop command processing for deceleration stop function	○	×	○	○
	Continuous operation interrupt function	○	×	○	○
	Stop process function	○	×	○	○
Other functions	Skip function	△ ^{*13}	×	○	○
	M code output function	—	×	○	○
	Teaching function	×	—	×	×
	Command in-position function	○	×	—	○
	Acceleration/deceleration processing function	○	×	○	—
	Deceleration start flag function	○	×	○	○
	During uncompleted OPR operation setting function	○	×	○	○
	Interrupt function ^{*14}	○	○	○	○

*13 M code ON signal ([Md.31] Status: b12) does not turn ON when the M code output is set to the AFTER mode (When 1: AFTER mode is set in [Pr.18] M code ON signal output timing).

*14 There are no limits to combinations with other functions. Identifying the establishment of interrupt conditions is performed at any time.

Function name		Combinable sub functions		
		Deceleration start flag	During uncompleted OPR operation setting function	Interrupt function
Functions specific to machine OPR	OPR retry function	×	○	○
	OP shift function	×	○	○
Function to compensate control	Backlash compensation function	○	○	○
	Electronic gear function	○	○	○
	Near pass function	○	○	○
	Output timing selection of near pass control	○	○	○
Function to limit control	Speed limit function	○	○	○
	Torque limit function	○	○	○
	Software stroke limit function	○	○	○
	Hardware stroke limit function	○	○	○
Functions that change control details	Speed change function	△ ^{*15}	○	○
	Override function	△ ^{*15}	○	○
	Acceleration/deceleration time change function	○	○	○
	Torque change function	○	○	○
	Target position change function	○	○	○
Function related to positioning start	Start time adjustment function	○	○	○
	Restart function	○	○	○
	Pre-reading start function	○	○	○
Absolute position restoration function		×	×	○
Function related to positioning stop	Step function	○	○	○
	Stop command processing for deceleration stop function	○	○	○
	Continuous operation interrupt function	○	○	○
	Stop process function	○	○	○
Other functions	Skip function	○	○	○
	M code output function	○	○	○
	Teaching function	×	×	○
	Command in-position function	○	○	○
	Acceleration/deceleration processing function	○	○	○
	Deceleration start flag function	—	○	○
	During uncompleted OPR operation setting function	○	—	○
	Interrupt function ^{*16}	○	○	—

*15 When decelerating due to speed changes or overrides, the deceleration start flag does not turn ON.

*16 There are no limits to combinations with other functions. Identifying the establishment of interrupt conditions is performed at any time.

5 SYSTEM CONFIGURATION

Describes the configuration functions when using the positioning module.

See the following for the PLC system configuration.

📖 MELSEC iQ-F FX5UJ User's Manual (Hardware)

📖 MELSEC iQ-F FX5U User's Manual (Hardware)

📖 MELSEC iQ-F FX5UC User's Manual (Hardware)

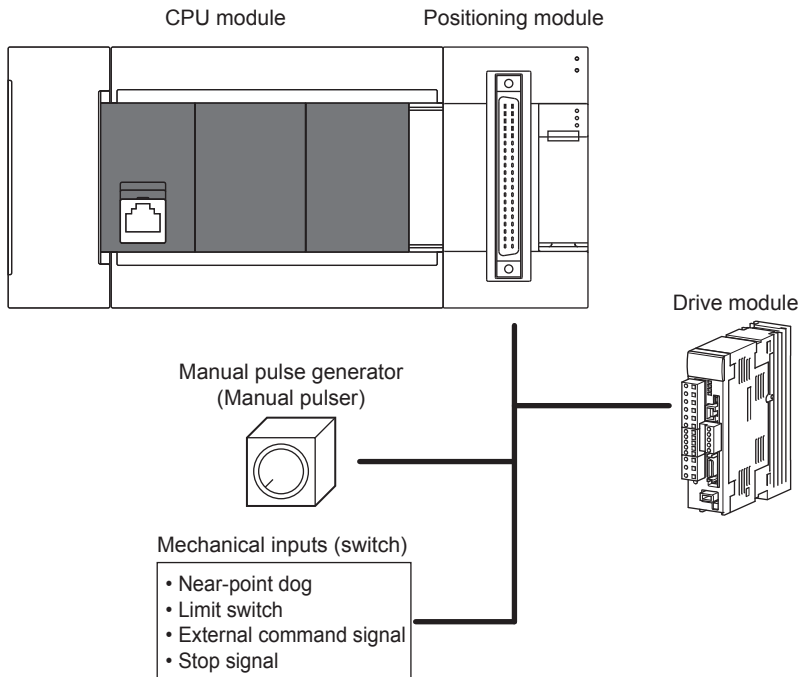

MEMO

6 WIRING

This section explains the wiring methods, wiring parts, and wiring precautions when using the positioning module.

6.1 Power Supply Wiring

Power connector array

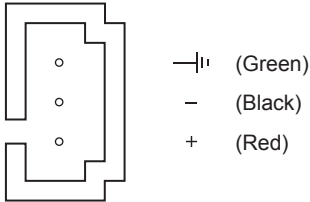

Power supply wiring

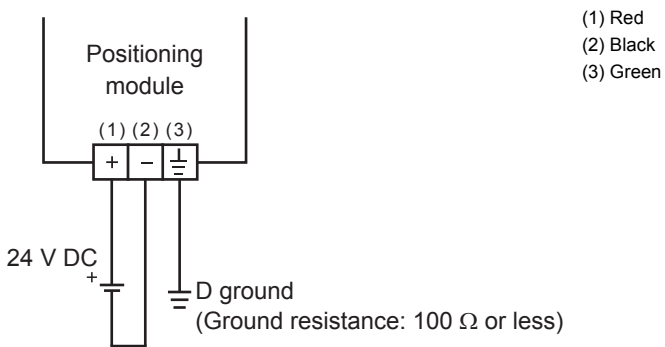

6

Grounding

Ground the PLC as stated below.

- Perform class D grounding. (Grounding resistance: 100 Ω or less)
- Ground the PLC independently if possible.
- If the PLC cannot be grounded independently, perform the "Shared grounding" shown below.

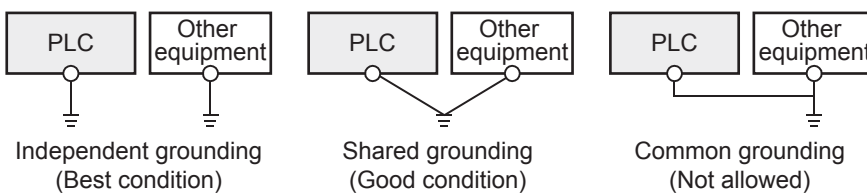

- Bring the grounding point close to the PLC as much as possible so that the ground cable can be shortened.

6.2 Differential Driver Common Terminal

The differential driver common terminal of the FX5-20PG-D is a spring clamp terminal block.

Signal array

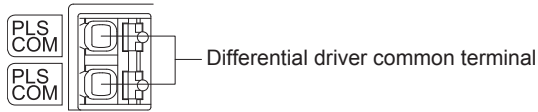

Signal name	Signal details
PLS COM	The potential difference between the common of differential driver of the FX5-20PG-D and the common of the differential receiver of the drive unit (differential driver compatible) is equalized.

Suitable wiring

The wires to connect the spring clamp terminal block are described below.

No. of wire per terminal	Wire size		
	Single wire, strand wire	Ferrule with insulation sleeve	Ferrules without insulation sleeve
One wiring	AWG24 to 16 (0.2 to 1.5mm ²)	AWG23 to 19 (0.25 to 0.75mm ²)	AWG23 to 16 (0.25 to 1.5mm ²)

Wire end treatment

Strip the cable about 10 mm from the tip to connect a wire ferrule at the stripped area. Failure to do so may result in electric shock or short circuit between adjacent terminals because the conductive part. If the wire strip length is too short, it may result in the poor contact to the spring clamp terminal part.

Depending on the thickness of the sheath, it may be difficult to insert into the insulation sleeve, so select the wires by referring to the appearance diagram.

Strand wire/single wire	Ferrule with insulation sleeve

Check the shape of the wire insertion opening with the following chart, and use the smaller wire ferrule than the described size. Also, insert the wire with care so that the wire ferrule is in proper orientation. Failure to do so may cause the bite of the terminal and the damage of the terminal block.

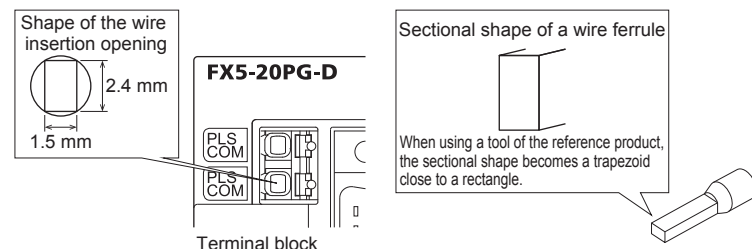

The following table shows wire ferrules and its associated tools compatible with the terminal block. The shape of the wire ferrule differs depending on the crimp tool to be used, use the reference product. If the product other than referenced products is used, the wire ferrule cannot be removed. Sufficiently confirm that the wire ferrule can be removed before use.

<Reference product>

Manufacturer	Sleeve	Ferrules model	Suitable wiring size	Crimp tool
PHOENIX-CONTACT GmbH & Co. KG	Ferrules with insulation sleeve	AI 0.25-8 YE	0.25 mm ²	CRIMPFOX 6
		AI 0.34-8 TQ	0.3, 0.34 mm ²	
		AI 0.5-8 WH	0.5 mm ²	
		AI 0.75-8 GY	0.75 mm ²	
	Ferrules without insulation sleeve	A 0,25-7	0.25 mm ²	
		A 0,34-7	0.3, 0.34 mm ²	
		A 0,5-8	0.5 mm ²	
		A 0,75-8	0.75 mm ²	
		AI 1.0-8	1.0 mm ²	
		AI 1.5-7	1.25, 1.5 mm ²	

Connection and disconnection of the cable

■ Connection of the cable

Fully insert a cable whose end has been properly processed into the wire insertion opening.

If the cable cannot be inserted with this procedure, fully insert the cable while pushing the open/close button with a flathead screwdriver having a tip width of 2.0 to 2.5 mm. After fully inserting the cable, remove the screwdriver.

<Reference>

Manufacturer	Model
PHOENIX-CONTACT GmbH & Co. KG	SZS 0.4 × 2.5 VDE

6

Precautions

Pull the cable or wire ferrule slightly to check that the cable is securely clamped.

■ Disconnection of the cable

Push the open/close button of the wire to be disconnected with a flathead screwdriver. Pull out the wire with the open/close button pushed.

6.3 Connector Wiring

This section explains the connectors for connecting external devices. See below for the terminal array.

☞ Page 56 Connector for Connecting External Devices

Precautions

Check the terminal array before wiring the positioning module correctly.

Usable connectors

Use the connectors specified by the user for connecting external devices used by the positioning module.

The connector types and recommended crimping tools are described below.

40-pin connector

Type	Model	Applicable power cable size
Soldered type connector (straight protrusion)	A6CON1*1	0.088 to 0.3 mm ² (AWG28 to 22) (from the wire)
Crimped type connector (straight protrusion)	A6CON2	0.088 to 0.24 mm ² (AWG28 to 24) (from the wire)
Soldered type connector (both straight/inclined protrusion type)	A6CON4*1	0.088 to 0.3 mm ² (AWG28 to 22) (from the wire)

*1 Use wires with a covering diameter of 1.3 mm or less when using 40 pins.
Select wires according to the current value in use.

Precautions

A6CON3 (crimped type connector (straight protrusion)) cannot be used.

40-pin connector crimping tool

Type	Model	Inquiries
Crimping tool	FCN-363T-T005/H	FUJITSU COMPONENT LIMITED

Ask FUJITSU COMPONENT LIMITED about the connector wiring methods and crimping tool use methods.

Connector wiring methods

For A6CON1 and A6CON4

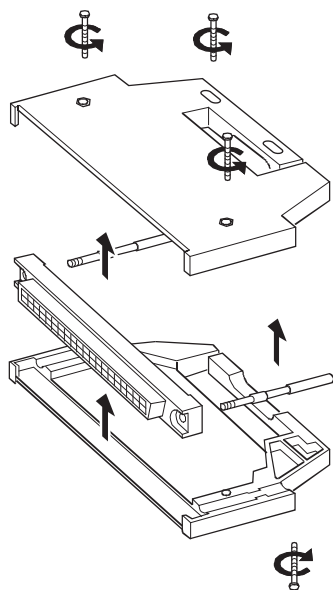

1. Loosen and remove the 4 connector screws. Next, open the connector cover from the connector side.

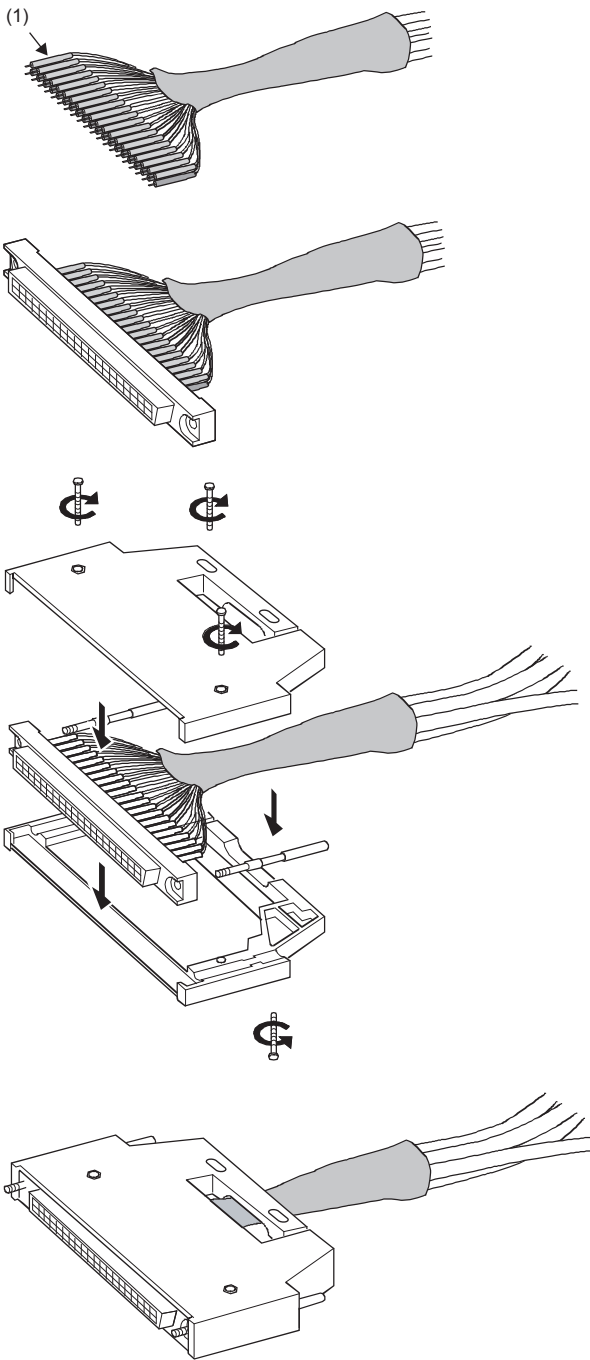

2. Solder the wires, and cover the heat-shrinking tubing (1).

3. Check the terminal array, and wire to the connector. If the connector is connected to an I/O module, it is not necessary to connect the FG wires.

4. Insert the connector into one side of the connector cover, and pass the securing screws all the way through. Then close the other side of the connector cover.

5. Tighten the 4 screws.

For A6CON2

This section describes the FCN-363T-T005/H specifications used by A6CON2.

Applicable wire size	Wire cross-section area	Crimp height	Wire cover diameter	Stripped wire length
AWG24	0.20 to 0.24 mm ²	1.25 to 1.30	φ1.2 or less	3.0 to 4.0
AWG26	0.13 to 0.16 mm ²	1.20 to 1.25	φ1.2 or less	3.0 to 4.0
AWG28	0.088 to 0.096 mm ²	1.15 to 1.20	φ1.2 or less	3.0 to 4.0

Special tools are required for A6CON2 wires.

Ask FUJITSU COMPONENT LIMITED about the tool use methods and adjustments.

Array the flat cables in the order described below.

A1→B1→A2→.....

(The diagram below shows the view from the connector insertion aperture)

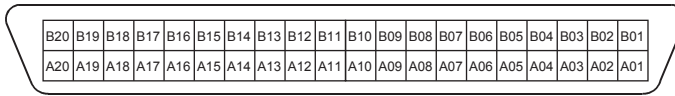

Connecting the connectors

Mounting order

1. Connect the wired connector to the module insertion aperture.

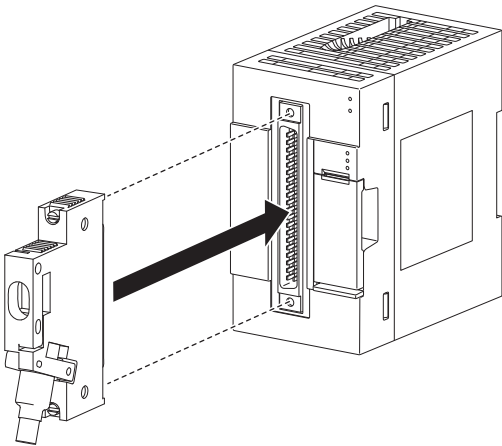

2. Tighten the connector mounting screws × 2 (M2.6 screws) (1).

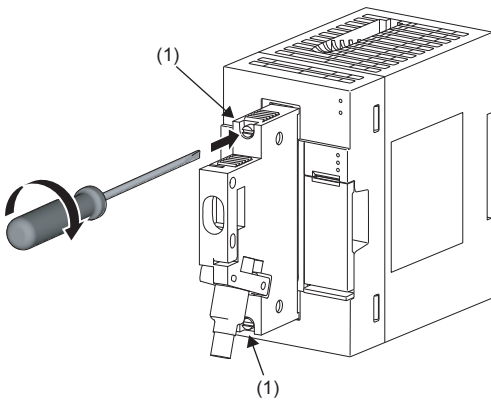

Removal method

When removing, loosen the connector mounting screws × 2, and pull out the connector horizontal to the module.

Wiring example when using shielded cables

A wiring example for noise countermeasures if using the A6CON1 connector is described below.

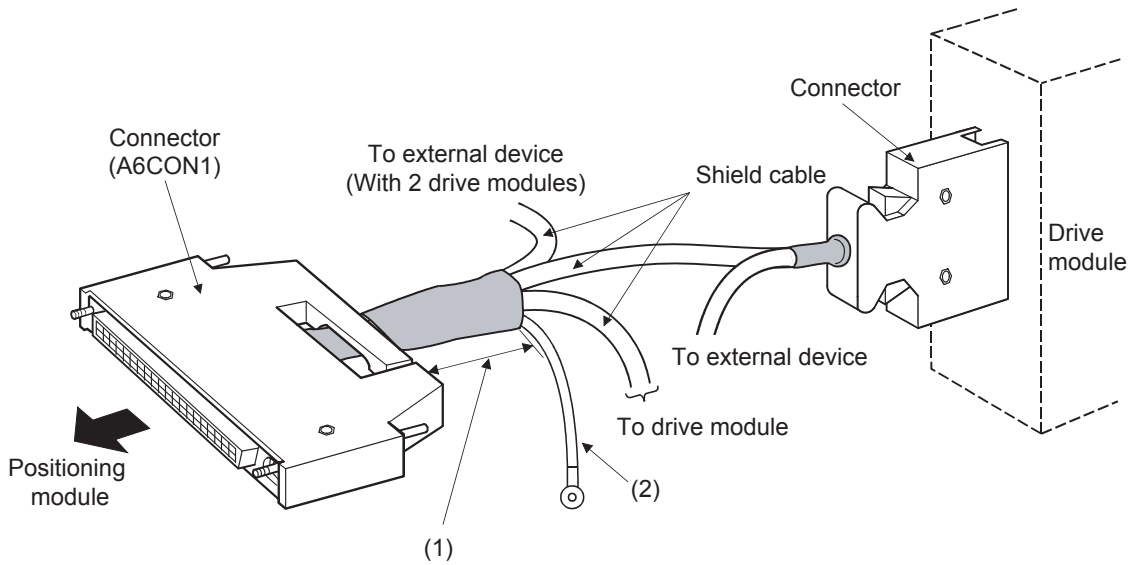

- (1) Minimize the distance between the connector and the shielded cable.
- (2) Ground the FG wires of 2 mm² min. using the minimum distance. (Securely ground to the base on the positioning module side.)

Shielded cable processing example

A wiring example for noise countermeasures if using the A6CON1 connector is described below.

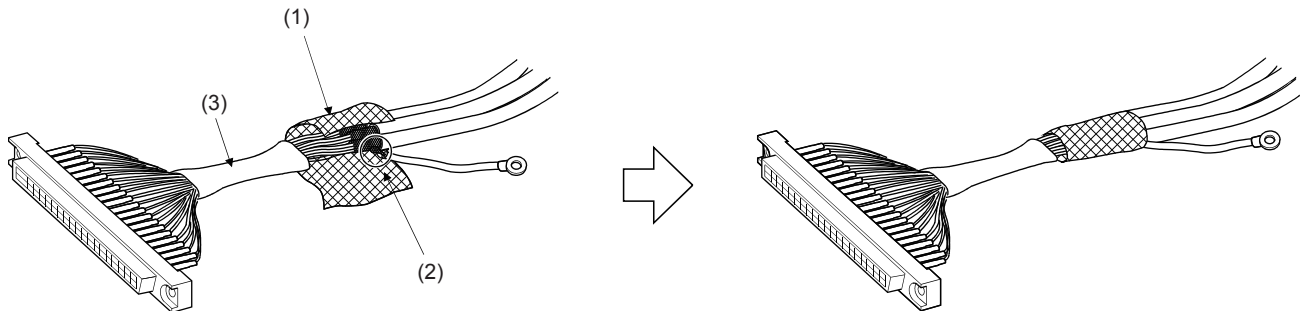

- (1) Strip the outer covering of each shield, and connect the shielded cable shields using conductive tape.
- (2) Remove the shielded from any one of the shielded cables, and solder to the FG wires.
- (3) Cover using electrical tape.

Connector (A6CON1) assembly

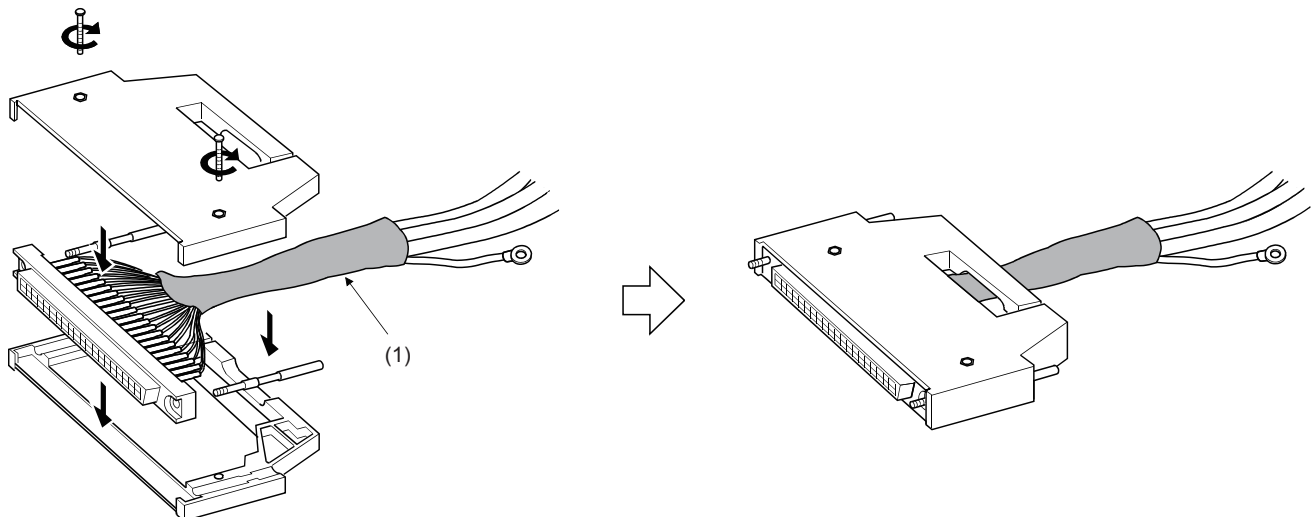

- (1) Cover each conducting tape using heat-shrinkable tubing.

Precautions

- Correctly solder or crimp the connectors for connecting external devices (A6CON□).
- Securely connect the connectors for connecting external devices (A6CON□) to the module, and tighten the screws (x2).
- Tighten the connector mounting screws within the tightening range described below.

Screws	Tightening range
Connector mounting screws (M2.6 screws)	0.20 to 0.29 N-m

- Place the cables in a duct or clamp them. If not, dangling cable may swing or inadvertently be pulled, resulting in damage to the module or cables or malfunction due to poor contact.
- Use copper wires with a rated temperature of 80 °C or less to connect to the module.
- If UL conformance is required, use UL-approved connectors.

Point

See the following for compatibility with EMC and low voltage directives.

☞ Page 547 Standards

Further, it may be possible to reduce the effects of external noise using conforming configurations even if conformance to EMC and low voltage directives is not required.

6.4 Connector for Connecting External Devices

Connector signal array for connecting external devices

The connector signal array for connecting external positioning module devices is described below.

FX5-20PG-P

Pin layout (seen from the front of the unit)	Axis 2 (AX2)		Axis 1 (AX1)	
	Pin No.	Signal name	Pin No.	Signal name
B20 □ □ A20	B20	PULSER B-	A20	PULSER B+
B19 □ □ A19	B19	PULSER A-	A19	PULSER A+
B18 □ □ A18	B18	PULSE COM	A18	PULSE COM
B17 □ □ A17	B17	PULSE R	A17	PULSE R
B16 □ □ A16	B16	PULSE COM	A16	PULSE COM
B15 □ □ A15	B15	PULSE F	A15	PULSE F
B14 □ □ A14	B14	CLRCOM	A14	CLRCOM
B13 □ □ A13	B13	CLEAR	A13	CLEAR
B12 □ □ A12	B12	RDYCOM	A12	RDYCOM
B11 □ □ A11	B11	READY	A11	READY
B10 □ □ A10	B10	PG0COM	A10	PG0COM
B9 □ □ A9	B9	PG05	A9	PG05
B8 □ □ A8	B8	PG024	A8	PG024
B7 □ □ A7	B7	COM	A7	COM
B6 □ □ A6	B6	COM	A6	COM
B5 □ □ A5	B5	CHG	A5	CHG
B4 □ □ A4	B4	STOP	A4	STOP
B3 □ □ A3	B3	DOG	A3	DOG
B2 □ □ A2	B2	RLS	A2	RLS
B1 □ □ A1	B1	FLS	A1	FLS

FX5-20PG-D

Pin layout (seen from the front of the unit)	Axis 2 (AX2)		Axis 1 (AX1)	
	Pin No.	Signal name	Pin No.	Signal name
B20		PULSER B-	A20	PULSER B+
B19		PULSER A-	A19	PULSER A+
B18		PULSE R-	A18	PULSE R-
B17		PULSE R+	A17	PULSE R+
B16		PULSE F-	A16	PULSE F-
B15		PULSE F+	A15	PULSE F+
B14		CLRCOM	A14	CLRCOM
B13		CLEAR	A13	CLEAR
B12		RDYCOM	A12	RDYCOM
B11		READY	A11	READY
B10		PG0COM	A10	PG0COM
B9		PG05	A9	PG05
B8		PG024	A8	PG024
B7		COM	A7	COM
B6		COM	A6	COM
B5		CHG	A5	CHG
B4		STOP	A4	STOP
B3		DOG	A3	DOG
B2		RLS	A2	RLS
B1		FLS	A1	FLS

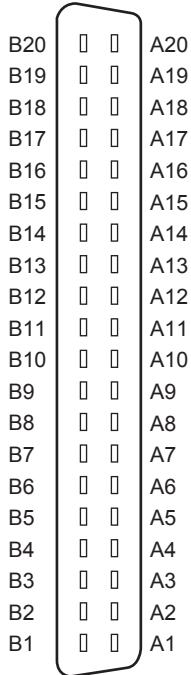

List of I/O signal detail

Signal name	Axis No.		Signal details (External I/O signals logic selection is negative logic)	
	Axis 1	Axis 2		
Manual pulse generator phase A (PULSER A+)	A19	—	<ul style="list-style-type: none"> Inputs manual pulse generator phases A and B pulse signals. The phases rise when phase A (ϕA) is ahead of phase B (ϕB), and lower when the positioning address (P_a) increases. The phases rise when phase B (ϕB) is ahead of phase A (ϕA), and lower when the positioning address (P_a) decreases. <p>(During increase)</p> <p>(During decrease)</p>	
Manual pulse generator phase B (PULSER B+)	A20	—		
Manual pulse generator common A (PULSER A-)	—	B19		
Manual pulse generator common B (PULSER B-)	—	B20		
Zero signal (+24 V) (PG024)	A8	B8	<ul style="list-style-type: none"> Inputs home signals during machine OPR. Uses pulse encoder zero signals, etc. Also uses these signals if entering external OPR complete while the machine OPR method stopper is stopped. Detects zero signals using OFF→ON. 	
Zero signal (+5 V) (PG05)	A9	B9		
Zero signal common (PG0COM)	A10	B10		
Pulse output F (PULSE F)	A15	B15	Outputs Pulses and pulse symbols for positioning the drive module corresponding to the transistor outputs. (FX5-20PG-P only)	
Pulse output F common (PULSE COM)	A16	B16		
Pulse output R (PULSE R)	A17	B17		
Pulse output R common (PULSE COM)	A18	B18		
Pulse output F (+) (PULSE F+)	A15	B15		The positioning pulses and pulse codes are output to the drive unit compatible with the differential driver output system. (FX5-20PG-D only)
Pulse output F (-) (PULSE F-)	A16	B16		
Pulse output R (+) (PULSE R+)	A17	B17		
Pulse output R (-) (PULSE R-)	A18	B18		

Signal name	Axis No.		Signal details (External I/O signals logic selection is negative logic)
	Axis 1	Axis 2	
Upper limit signal (FLS)	A1	B1	<ul style="list-style-type: none"> Inputs from the limits switch at the stroke upper limit position. Positioning stops when this signal is turned OFF. This is the upper limit that searches for near-point dog signals when the OPR retry function is enabled.
Lower limit signal (RLS)	A2	B2	<ul style="list-style-type: none"> Inputs from the limits switch at the stroke lower limit position. Positioning stops when the lower limit signal is turned OFF. This is the lower limit that searches for near-point dog signals when the OPR retry function is enabled.
Near-point dog signal (DOG)	A3	B3	<ul style="list-style-type: none"> Used to detect near-point dog during mechanical OPR. Detects near-point dog signals using OFF→ON.
Stop signal (STOP)	A4	B4	<ul style="list-style-type: none"> Inputs when positioning is canceled. The positioning module cancels positioning when this signal is turned ON. Subsequently, the device does not move even if this signal is turned from ON to OFF.
External command signal (CHG)	A5	B5	<ul style="list-style-type: none"> Inputs control switching signals using speed-position switching control and position-speed switching control. Used as input signals for external positioning start, speed change requests, and skip requests. Use "[Pr.42] External command function selection" to set which functions can use this signal.
Common (COM)	A6	B6	Common for upper/lower limit signals, near-point dog signals, stop signals, and external command signals.
	A7	B7	
Drive unit READY signal (READY)	A11	B11	<ul style="list-style-type: none"> Turns ON when the feed pulse can be received at the drive unit is normal. The positioning module checks the drive module READY signal, and if the status is not ready, outputs an OPR request. This signal turns OFF when the drive module operations status is defective, such as if an error has been output to the drive module control power supply. Stops if this signal is turned OFF during positioning. Does not start even if the signal is turned ON again. The OPR complete signal also turns OFF if this signal is turned OFF.
Drive unit READY common (RDYCOM)	A12	B12	<ul style="list-style-type: none"> The drive unit READY common.
Deviation counter clear signal (CLEAR)	A13	B13	<p>Output during machine OPR. (Not output, however, if using count method 2.) (E.g. If using machine OPR with stopper stop method 2.)</p> <p> <ul style="list-style-type: none"> Set the deviation counter clear output time using "[Pr.55] Deviation counter clear signal output time". When the positioning module turns ON this signal, the drive module can reset the stop pulse amount of the internal deviation counter. </p> <p>Note: Deviation counter clear is the signal output by the positioning module during mechanical OPR. The user cannot specify the outputs.</p>
Deviation counter clear common (CLRCOM)	A14	B14	The deviation counter clear common.

Internal I/O interface circuits

A simplified diagram of the internal interface circuits for connecting a 1-axis external device to the positioning module is shown below.

Inputs

○: Wiring required during positioning, △: Wire as necessary

External wiring and internal circuits	Pin No.	Signal name	Wiring requirements	
	A3	Near-point dog signal (DOG)	△	
	A1	Upper limit signal (FLS)	○	
	A2	Lower limit signal (RLS)	○	
	A4	Stop signal (STOP)	△	
	A5	External command signal (CHG)	△	
	A6	Common (COM)		○
	A7			
	(+) A19	Manual pulse generator phase A (PULSER A+)	△	
	(-) B19	Manual pulse generator common A (PULSER A-)		
	(+) A20	Manual pulse generator phase B (PULSER B+)	△	
	(-) B20	Manual pulse generator common B (PULSER B-)		
	A11	Drive unit READY signal (READY)	○	
	A12	Drive unit READY common (RDY COM)	○	
	A8	Zero signal (+24 V) (PG024)	△	
	A9	Zero signal (+5 V) (PG05)		
	A10	Zero signal common (PG0COM)		

*1 The wiring if not using an upper limit switch is shown.
 *2 The wiring if not using a lower limit switch is shown.
 *3 Both +/- connections to the common (COM) are possible.

■Input signals ON/OFF status

The input signals ON/OFF status is determined by the external wiring and logic settings.

For example, near-point dog signals (DOG) (Other input signal operations are the same as for near-point dog signals (DOG).)

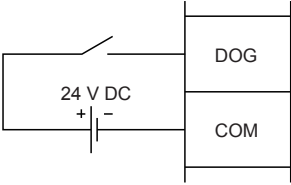
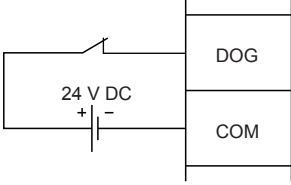
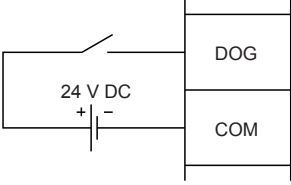
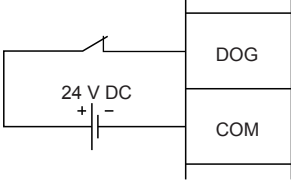
Logic settings ^{*1*2}	External wiring ^{*2}	Positioning module ON/OFF status
Negative logic (default value)	■When no voltage is applied 	OFF
	■When voltage is applied 	ON
Positive logic	■When no voltage is applied 	ON
	■When voltage is applied 	OFF

*1 Make the logic settings using "[Pr.22] Input signal logic selection". For details on the settings, refer to the following.

☞ Page 402 [Pr.22] Input signal logic selection

*2 If using upper limit signals (FLS) and lower limit signals (RLS), make sure to wire as contact b using the negative logic settings. Positioning stops when this signal is turned OFF.

■Logic settings and internal circuits

The positioning module is defined as "input signals OFF" if the internal circuits (photocoupler) are turned OFF using the negative logic settings.

Conversely, the positioning module is defined as "input signals ON" if the internal circuits (photocoupler) are turned OFF using the positive logic settings.

The photocoupler ON/OFF status is described below.

- When no voltage is applied: Photocoupler OFF
- When voltage is applied: Photocoupler ON

Outputs (FX5-20PG-P)

○: Wiring required during positioning, △: Wire as necessary

External wiring and internal circuits	Pin No.	Signal name	Wiring requirements	
	A13	Deviation counter clear signal (CLEAR)	△	
	A14	Deviation counter clear common (CLEAR COM)		
	A15	CW Phase A PULSE	Pulse outputs F (PULSE F)	○
	A16		Pulse outputs F common (PULSE COM)	
	A17	CCW Phase B SIGN	Pulse outputs R (PULSE R)	
	A18		Pulse outputs R common (PULSE COM)	

Outputs (FX5-20PG-D)

○: Wiring required during positioning, △: Wire as necessary

External wiring and internal circuits	Pin No.	Signal name	Wiring requirements	
	A13	Deviation counter clear signal (CLEAR)	△	
	A14	Deviation counter clear common (CLEAR COM)		
	A15	CW Phase A PULSE	Pulse output F (+) (PULSE F+)	○
	A16		Pulse output F (-) (PULSE F-)	
	A17	CCW Phase B SIGN	Pulse output R (+) (PULSE R+)	
	A18		Pulse output R (-) (PULSE R-)	
	*1	Differential driver common terminal	PLS COM	△

*1 For connect, refer to Page 50 Differential Driver Common Terminal.

7 STARTING AND STOPPING



This chapter describes how to start and stop positioning control operations with the positioning module.

7.1 Starting

The positioning module starts the positioning control when a start trigger, specific to the control, is turned on. The following table lists the start signals by control type. This section describes starting with the "[Cd.184] Positioning start signal" and external command signals.

Control details		Start trigger
Major positioning control		<ul style="list-style-type: none"> • Turn ON the "[Cd.184] Positioning start signal". • Implement GP.PSTRT. • Turn ON external command signals (CHG).
Advanced positioning control		
OPR control		
Manual control	JOG operation	Turn ON either "[Cd.181] Forward JOG start signal" or "[Cd.182] Reverse JOG start signal".
	Inching operation	
	Manual pulse generator operation	Manipulate a manual pulse generator.

For the controls other than the manual controls, any one of the following start modes can be selected.

- Normal start ( Page 65 Normal start)
- Quick start ( Page 66 Quick start)
- Multiple axes simultaneous start ( Page 71 Multiple axes simultaneous start)

The target position for a control can be specified using positioning data, Block start data, and condition data. Available data depends on the selected start mode.

Start condition

Satisfy the following conditions to start a program. In addition, set the required conditions in the program to prevent an operation from starting if the conditions are not satisfied.

Signal name		Signal status		Device
I/O signals	PLC READY signal	ON	The CPU module is ready.	[Cd.190] PLC READY signal
	READY signal	ON	Positioning module READY	[Md.140] Module status.b0
	Module access flag ^{*1}	ON	The positioning module buffer memory can be accessed	[Md.140] Module status.b1
	Axis stop signal	OFF	Axis stop signal is OFF	[Cd.180] Axis stop signal
	M code ON signal	OFF	M code ON signal is off.	[Md.31] Status.b12
	Error detection signal	OFF	No error has been detected.	[Md.31] Status.b13
	BUSY signal	OFF	BUSY signal is off.	[Md.141] BUSY signal
	Start complete signal	OFF	Start complete signal is off.	[Md.31] Status.b14
External signal	Drive unit READY signal (READY)	ON	The drive unit is ready.	—
	Stop signal (STOP)	OFF	Stop signal is off.	—
	Upper limit signal (FLS)	ON	The current position is within the limit.	—
	Lower limit signal (RLS)	ON	The current position is within the limit.	—

*1 The interlock must be provided so that the buffer memory is accessed after the module access flag ([Md.140] Unit status: b1) turns ON. When no interlock is provided, the buffer memory may be accessed while the module parameter and module extension parameter that are sent from the CPU module are updated. If the buffer memory is accessed during the update, an unexpected value may be read or written.

Start with "[Cd.184] Positioning start signal"

This section describes operations started with "[Cd.184] Positioning start signal".

- When the "[Cd.184] Positioning start signal" is turned ON, the start complete signal ([Md.31] Status: b14) and "[Md.141] BUSY signal" turn ON, and positioning operations start. The on state of the "[Md.141] BUSY signal" indicates that the corresponding axis is in operation.
- When the "[Cd.184] Positioning start signal" is turned OFF, the start complete signal ([Md.31] Status: b14) turns OFF. If the "[Cd.184] Positioning start signal" remains ON even after the positioning is completed, the start complete signal ([Md.31] Status: b14) also remains ON.
- If the positioning start signal is turned ON again while the "[Md.141] BUSY signal" is ON, Start during operation (Warning code: 0900H) occurs.
- The operation performed after the completion of the positioning operation depends on whether or not the next positioning control is set.

Presence or absence of the next positioning control	Processing
When the next positioning control is performed	<ul style="list-style-type: none"> • If [Da.9] Dwell time is set, the positioning module waits for the set time to elapse, and the positioning will be completed. • When positioning is finished, the "[Md.141] BUSY signal" turns OFF, and the start complete signal ([Md.31] Status: b14) turns ON. However, when the speed control has been used or the ON time of Positioning complete signal is 0, Positioning complete signal [X14, X15, X16, X17] does not turn on. • When the time set in "[Pr.40] Positioning complete output signal time" elapses, the positioning complete signal ([Md.31] Status: b15) turns OFF.
When the next positioning control is not performed	<ul style="list-style-type: none"> • If [Da.9] Dwell time is set, the positioning module waits for the set time to elapse. • When the time set in [Da.9] Dwell time elapses, the next positioning control starts.

7

Time chart for starting

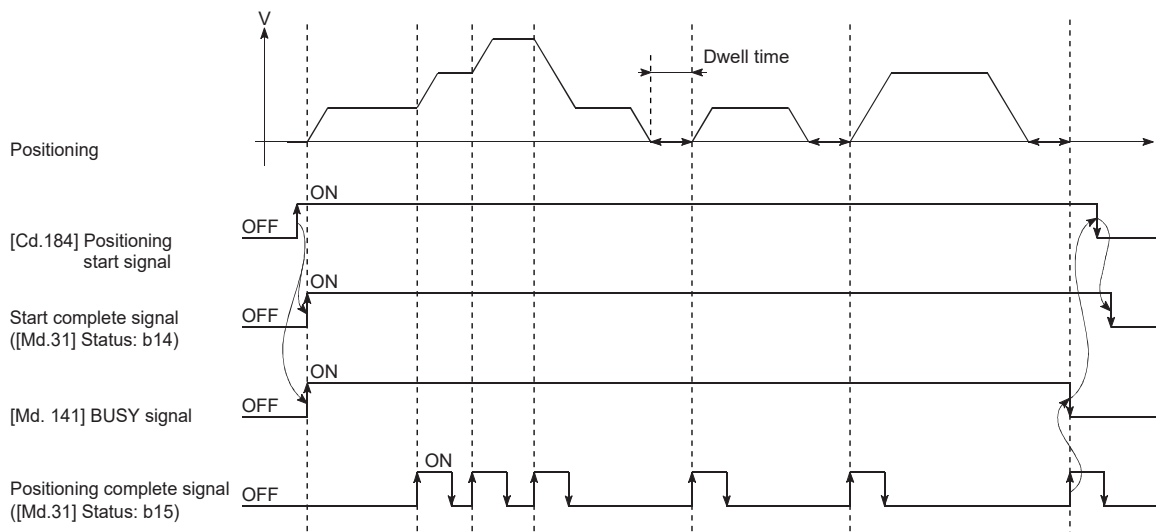

Point

The "[Md.141] BUSY signal" turns ON even when the position control of a movement amount 0 is implemented. However, as the ON time is short, the ON status may not be detected by the program. (Start complete signal ([Md.31] Status: b14), Positioning complete signal ([Md.31] Status: b15), and M code ON signal ([Md.31] Status: b12) can detect the ON status using the program.)

Starting using external command signals (CHG)

When the positioning control is started by inputting an external command signal (CHG), the start command can be directly input to the positioning module. This method eliminates the variation time equivalent to one scan time of the CPU module. Use the start command when an operation is required to be started as soon as possible, or when the starting variation time is to be suppressed.

Starting method

To start the positioning with the external command signal, set [Pr.42] External command function selection beforehand, and validate [Cd.8] External command valid using a program. After setting those two areas, turn ON external command signals (CHG).

Setting item		Setting value	Setting details	Buffer memory address	
				Axis 1	Axis 2
[Pr.42]	External command function selection	0	Sets "0: Start with external command".	62	212
[Cd.8]	External command valid	1	Set" 1: Validate external command".	1505	1605

Restrictions

When starting by inputting an external command signal (CHG), the start complete signal ([Md.31] Status: b14) does not turn ON.

Time chart for starting

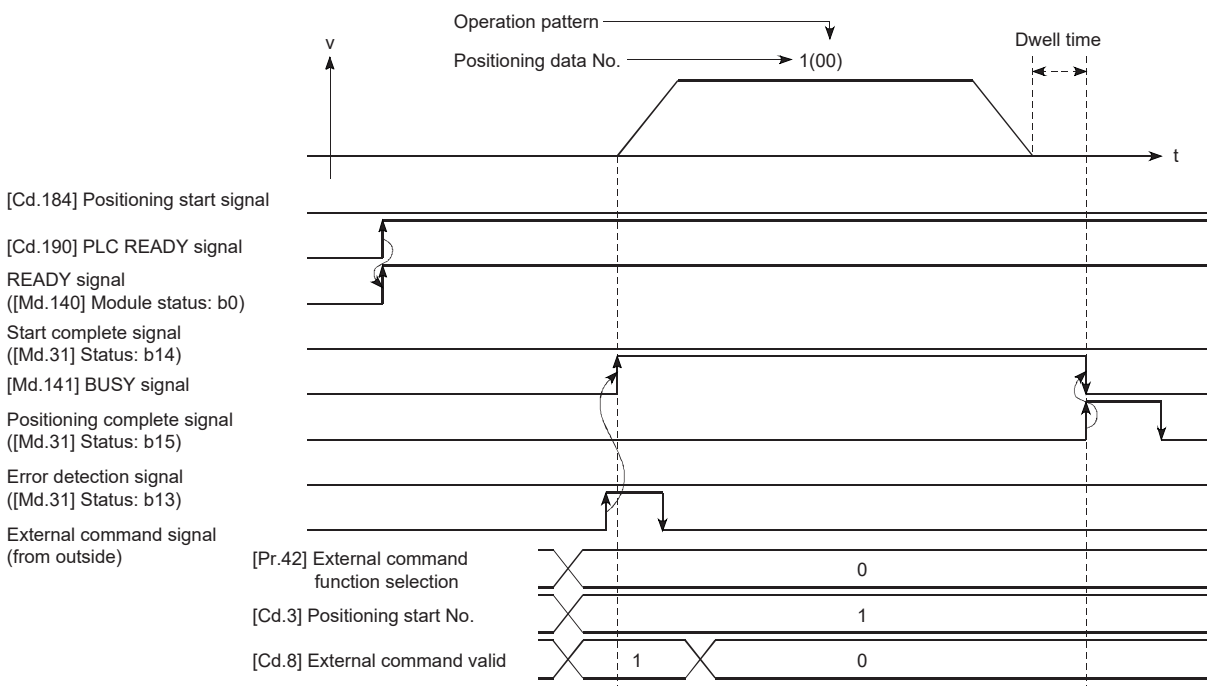

Normal start

Positioning controls can be started by the simplest procedure in this mode. Major positioning controls and advanced positioning controls can be started in this mode.

The following positioning data is used.

- Positioning data (No. 1 to No. 600)
- Block start data (No. 7000 to No. 7004)
- Machine OPR (No. 9001)
- Fast OPR (No. 9002)
- Current value change (No. 9003)

Starting method

After setting positioning data, input a start trigger to start the specified positioning data. The following table lists the start triggers used in this mode.

Start trigger name	Starting method (Start trigger)	Positioning data to be started
Positioning start signal	Turning OFF→ON the "[Cd.184] Positioning start signal"	Starts the positioning data specified in [Cd.3] Positioning start No.
External command signal	Turning OFF→ON external command signals (CHG)	Starts the positioning data specified in [Cd.3] Positioning start No.
Dedicated instruction	Executing the GP.PSTRT□instruction	Starts the positioning data specified as the control data.

Program example

This section shows program examples of the normal start for each command trigger.

■For module FB

For the program example using the module FB, refer to the following.

☞ Page 503 Positioning start program

■If using the "[Cd.184] Positioning start signal"

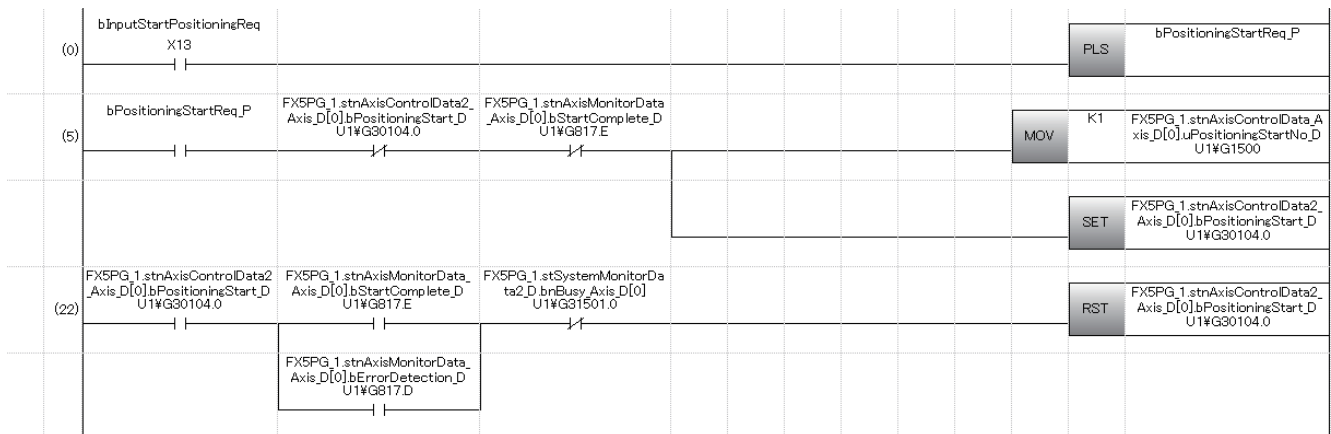

Classification	Label Name	Buffer memory address	Description	
Module label	FX5PG_1.stnAxisMonitorData_Axis_D[0].uStatus_D.D	817.b13	Axis 1 Error detection signal	
	FX5PG_1.stSystemMonitorData2_D.bnBusy_Axis_D[0]	31501.b0	Axis 1 BUSY signal	
	FX5PG_1.stnAxisMonitorData_Axis_D[0].uStatus_D.E	817.b14	Axis 1 Start complete signal	
	FX5PG_1.stnAxisControlData2_Axis_D[0].bPositioningStart_D	30104.b0	Axis 1 Positioning start signal	
	FX5PG_1.stnAxisControlData_Axis_D[0].uPositioningStartNo_D	1500	Axis 1 Positioning start No.	
Global label, local label	Define the global label or local label as follows. Setting Assign (Device/Label) for labels is not necessary because the unused internal relay and data device are automatically assigned to the labels.			
	Label Name	Data Type	Class	
1	bPositioningStartReq_P	Bit	VAR	
	Label Name	Data Type	Class	Assign (Device/Label)
1 2	bInputStartPositioningReq	Bit	VAR_GLOBAL	X1 3

■If using external command signals (CHG)

Positioning can be started by setting "0: Start with external command" in "[Pr.42] External command function selection" and inputting external command signals (CHG) after implementing the following program.

☞ Page 501 External command function valid setting program

Quick start

Positioning controls can be started quickly by analyzing in advance the positioning data executed immediately after the current operation to prevent the analysis time affecting the start. Positioning data for the major positioning controls can be started in this mode.



By using an external command signal as a start trigger, positioning controls can be started bypassing the program, which means that the operation is quickly started without being affected by the execution time of the program.

Starting method

After setting positioning data, set "[Cd.43] Analysis mode setting" to "1: Pre-analysis mode" and input a start trigger signal while "[Md.61] Analysis complete flag" is "1: Analysis completed". The following table shows the quick start triggers used in this mode.

Start trigger name	Starting method (Start trigger)	Positioning data to be started
Positioning start signal	Turning OFF→ON the "[Cd.184] Positioning start signal"	Starts the positioning data specified in [Cd.3] Positioning start No.
External command signal	Turning OFF→ON external command signals (CHG)	Starts the positioning data specified in [Cd.3] Positioning start No.

Depending on the start timing of the positioning data analysis, a start trigger used is determined. Even if the settings are changed after the start of the positioning data analysis, the changed settings are not valid. Consequently, when the following settings are configured, external command signals (CHG) are used as a start trigger.

- Set "[Pr.42] External command function selection" to "0: Start with external command"
- Set "[Cd.8] Enable command valid" to "1: Validate external command"

If not set as described above, the "[Cd.184] Positioning start signal" can be used as a start trigger.

Control details

Length of time before the positioning starts

While "[Cd.43] Analysis mode settings" is set to "1: Pre-analysis mode", the positioning data specified in "[Cd.3] Positioning start No." is analyzed. The following shows the start timing of positioning data analysis.

- While transitioning to pre-analysis mode (Timing when the setting of "[Cd.43] Analysis mode settings" is changed to "1: Pre-analysis mode")
- When the positioning start No. is changed after the analysis of the positioning data has been completed (Timing when the setting of "[Cd.3] Positioning start No." is changed while "[Md.61] Analysis complete flag" is "1: Analysis completed")
- When the positioning operation is completed and "[Md.26] Axis operation status" turns to "0: Standby". If the M code ON signal ([Md.31] Status: b12) is ON, however, positioning analysis will not start until the M code ON signal ([Md.31] Status: b12) turns OFF.

Once the analysis of the positioning data is completed, "[Md.61] Analysis complete flag" turns to "1: Analysis completed". The quick start is executed by inputting a start trigger while the "[Md.61] Analysis complete" flag is set to "1: Analysis completed". After the quick start is implemented, the "[Md.61] Analysis complete flag" turns to "0: Analysis not completed".

The pre-analysis mode is changed to the normal analysis mode not only by setting "[Cd.43] Analysis mode" setting to "0: Normal analysis mode", but also by the following factors. When the setting of "[Cd.43] Analysis mode setting" is changed to "0: Normal analysis mode", the positioning data that has already been analyzed is cleared. (During interpolation control, the positioning data is cleared when the reference axis enters normal analysis mode)

- When an error is detected
- When the "[Cd.190] PLC READY signal" is turned ON→OFF
- When the positioning operation is stopped by a stop signal

If any of the three causes described above occurs, the reference axis or interpolation axis enters the normal analysis mode in the interpolation control.

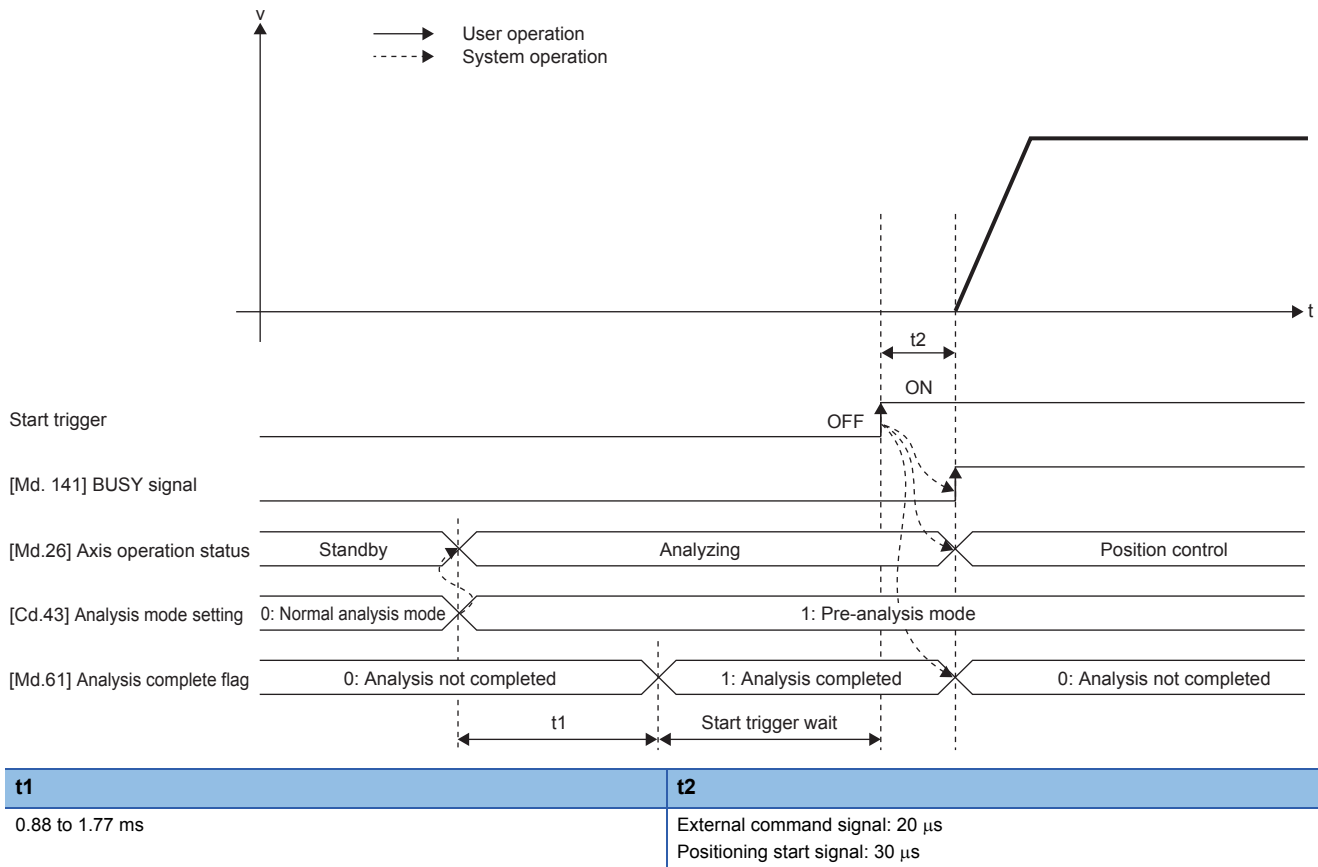

The shortest time between the completion of the positioning control and the starting of the next positioning control is $t1 + t2$.

■Executing the quick start repeatedly

The quick start can be executed repeatedly by keeping [Cd.43] Analysis mode setting set to 1: Pre-analysis mode.

When [Cd.3] Positioning start No. is set to the positioning data No. used for the positioning control 2 during the operation of the positioning control 1, the operation is performed as follows.

- The positioning by the positioning control 1 is completed and [Md.26] Axis operation status turns to 0: Standby.
- When [Md.26] Axis operation status turns to 0: Standby, the positioning data specified in [Cd.3] Positioning start No. starts to be analyzed.

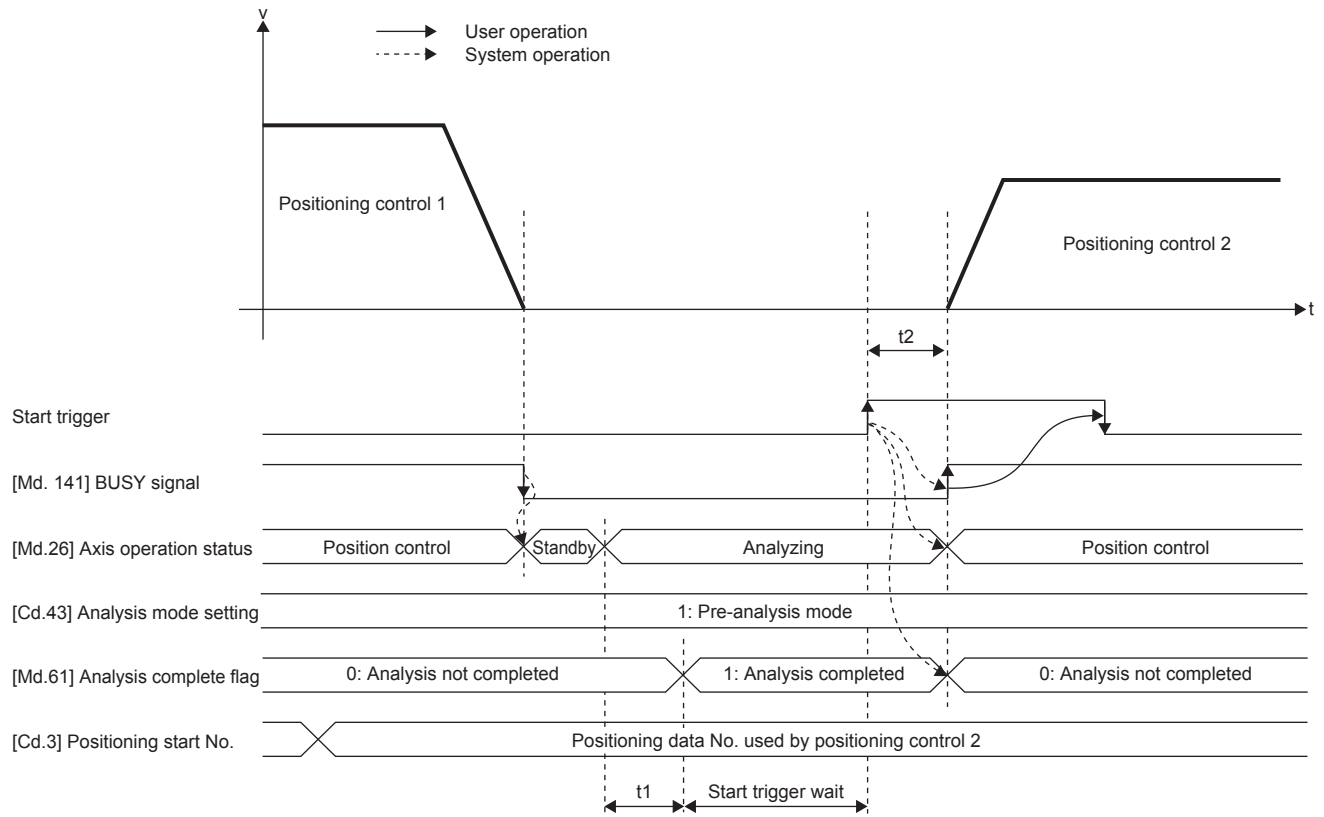

■Reanalysis of positioning data

The setting of [Cd.3] Positioning start No. is changed while [Md.61] Analysis complete flag is 1: Analysis completed, [Md.61] Analysis complete flag turns to 0: Analysis not completed and the positioning data will be reanalyzed. When the reanalysis is completed, [Md.61] Analysis complete flag turns again to 1: Analysis completed.

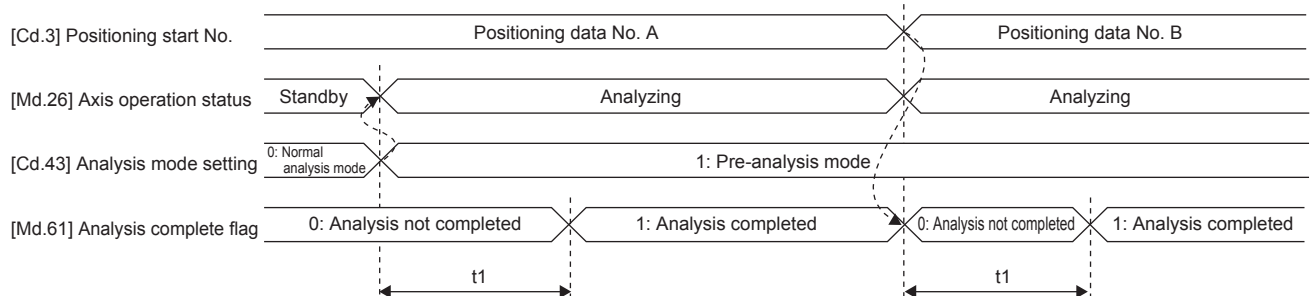

Restrictions

- The range of the positioning data No. used for the quick start is between 1 and 600. If a number other than 1 to 600 is set for [Cd.3] Positioning start No., Pre-analysis not possible (Warning code: 09A8H) occurs and the pre-analysis of positioning data is not performed. However, by inputting a start trigger signal, positioning data is analyzed before the positioning is started, just as in the normal analysis mode. In this case, the setting in [Cd.43] Analysis mode setting remains 1: Pre-analysis mode.
- In the pre-analysis mode, restarting is not allowed. To allow restarting, turn on a stop signal and change the analysis mode to the normal analysis mode. If the analysis mode is changed again to the pre-analysis mode after changed to the pre-analysis mode and restarting is attempted, Restart not possible (Error code: 090BH) occurs and restarting cannot be executed.
- In the pre-analysis mode, the step function cannot be used. Even if [Cd.35] Step valid flag is 1: Carry out step operation while positioning data is being analyzed, Step start disabled (Warning code: 09A6H) occurs and the normal operation is performed with the setting ignored. (The step operation does not stop.)
- In the pre-analysis mode, the pre-reading start function cannot be used. "[Cd.183] Execution prohibition flag" is ignored.
- In the pre-analysis mode, the manual control cannot be used. Starting the manual control causes Manual control start in pre-analysis mode (Warning code: 09A4H), and the manual control does not start.
- While other axes are in pre-analysis mode, do not implement manual pulse generator operations. The axis implementing manual pulse generator operations may output pulses using unintended timing.
- The machine OPR, the fast OPR, the speed switching control using the positioning control (block start) and External command signal, the position-speed switching control, the speed change, and the skip command cannot be used because External command signal is invalid for a maximum of 1.77 ms after the start. However, the speed-position switching control, the position-speed switching control, and the speed change with the buffer memory can be performed.

Precautions

- If a start trigger is input while [Md.61] Analysis complete flag is 0: Analysis not completed, Pre-analysis incomplete start (Warning code: 09A2H) occurs and the positioning will be started after the analysis of the positioning data is completed.
- When [Md.61] Analysis complete flag is set to 1: Analysis completed, errors are detected at intervals of 0.88 ms. Thus, if a start trigger is input within 0.88 ms after the occurrence of an error, the operation may be started. In this case, the error is detected immediately after the start, and the operation stops.
- The data reflected to basic parameter 2, detailed parameter 2, and positioning data is the one in the buffer memory at the start of the analysis of positioning data. Therefore, even if a set value of basic parameter 2 and other data is changed after the analysis of positioning data has been completed (When [Md.61] Analysis complete flag is 1: Analysis completed), the value is not reflected to the control. To reflect the set value, conduct a reanalysis by changing the setting of [Cd.3] Positioning start No. or using other methods.

Point

The analysis of positioning data is performed by checking the settings of [Cd.43] Analysis mode setting and [Cd.3] Positioning start No. at intervals of 0.88 ms. Thus, set [Cd.43] Analysis mode setting and [Cd.3] Positioning start No. beforehand so that the analysis starts 0.88 ms earlier than the desired start timing and earlier than a length of time longer than the analysis time for the positioning data. The analysis time for the positioning data is approximately equal to the start time.

- For all the axes to which the quick start is performed, set [Cd.43] Analysis mode setting to 1: Pre-analysis mode. If 1: Pre-analysis mode is set for the reference axis and 0: Normal analysis mode is set for the interpolation axes, Pre-analysis not possible (Warning code: 09A9H) occurs and the pre-analysis of positioning data is not performed. However, by inputting a start trigger signal, positioning data is analyzed before the positioning is started, just as in the normal analysis mode. In this case, the setting in [Cd.43] Analysis mode setting remains 1: Pre-analysis mode.
- In the pre-analysis mode, the analysis of positioning data is performed in ascending order of axis numbers. For axes that do not require the analysis of positioning data, such as an axis to be interpolated, setting [Cd.3] Positioning start No. to 0 is recommended. Because the analysis of positioning data is not performed for the axes for which 0 is set, the time that elapses until the positioning start is cut off.

- During pre-analysis mode, do not turn OFF→ON "[Cd.184] Positioning start signal" when "[Pr.42] External command function selection" is set to "0: Start with external command" and "[Cd.8] External command valid" is set to "1: Validate external command". Positioning start signal input at quick external start (Warning code: 09A7H) occurs and no operation is started.
- When [Pr.42] External command function selection is set to a value other than 0: Start with external command in the pre-analysis mode, an external command signal is disabled for 1.77 ms maximum after start starting. Input an external command signal 1.77 ms or longer after starting.

■Precautions for the processing performed at the pre-analysis of positioning data

The following table lists the processing performed at the pre-analysis of positioning data.

Major positioning control		Processing performed at the pre-analysis of positioning data
Position control	1-axis linear control	<ul style="list-style-type: none"> • Clearing the axis control data • Initializing the axis monitor data • Positioning complete signal ([Md.31] Status: b15) OFF
	2-axis linear interpolation control	
	1-axis fixed-feed control 2-axis fixed-feed control	<ul style="list-style-type: none"> • Clearing the axis control data • Initializing the axis monitor data • Positioning complete signal ([Md.31] Status: b15) OFF • Clearing the current feed value to 0 • Clearing the values after the decimal point held in the positioning module
	2-axis circular interpolation control	<ul style="list-style-type: none"> • Clearing the axis control data • Initializing the axis monitor data • Positioning complete signal ([Md.31] Status: b15) OFF
1-axis speed control 2-axis speed control	<ul style="list-style-type: none"> • Clearing the axis control data • Initializing the axis monitor data • Positioning complete signal ([Md.31] Status: b15) OFF <p>When [Pr.21] Current feed value during speed control is 2: Current feed value is cleared to zero, the following processing is also performed.</p> <ul style="list-style-type: none"> • Clearing the current feed value to 0 • Clearing the values after the decimal point held in the positioning module 	
Speed-position switching control	<ul style="list-style-type: none"> • Clearing the axis control data • Initializing the axis monitor data • Positioning complete signal ([Md.31] Status: b15) OFF <p>When [Pr.21] Current feed value during speed control is 2: Current feed value is cleared to zero, the following processing is also performed.</p> <ul style="list-style-type: none"> • Clearing the current feed value to 0 • Clearing the values after the decimal point held in the positioning module 	
Position-speed switching control		
Current value change	<ul style="list-style-type: none"> • Clearing the axis control data • Initializing the axis monitor data • Positioning complete signal ([Md.31] Status: b15) OFF • Clearing the current feed value to 0 • Clearing the values after the decimal point held in the positioning module 	

Note that if [Cd.43] Analysis mode setting is set to 1: Pre-analysis mode and is held, the analysis of the next positioning data will start immediately after the current positioning operation is completed.

For example, Positioning complete signal ([Md.31] Status: b15) turns on at the completion of positioning and immediately turns OFF when the pre-analysis is started at the completion of positioning. Consequently, depending on the scan time, the ON state of the signal may not be detected by the program used. If necessary, set 0 in [Cd.3] Positioning start No. after the positioning starts to avoid the analysis of the next positioning data.

Program example

For the program example of the quick start, refer to the following.

☞ Page 503 Quick start program

Multiple axes simultaneous start

In this starting mode, the simultaneous starting axis and the started axis start outputting pulses at the same timing.

Control details

Perform the multiple axes simultaneous start by setting the following buffer memory areas and turning on a start trigger.

- Set a start data No. for each simultaneous starting axis (positioning data No. for each axis started simultaneously) in "[Cd.30] and [Cd.31] Simultaneous starting axis start data No. (Axes 1 and 2 start data No.)".
- Set 9004 to [Cd.3] Positioning start No. for the starting axis.

Ex.

The following figure shows the control when the multiple axes simultaneous start control is implemented with the axis 1 (starting axis) and axis 2.

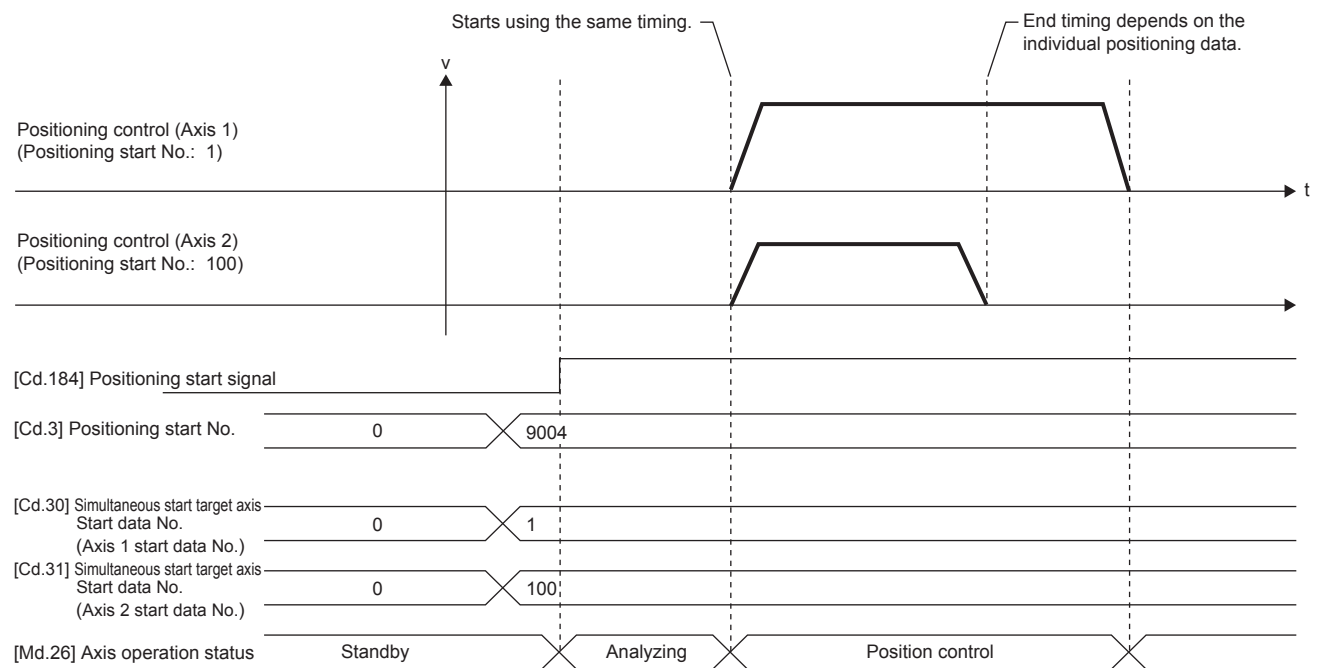

Restrictions

- If "[Cd.30] and [Cd.31] Simultaneous starting axis start data No." of the started axis are not set, or the set values are outside the setting range, Error before simultaneous start (Error code: 1991H) occurs and all the simultaneous starting axes will not start.
- If the simultaneous starting axis is in the axis BUSY state, Error before simultaneous start (Error code: 1990H) occurs and the simultaneous starting axis will not start.
- If an error occurs during the analysis of the positioning data on the simultaneous starting axes, Simultaneous start not possible (Error code: 199EH) occurs and all the simultaneous starting axes will not start.
- If the simultaneous starting axis is the started axis only, no error or warning occurs.

Procedure

The following figure shows the procedure for the multiple axes simultaneous start control.

1. Set "[Cd.30] and [Cd.31] Simultaneous starting axis start data No."
2. Write [9004] to "[Cd.3] Positioning start No."
3. Turn ON the positioning start signal to start

Setting method

The following table lists the data settings to perform the multiple axes simultaneous start using Positioning start signal. (Set the axis control data for the starting axis.)

Setting item		Setting value	Setting details	Buffer memory address	
				Axis 1	Axis 2
[Cd.3]	Positioning start No.	9004	Set 9004, the start No. for the multiple axes simultaneous start control.	1500	1600
[Cd.30]	Simultaneous starting axis start data No. (Axis 1 start data No.)	0 to 600	Set the simultaneous starting axis start data No. Set 0 for the axis other than the simultaneous starting axis.	1540	1640
[Cd.31]	Simultaneous starting axis start data No. (Axis 2 start data No.)			1541	1641

For details on the settings, refer to the following.

☞ Page 470 [Cd.3] Positioning start No.

☞ Page 479 [Cd.30] Simultaneous starting axis start data No. (Axis 1 start data No.)

☞ Page 479 [Cd.31] Simultaneous starting axis start data No. (Axis 2 start data No.)

Setting example

The following table shows the setting example in which the axis 1 is used as the starting axis and axis 2 is used as the simultaneous starting axis.

Setting item		Setting value	Setting details	Buffer memory address
				Axis 1
[Cd.3]	Positioning start No.	9004	Set 9004, the start No. for the multiple axes simultaneous start control.	1500
[Cd.30]	Simultaneous starting axis start data No. (Axis 1 start data No.)	100	Axis 1 starts the positioning data No.100.	1540
[Cd.31]	Simultaneous starting axis start data No. (Axis 2 start data No.)	200	Immediately after the start of the axis 1, the axis 2 starts the axis 2 positioning data No.200.	1541

Point

- The multiple axes simultaneous start control performs an operation equivalent to the simultaneous start using the block start data.
- The setting of the multiple axes simultaneous start control is easier than that of the simultaneous start using the block start data. For the simultaneous start using the block start data, positioning start data, positioning data, block start data, and condition data are required to be set. On the other hand, the multiple axes simultaneous start control can be used only by setting positioning data and axis control data.
- The execution time of the positioning depends on the settings of each axis. Thus, the positioning of each axis is not completed simultaneously.

7.2 Stopping

This section describes the stop control of the positioning. The following events may stop each positioning control by the positioning module.

- When each control ends normally
- When Drive unit READY signal (READY) is turned OFF
- When an error occurred in the CPU module
- When "[Cd.190] PLC READY signal" is turned OFF
- If an error occurred in the positioning module
- When an operation is intentionally stopped (When a stop signal sent from the CPU module is turned ON, or a stop signal from an external device)

Stop processing

The stop controls are classified into three types: deceleration stop, sudden stop, and immediate stop. The following table describes the stop controls (deceleration stop, sudden stop, and immediate stop) at the occurrence of each stop cause (When the automatic deceleration control is performed).

Stop cause		Stop axis	Buffer memory status after stopping		Stop processing	
			M code ON ([Md.31]: b12)	[Md.26] Axis operation status	Main functions other than manual pulse generator operations	Manual pulse generator operation
Forced stop	Drive unit READY signal (READY) is OFF	Each axis	Not changed	Error	Immediate stop	Deceleration stop
Fatal stop (Stop group 1)	Hardware stroke limit upper/lower limit error occurred	Each axis	Not changed	Error	Deceleration stop or sudden stop (Select with [Pr.37] Stop group 1 sudden stop selection.)	Deceleration stop
Emergency stop (Stop group 2)	CPU module error occurred	All axes	Not changed	Error	Deceleration stop or sudden stop (Select with [Pr.38] Stop group 2 sudden stop selection.)	Deceleration stop
	"[Cd.190] PLC READY signal" OFF		Turned OFF			
	Failure in the test mode		Not changed			
Relatively safe stop (Stop group 3)	Axis error detection (errors other than the ones in stop group 1 and 2) ^{*1}	Each axis	Not changed	Error	Deceleration stop or sudden stop (Select with [Pr.39] Stop group 3 sudden stop selection.)	Deceleration stop
	Error at operation mode switching in amplifier-less operation ^{*2}	All axes				
Intentional stop (Stop group 3)	Stop signal turned ON by an external device	Each axis	Not changed	Stopped (standby)		
	Axis stop signal ([Cd.180]) from the CPU module is turned ON.					
	"Stop" input from GX Works3					

*1 When multiple positioning data is implemented by the continuous positioning control or continuous path control and there is an invalid setting value in a positioning data, an error occurs and deceleration to stop is implemented at the previous positioning data. In this case, the sudden stop is not performed even if sudden stop is selected for the stop group 3. If any of the following errors occurs, the operation is immediately stopped after the execution of the positioning data that is one before the positioning data No. where the error occurred.

- No command speed (Error code: 1A13H, 1A14H)
- Outside linear movement amount range (Error code: 1A15H, 1A16H)
- Large arc error deviation (Error code: 1A17H)
- Software stroke limit (+) (Error code: 1A18H, 1A19H)
- Software stroke limit (-) (Error code: 1A1AH, 1A1BH)
- Sub point setting error (Error code: 1A27H, 1A28H, 1A29H, 1A2AH, 1A37H)
- End point setting error (Error code: 1A2BH, 1A2CH)
- Center point setting error (Error code: 1A2DH, 1A2EH, 1A2FH)
- Outside radius range (Error code: 1A32H)
- Illegal setting of ABS direction in unit of degree (Error code: 19A4H, 19A5H)

*2 Describes errors (error code: 18B0H) when switching operations modes from normal operation mode→amplifier-less operations mode and errors (error code: 18B1H) when switching from amplifier-less operation mode →normal operation mode.

Classification of the stop processing types

The stop processing during the operation is classified into three types: deceleration stop, sudden stop, and immediate stop.

■Deceleration stop

This processing is implemented using [Pr.10] Deceleration time 0, and [Pr.28] Deceleration time 1 to [Pr.30] Deceleration time 3. Select any time from Deceleration time 0 to Deceleration time 3 and set the time in [Da.4] Deceleration time No.

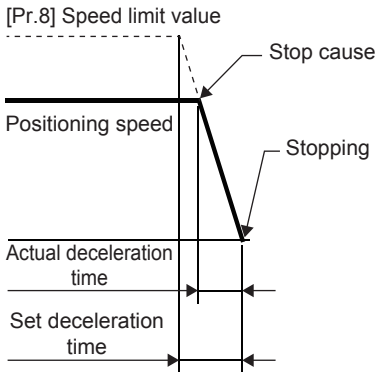

■Sudden stop

This processing is performed using [Pr.36] Sudden stop deceleration time.

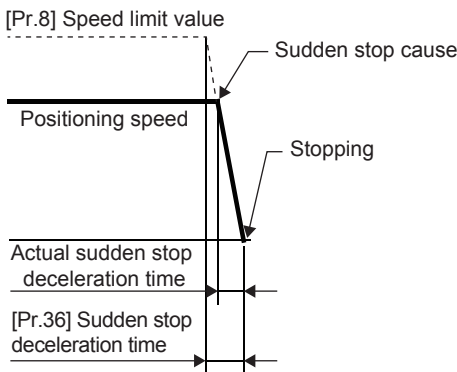

■Immediate stop

This processing does not include deceleration processing. The positioning module immediately stops outputting pulses but the target moves for the distance of droop pulses of the deviation counter of the drive unit.

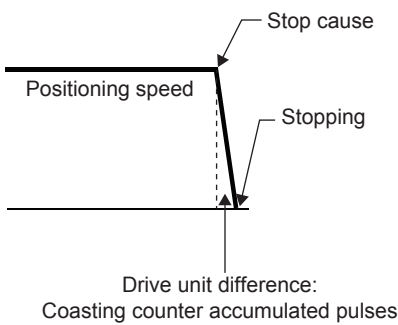

Point

Select either deceleration stop or sudden stop for [Pr.37] Stop group 1 sudden stop selection to [Pr.39] Stop group 3 sudden stop selection in detailed parameter 2. (The factory default setting is "Deceleration stop".)

Order of priority for the stop processing

The order of priority for the positioning module stop processing is as described below.

(Deceleration stop) < (Sudden stop) < (Immediate stop)

If the deceleration stop command is ON (i.e., the stop signal is ON) or a deceleration stop cause occurs during the deceleration to speed 0 (including automatic deceleration), the operation changes depending on the setting in [Cd.42] Stop command processing for deceleration stop selection. ([Page 276 Stop command processing for deceleration stop function](#))

Positioning control during the deceleration	Setting value of [Cd.42]	Processing
Manual control	—	Regardless of the setting of "[Cd.42] Stop command processing for deceleration stop selection", a deceleration curve is re-processed from the speed at the occurrence of a stop cause.
OPR control, positioning control	0: Recreate deceleration curve	Recreates the deceleration curve from the speed when the stop factors occurred. (Page 276 Deceleration curve re-processing)
	1: Continue deceleration curve	The current deceleration curve is maintained after the occurrence of a stop cause. (Page 276 Deceleration curve continuation)

If the on state of the stop signal or stop cause specified for a sudden stop occurs is detected during deceleration, the sudden stop processing will start at that point. However, if the sudden stop deceleration time is longer than the deceleration time, the deceleration stop processing will be continued even if a sudden stop cause occurs during the deceleration stop processing.

[E.g.] The processing if a sudden stop factor is input during deceleration to stop is described below.

- If deceleration stop time > Sudden stop deceleration time

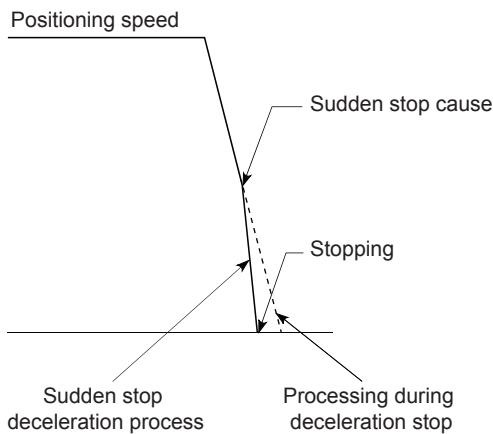

- If deceleration stop time < Sudden stop deceleration time

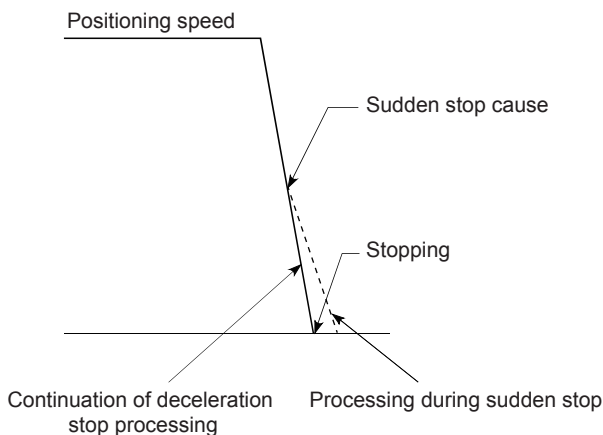

Further, in the position control (including the speed-position switching control and position-speed switching control), the positioning may stop depending on the timing of the stop cause occurrence and the set value in "[Pr.36] Sudden stop deceleration time".

- Sudden stop before the specified positioning address

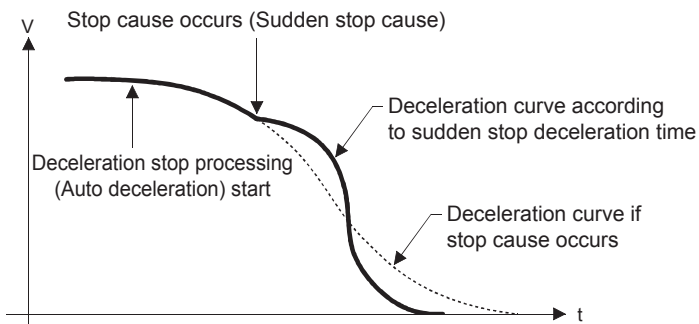

- Sudden stop upon reaching the specified positioning address

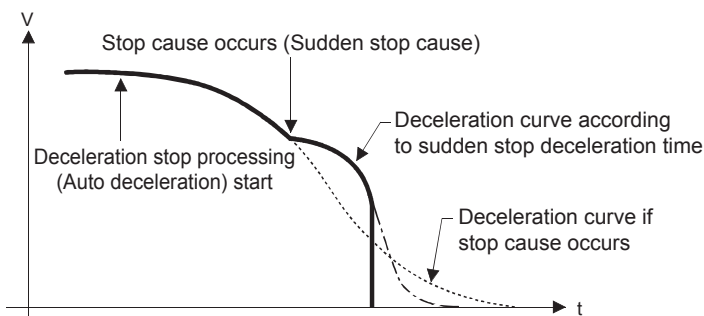

Stop signal input during deceleration

- Even if a stop signal is input during deceleration (including automatic deceleration), the positioning will stop with the current deceleration speed kept until it completely stops.
- When a stop signal is input during deceleration in the OPR control, the positioning will stop with the current deceleration speed kept until it completely stops. If the positioning operates at a creep speed, the positioning will immediately stop.
- If the stop cause specified for a sudden stop occurs during deceleration, the sudden stop processing will start at that point. The sudden stop processing during deceleration is performed only when the sudden stop time is shorter than the deceleration stop time.

7.3 Restarting

If the positioning control is stopped by a stop command ("[Cd.180] Axis stop signal" or a stop signal from an external device), the positioning can be restarted from the stopped position to the end point of the position control by using ("[Cd.6] Restart command"). (However, restarting is not possible when the continuous operation is interrupted.)

This command is useful when performing the remaining positioning from the stopped position during the position control of the incremental system such as the INC linear 1. (The remaining distance does not need to be calculated.)

Operation

After a deceleration stop by a stop command is completed, write 1 to [Cd.6] Restart command while [Md.26] Axis operation status is "1: Stopped". The positioning restarts.

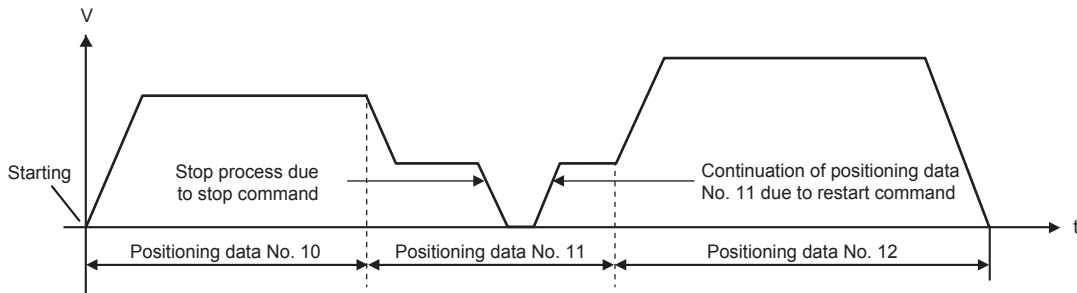

Restrictions

- Restarting can be implemented only when "[Md.26] Axis operation status" is "1: Stopped" (i.e., the deceleration stop using the stop command is completed). If "[Md.26] Axis operation status" is not "1: Stopped", restart not possible (Warning code: 0902H) occurs and restarting is not implemented. The processing at that time will be continued.
- Restarting can be executed even while Positioning start signal is ON. However, do not turn OFF→ON the positioning start signal while "[Md.26] Axis operation status" is "1: Stopped". If the positioning start signal is turned OFF→ON while "[Md.26] Axis operation status" is stopped, the normal positioning (using the positioning data set in ("[Cd.3] Positioning start No.") is started.
- If PLC READY signal is turned OFF→ON while "[Md.26] Axis operation status" is "1: Stopped", the positioning control cannot be restarted. If a restart request is issued, Restart not possible (Warning code: 0902H) occurs.
- Do not execute restarting while the stop command is on. If restarting is attempted while the stop command is ON, Stop signal ON at start (Error code: 1908H or 1909H) occurs and "[Md.26] Axis operation status" turns to "-1: Error". In this case, even if the error is reset, the operation cannot be restarted.
- If the positioning is ended with the continuous operation interrupt request, the operation cannot be restarted. If a restart request is issued, Restart not possible (Warning code: 0902H) occurs.
- When the positioning has been stopped with the interpolation operation, write "1: Restart" into "[Cd.6] Restart command" for the reference axis and restart the positioning.
- If any of the reference partner axes implements the positioning operation once, Restart not possible (Warning code: 0902H) occurs, and the positioning cannot be restarted.
- When the machine OPR and fast OPR is stopped, OPR restart not possible (Error code: 1946H) occurs and the positioning cannot be restarted.
- When the manual operation is stopped, Restart not possible (Warning code: 0902H) occurs and the positioning cannot be restarted.

Setting method

Set the following data to restart the positioning.

Setting item	Setting value	Setting detail	Buffer memory address	
			Axis 1	Axis 2
[Cd.6] Restart command	1	Set "1: Restart".	1503	1603

For details on the settings, refer to the following.

☞ Page 471 [Cd.6] Restart command

Restart time chart

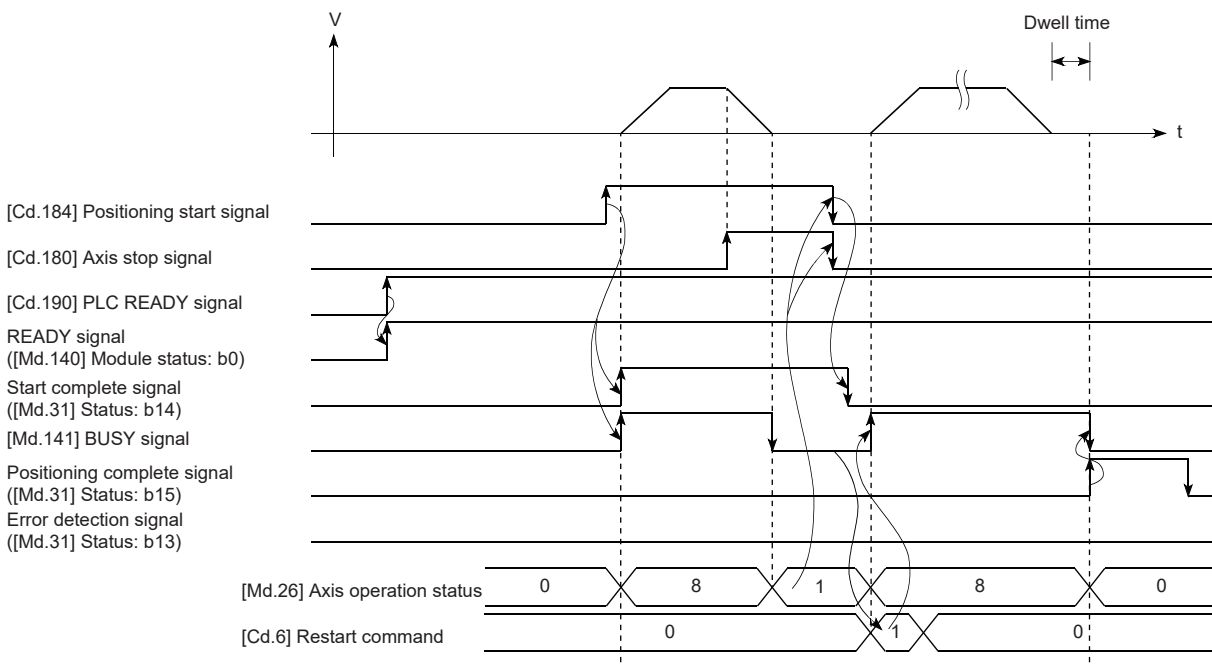

Program example

For the program example of the restart, refer to the following.

☞ Page 509 Restart program

8 OPR CONTROL

This chapter describes the details and usage of the OPR control.

8.1 Overview of the OPR Control

Two types of OPR controls

The OPR control establishes a start point (= OP) for performing the positioning control, and implements positioning toward that start point. This control is used to return the machine system located at a position other than the OP to the OP when the positioning module issues an OPR request with the power turned ON or after the positioning stops.

In the positioning module, the two types of controls shown below are defined as OPR control, following the flow of the OPR work. These two types of OPR controls can be implemented by setting the OPR parameter, setting "Positioning start No.9001" and "Positioning start No. 9002" originally prepared for the positioning module in "[Cd.3] Positioning start No.", and turning ON the positioning start signal.

OPR method	Description
Machine OPR (Positioning start No.9001)	Performs the OPR operation to establish a machine OP position. Subsequent positioning control operations are performed with reference to the OP established after the OPR operation is completed. When the system is turned ON and a machine OP has yet to be established (the current value that the positioning module monitors and the actual machine position do not match), machine OPR needs to be implemented.
Fast OPR (Positioning start No.9002)	Performs the positioning toward the OP established by the machine OPR. Specifying positioning start No.9002 performs the fast OPR. Thus, the positioning to the OP can be performed without setting positioning data.

The OPR control can be performed by setting 9001 or 9002 for the start No. of the dedicated instruction GP.PSTRT□. For details on the dedicated instructions, refer to the following.

 MELSEC iQ-F FX5 Programming Manual (Instructions, Standard Functions/Function Blocks)

To perform Fast OPR, perform Machine OPR beforehand.

Restriction

In the following cases, the positioning module turns ON the OPR request flag ([Md.31] Status: b3), which indicates that machine OPR needs to be implemented.

- When the power is turned ON
- When the drive unit READY signal ([Md.30] External I/O signal: b2) turns ON→OFF
- When "[Cd.190] PLC READY signal" turns OFF→ON

While the OPR request flag is ON, the address information stored in the positioning module is not assured. When implementation of the machine OPR finishes normally, the OPR request flag turns OFF and the OPR complete flag ([Md.31] Status: b4) turns ON.

Sub functions specific to OPR

For details on Sub functions that can be combined with the OPR control, refer to the following.

 Page 34 Combining Main and Sub Functions

For details on each sub function, refer to the following.

 Page 218 CONTROL SUB FUNCTION

[Information]

The following two sub functions are only related to the machine OPR.

○: Combinations possible

△: Limits ON

×: Cannot be combined

Sub function name	Machine OPR	Fast OPR	Reference
OPR retry function	△	×	Page 220
OP shift function	○	×	Page 224

When no OPR is required

In a system that does not need any OPR operation, the OPR request flag ([Md.31] Status: b3) can be ignored to implement the positioning. In this case, set all OPR parameter areas ([Pr.43] to [Pr.57]) to their default values or values that do not cause errors.

OPR from GX Works3

Machine OPR and Fast OPR can be implemented using the positioning test in GX Works3. For details on the positioning test, refer to the following.

☞ Page 340 Positioning Test

8.2 Machine OPR

Operation overview of the machine OPR



Use the OPR retry function when the OP position is not always in the same direction from the workpiece operation area (when the OP is not set near the upper or lower limit of the machine). The machine OPR may not be completed unless the OPR retry function is used.

Machine OPR operation

In the machine OPR, a machine OP is established. This operation does not use the address information in the positioning module, CPU module, and servo amplifiers at all.

After the machine OPR is completed, the mechanically specified position is handled as the OP, the start point for the positioning control.

The method for establishing an OP by the machine OPR depends on the setting of [Pr.43] OPR method.

The following shows the operation after the machine OPR is started.

1. The machine OPR is started.
2. The operation starts according to the speed and direction set in the OPR parameters ([Pr.43] to [Pr.57]).
3. The OP is established using the method set in [Pr.43] OPR method, and the operation stops. (Refer to ☞ Page 83 Near-point dog method to Page 97 Data setting method)
4. If "a" is set as [Pr.45] OP address, "a" will be stored as the current position in [Md.20] Current feed value and [Md.21] Machine feed value which have been monitoring the position.
5. The machine OPR is completed.

[Pr.45] OP address is a fixed value set by users.

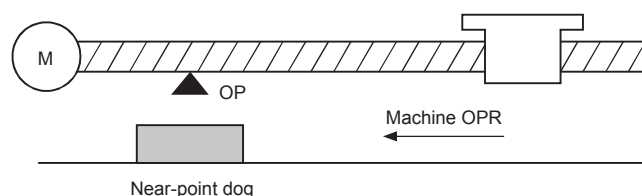

Machine OPR method

In the machine OPR, the method by which the machine OP is established (method for judging the position of the OP and the completion of the machine OPR) is specified according to the configuration and application of the positioning system.

The following table shows the seven methods provided as the OPR methods. The OPR method is one of the setting items of the OPR parameter and set in "[Pr.43] OPR method".

[Pr.43] OPR method	Operation
Near-point dog method	The deceleration starts on the rising edge of Near-point dog. (The speed is reduced to "[Pr.47] Creep speed".) After Near-point dog turns from ON→OFF, the workpiece stops at the first input of zero signals ^{*1} . The machine OPR is completed when the deviation counter clear output is completed. The position is set as an OP.
Stopper method 1	The point where a stopper is placed is set as an OP. After the deceleration starts on the rising edge of the near-point dog, the machine presses the workpiece against the stopper at the speed set in [Pr.47] Creep speed and stops. After the stop and the time set in [Pr.49] OPR dwell time elapses, the machine OPR is completed when the deviation counter clear output is completed.
Stopper method 2	The point where a stopper is placed is set as an OP. After the deceleration starts on the rising edge of the near-point dog, the machine presses the workpiece against the stopper at the speed set in [Pr.47] Creep speed and stops. After the stop and Zero signal ^{*2} is detected, the machine OPR is completed when the deviation counter clear output is completed.
Stopper method 3	The point where a stopper is placed is set as an OP. The machine starts at the speed set in [Pr.47] Creep speed from the beginning, presses the workpiece against the stopper and stops. After the stop and Zero signal ^{*2} is detected, the machine OPR is completed when the deviation counter clear output is completed.
Count method 1	After moving the distance set in [Pr.50] Setting for the movement amount after near-point dog ON from the point where the near-point dog turns on, the machine stops at the first input of zero signals ^{*1} . The position where the machine stops is set as an OP. The deceleration starts on the rising edge of the near-point dog and the machine moves at the speed set in [Pr.47] Creep speed. After moving the distance set in [Pr.50] Setting for the movement amount after near-point dog ON from the point where the near-point dog turns on, the machine stops at the first input of zero signals ^{*1} . When the deviation counter clear output is completed, the machine OPR is completed.
Count method 2	After moving the distance set in [Pr.50] Setting for the movement amount after near-point dog ON from the point where the near-point dog turns on, the machine stops. The position where the machine stops is set as an OP. The deceleration starts on the rising edge of the near-point dog and the machine moves at the speed set in [Pr.47] Creep speed. After moving the distance set in [Pr.50] Setting for the movement amount after near-point dog ON from the point where the near-point dog turns on, the machine stops and the machine OPR is completed.
Data setting method	The point where the machine OPR starts is set as an OP. After the deviation counter clear output is completed, "[Md.20] Current feed value" and "[Md.21] Machine feed value" are overwritten using "[Pr.45] OP address", and the machine OPR is completed.
Limit switch combined-use method	After execution, the machine starts moving towards the OPR direction. The deceleration stop can be executed by turning off the limit switch, and the machine will move in the opposite direction at the speed set in "[Pr.47] Creep speed". From the point where the limit switch turns on, the machine stops at the first input of zero signals ^{*1} . When the deviation counter clear output is completed, the machine OPR is completed.

*1 Signals that output 1 pulse (e.g., Phase Z signals output from the drive unit) per motor revolution are input as positioning module Zero signals.

*2 Signals output after detecting contact with the stopper are input as positioning module Zero signals.

The following table shows the external I/O signals used for the machine OPR.

- ◎: Required
- : Use as necessary
- : Not required

[Pr.43] OPR method	Signal required for control				Torque limit
	Near-point dog	Zero signal	Upper/lower limit switches	Deviation counter clear output	
Near-point dog method	◎	◎	○	◎	—
Stopper method 1	◎	—	○	◎	◎
Stopper method 2	◎	◎	○	◎	◎
Stopper method 3	—	◎	○	◎	◎
Count method 1	◎	◎	○	◎	—
Count method 2	◎	—	○	—	—
Data setting method	—	—	—	◎	—
Limit switch combined-use method	—	◎	◎	◎	—

Point 

Creep speed

A creep speed is very slow. The stopping accuracy is low when the machine suddenly stops from a fast speed. To improve the stopping accuracy of the machine, change the speed to a slow speed. Set this speed in [Pr.47] Creep speed.

Near-point dog method

The following shows an operation overview of the near-point dog method, one of the OPR methods.

Operation chart

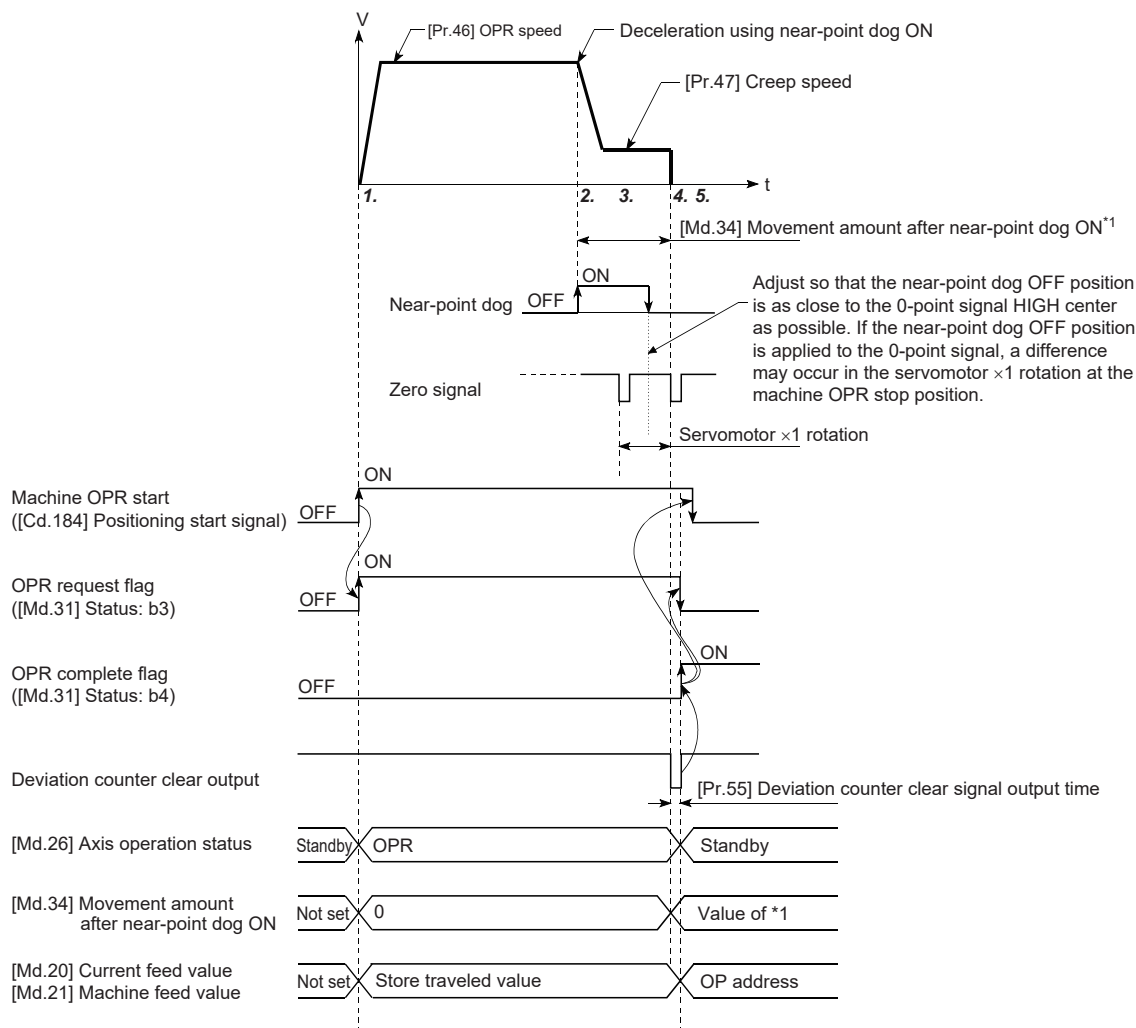

1. The machine OPR is started. (The machine starts accelerating according to the setting of "[Pr.51] OPR acceleration time selection" in the direction specified in "[Pr.44] OPR direction", and moves at the speed set in "[Pr.46] OPR speed" when the acceleration is completed.)
2. When the on state of the near-point dog is detected, the machine starts decelerating.
3. The machine decelerates to the speed set in [Pr.47] Creep speed and moves at the creep speed after that. (During the deceleration, the near-point dog must be ON. Otherwise a deceleration stop will occur.)
4. After the near-point dog turns OFF and at the first input of zero signals, the positioning module stops outputting pulses and outputs "Deviation counter clear output" to the drive unit. (Deviation counter clear signal output time is set in [Pr.55].)
5. After "Deviation counter clear" output finishes, the OPR complete flag ([Md.31] Status: b4) turns OFF→ON, and the OPR request flag ([Md.31] Status: b3) turns ON→OFF.

Restrictions

A pulse generator with a zero signal is required. When using a pulse generator without a zero signal, produce a zero signal using an external signal.

Precautions during the operation

- Start at OP (Error code: 1940H) will occur if another machine OPR is attempted after the completion of the machine OPR when the OPR retry function has not been set ([Pr.48] OPR retry is 0).
- When the machine OPR is started at a point where the near-point dog is on, the machine starts moving at the speed set in [Pr.47] Creep speed.
- The near-point dog must be on during the deceleration from the OPR speed to the speed set in [Pr.47] Creep speed. The workpiece will continue decelerating and stop if the near-point dog is turned OFF before it has decelerated to the creep speed, causing a dog detection timing fault (Error code: 1941H).

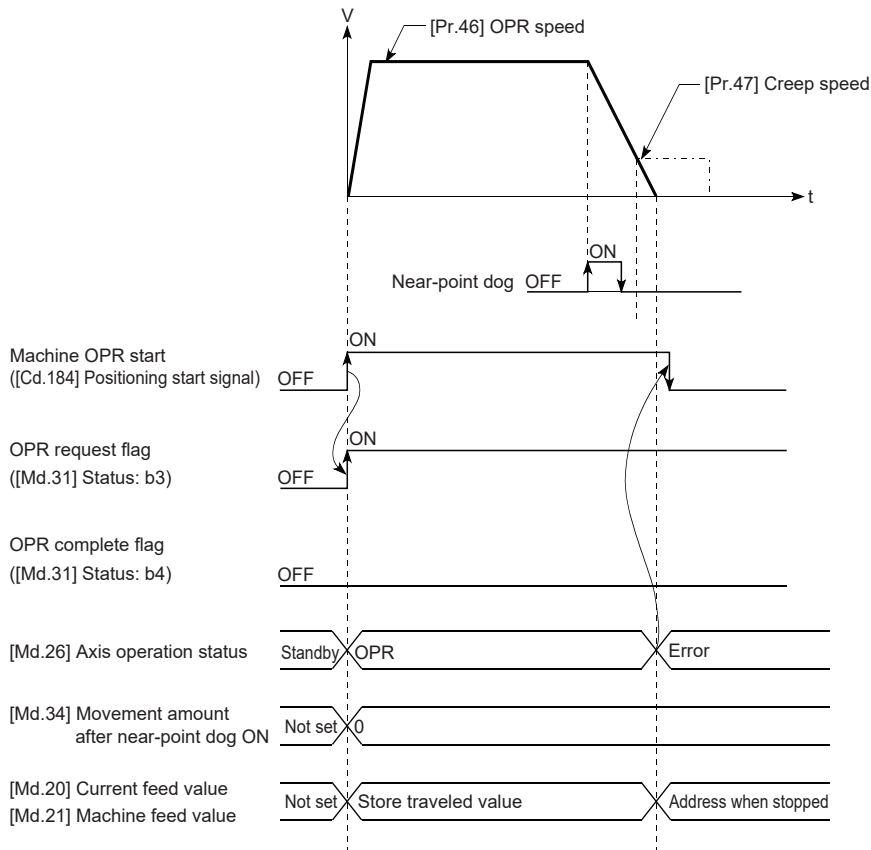

- If the OPR retry function has not been set ([Pr.48] OPR retry is 0) and an OPR operation is implemented as described above, the machine moves until it reaches a limit switch and Hardware stroke limit (+)/Hardware stroke limit (-) (Error code: 1905H/1907H) will occur. In this case, perform the manual control to move the workpiece to a position closer to the start position than the near-point dog and perform the OPR operation again.
- When the machine OPR has been stopped by a stop signal, perform the machine OPR again. If the restart command is turned ON after the stop by a stop signal, OPR restart not possible (Error code: 1946H) occurs.

Stopper method 1

The following shows an operation overview of the stopper method 1, one of the OPR methods.

Operation chart

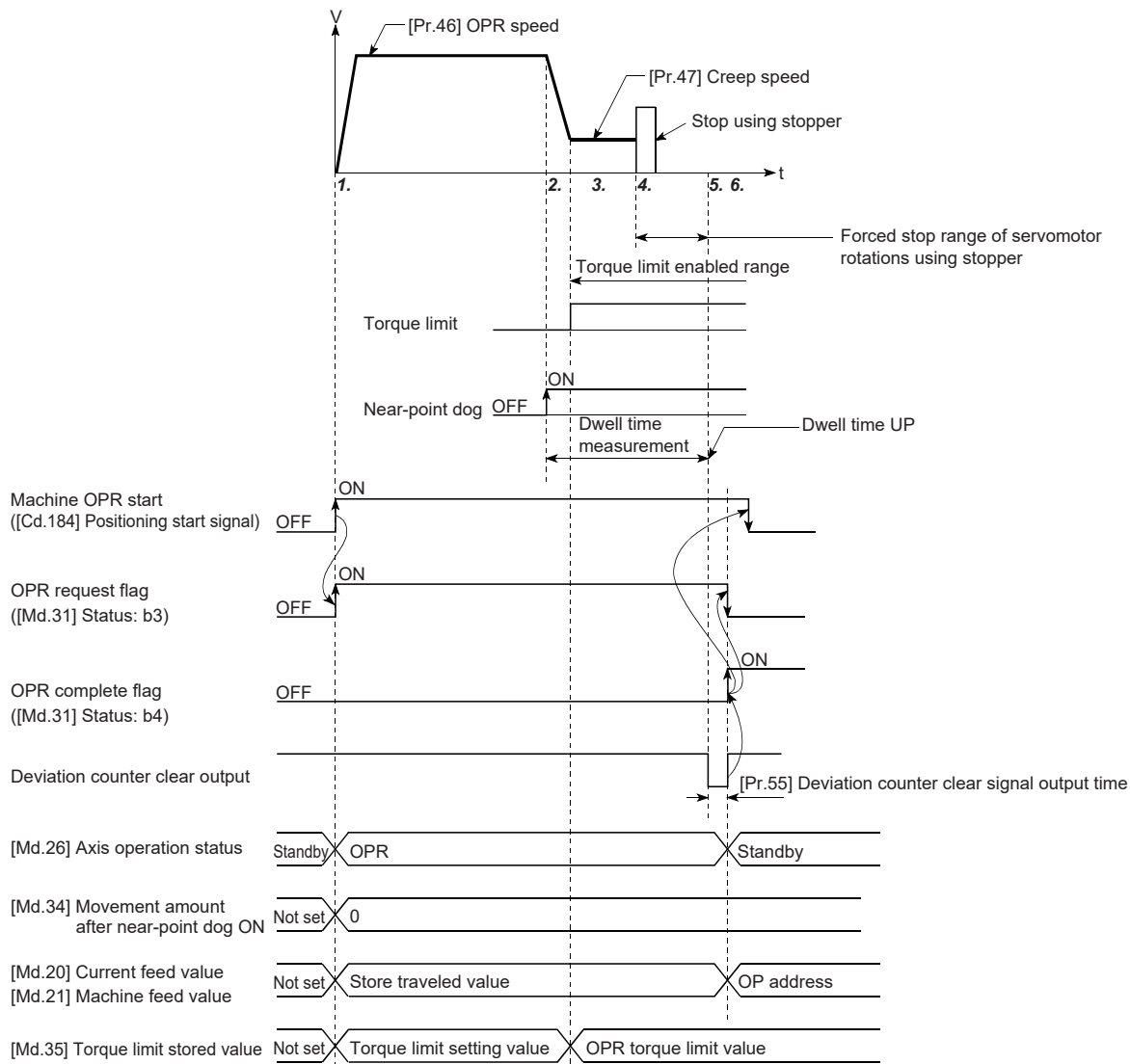

1. The machine OPR is started. (The machine starts accelerating according to the setting of "[Pr.51] OPR acceleration time selection" in the direction specified in "[Pr.44] OPR direction", and moves at the speed set in "[Pr.46] OPR speed" when the acceleration is completed.)
2. When the on state of the near-point dog is detected, the machine starts decelerating.
3. The machine decelerates to the speed set in [Pr.47] Creep speed and moves at the creep speed after that. (At this time, the torque must be limited. If the torque is not limited, the servomotor may be damaged in Step 4.)
4. The machine presses the workpiece against the stopper at the creep speed and stops.
5. When the time set in [Pr.49] OPR dwell time has elapsed after the near-point dog was turned ON, the positioning module stops outputting pulses and outputs a "Deviation counter clear output" to the drive unit. (Deviation counter clear signal output time is set in [Pr.55].)
6. After "Deviation counter clear" output finishes, the OPR complete flag ([Md.31] Status: b4) turns OFF→ON, and the OPR request flag ([Md.31] Status: b3) turns ON→OFF.

Restrictions

Always limit the servomotor torque after the speed reaches the speed set in [Pr.47] Creep speed.

Otherwise the servomotor may be damaged when the workpiece hits the stopper. ( Page 239 Torque limit function)

Precautions during the operation

- Set [Pr.49] OPR dwell time to the time that is equal to or longer than the movement time taken from when the near-point dog turns on to when the workpiece hits the stopper.
- The machine will continue decelerating and stop if the time set in [Pr.49] OPR dwell time elapses during the deceleration from the speed set in [Pr.46] OPR speed, and Dwell time fault (Error code: 1943H) occurs.

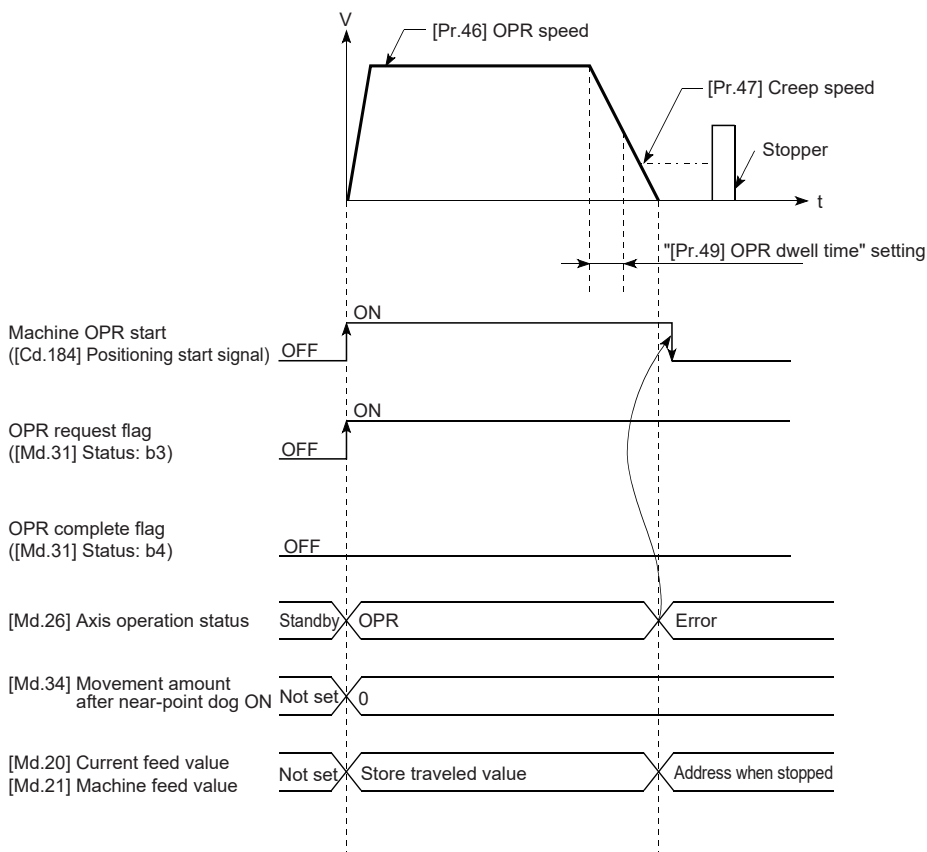

- If the time set in [Pr.49] OPR dwell time elapses before stopping at the stopper, the workpiece will stop at that position, and the position will be set as an OP. In this case, no error will occur.

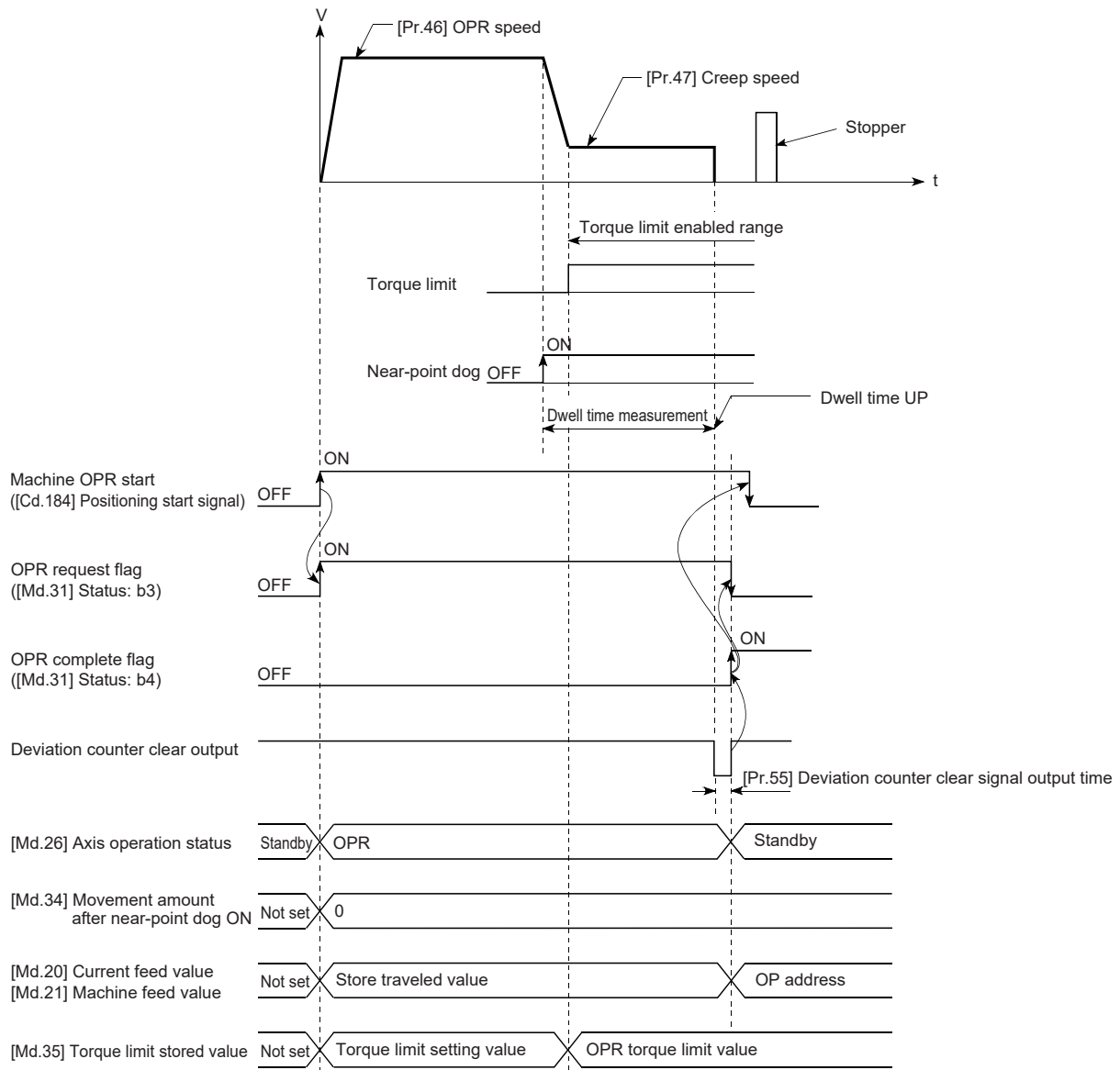

- The near-point dog must be on until the workpiece hits the stopper. If there is a section in which the near-point dog is off between the near point dog and the stopper, and a machine OPR operation is executed from a point in the section, the workpiece will hit the stopper at the OPR speed.
- If the machine OPR is started while the near-point dog is on, the workpiece starts traveling at the speed set in [Pr.47] Creep speed.
- When the machine OPR has been stopped by a stop signal, perform the machine OPR again. If the restart command is turned ON after the stop by a stop signal, OPR restart not possible (Error code: 1946H) occurs.

Stopper method 2

The following shows an operation overview of the stopper method 2, one of the OPR methods.

Operation chart

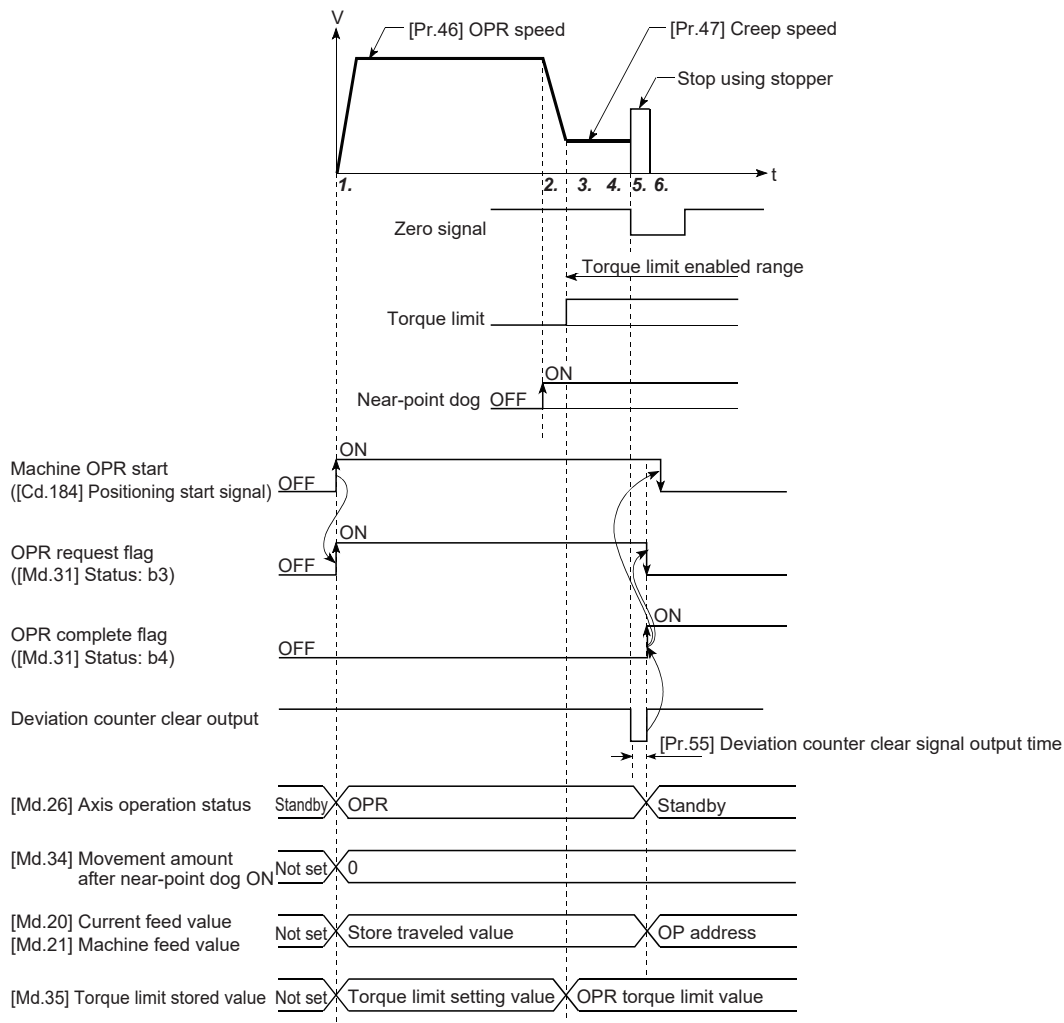

1. The machine OPR is started. (The machine starts accelerating according to the setting of "[Pr.51] OPR acceleration time selection" in the direction specified in "[Pr.44] OPR direction", and moves at the speed set in "[Pr.46] OPR speed" when the acceleration is completed.)
2. When the on state of the near-point dog is detected, the machine starts decelerating.
3. The machine decelerates to the speed set in [Pr.47] Creep speed and moves at the creep speed after that. (At this time, the torque must be limited. If the torque is not limited, the servomotor may be damaged in Step 4.)
4. The machine presses the workpiece against the stopper at the creep speed and stops.
5. After the stop and a zero signal is input, the positioning module stops outputting pulses and outputs a "Deviation counter clear output" to the drive unit. (Deviation counter clear signal output time is set in [Pr.55].)
6. After "Deviation counter clear" output finishes, the OPR complete flag ([Md.31] Status: b4) turns OFF→ON, and the OPR request flag ([Md.31] Status: b3) turns ON→OFF.

Restrictions

- Always limit the servomotor torque after the speed reaches the speed set in [Pr.47] Creep speed. Otherwise the servomotor may be damaged when the workpiece hits the stopper. ( Page 239 Torque limit function)
- Use an external input signal as a zero signal.

Precautions during the operation

- Input a zero signal from an external source after the workpiece hits to the stopper. If a zero signal is input before the deceleration to the speed set in [Pr.47] Creep speed is completed, the machine will continue decelerating and stop and Zero signal detection timing fault (Error code: 1942H) will occur.

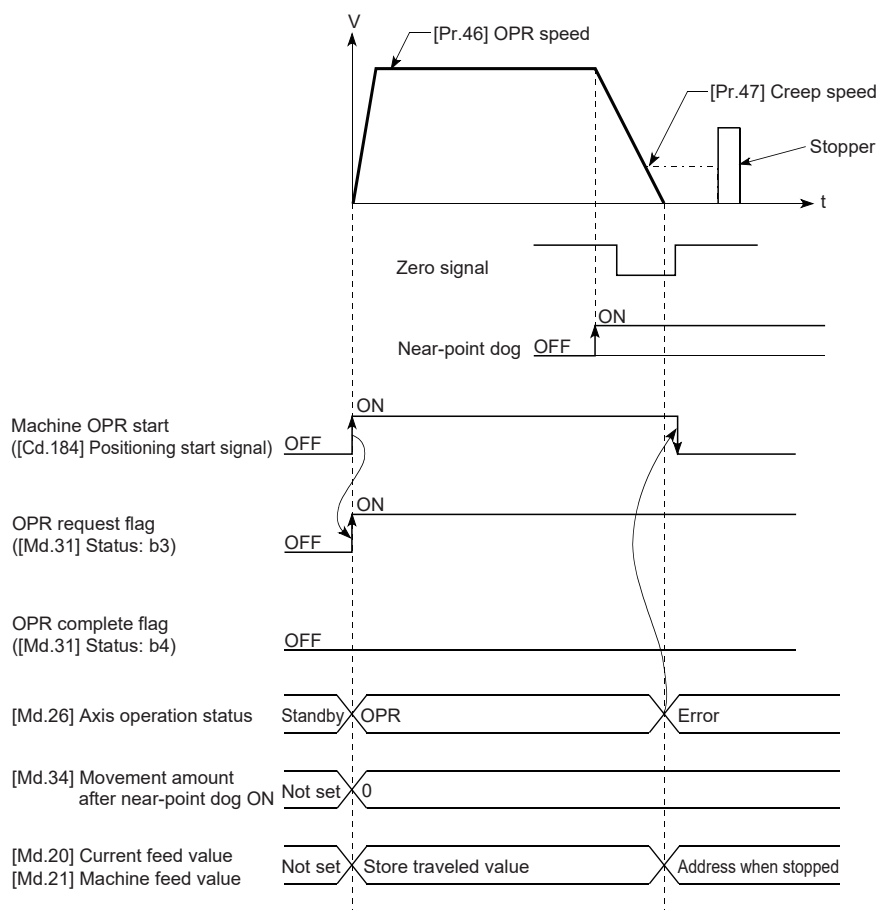

- If a zero signal is input before the workpiece stops at the stopper, the workpiece stops at that position and the position is set as an OP. In this case, no error will occur.

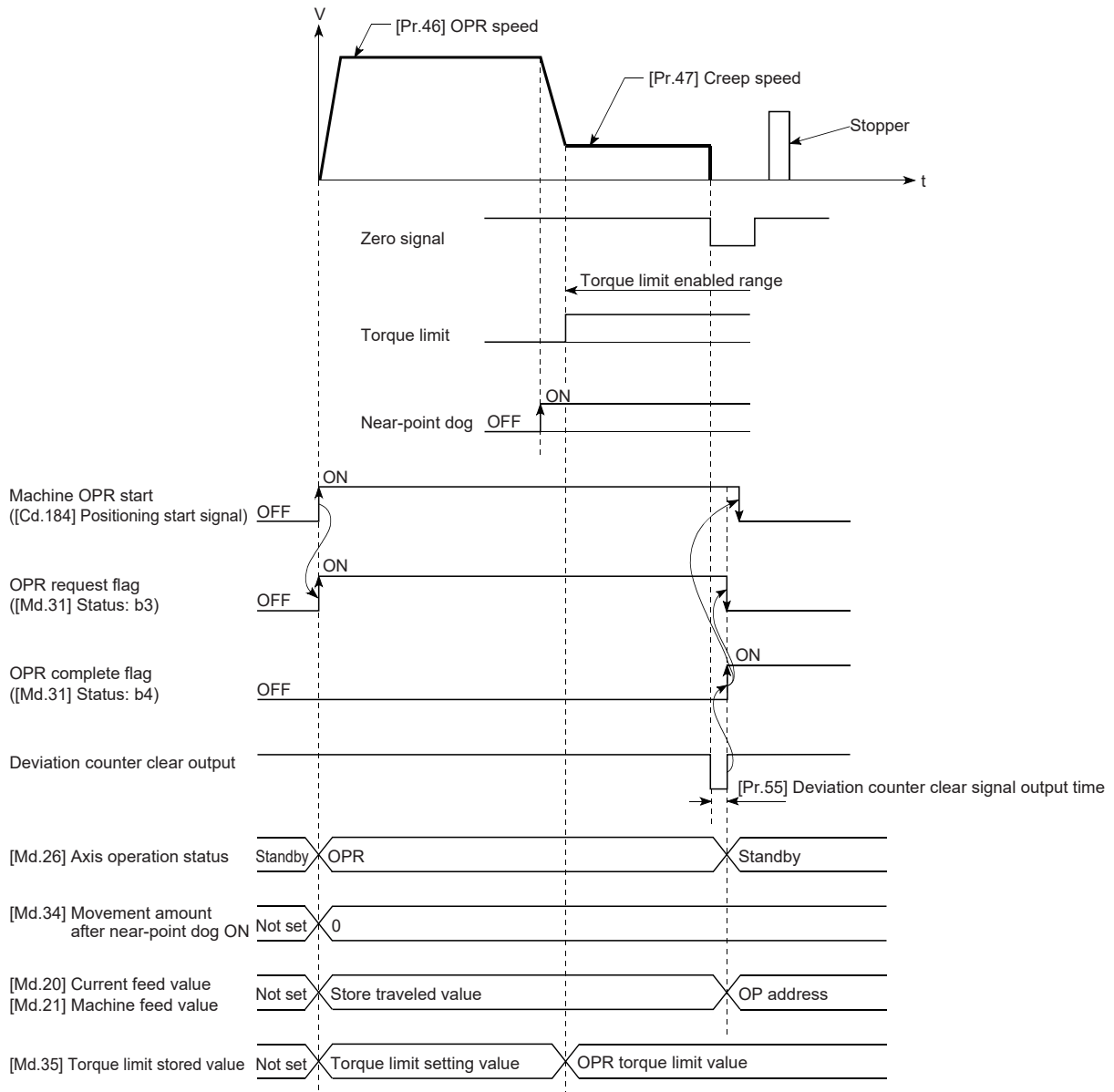

- The near-point dog must be on until the workpiece hits the stopper. If there is a section in which the near-point dog is off between the near point dog and the stopper, and a machine OPR operation is executed from a point in the section, the workpiece will hit the stopper at the OPR speed.
- If the machine OPR is started while the near-point dog is on, the workpiece starts traveling at the speed set in [Pr.47] Creep speed.
- When the machine OPR has been stopped by a stop signal, perform the machine OPR again. If the restart command is turned ON after the stop by a stop signal, OPR restart not possible (Error code: 1946H) occurs.

Stopper method 3

The following shows an operation overview of the stopper method 3, one of the OPR methods.

Stopper method 3 is useful for a system in which a near-point dog cannot be installed. (Note that the workpiece starts traveling at the speed set in "[Pr.47] Creep speed", which means that it takes some time until the machine OPR is completed.)

Operation chart

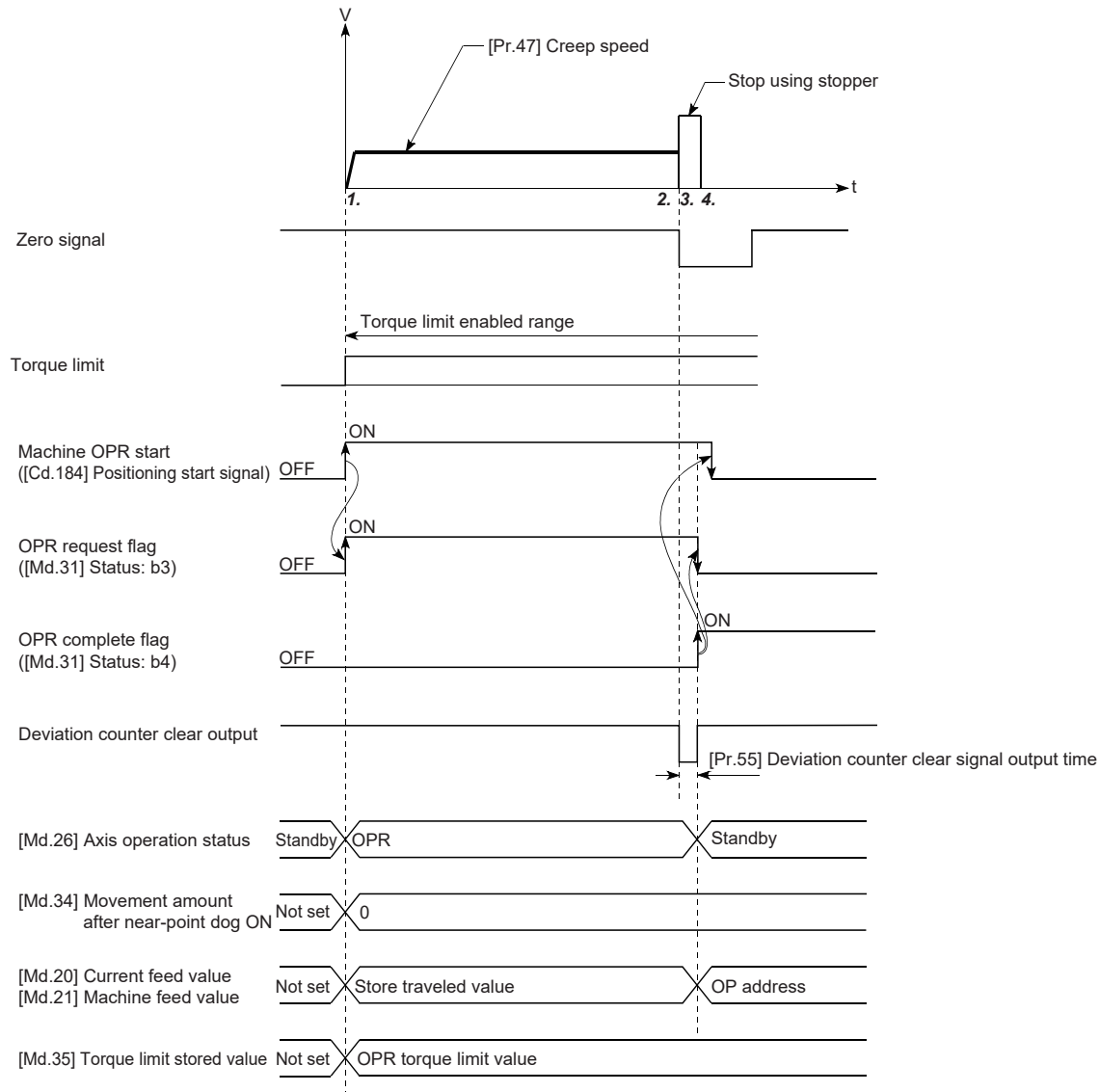

1. The machine OPR is started. (The machine moves at the speed set in "[Pr.47] Creep speed" in the direction specified in "[Pr.44] OPR direction" The torque must be limited for this operation. If the torque is not limited, the servomotor may be damaged in Step 2.)
2. The machine presses the workpiece against the stopper at the speed set in [Pr.47] Creep speed and stops.
3. After the stop and a zero signal is input, the positioning module stops outputting pulses and outputs a "Deviation counter clear output" to the drive unit. (Deviation counter clear signal output time is set in [Pr.55].)
4. After "Deviation counter clear" output finishes, the OPR complete flag ([Md.31] Status: b4) turns OFF→ON, and the OPR request flag ([Md.31] Status: b3) turns ON→OFF.

Restrictions

- Always limit the servomotor torque after the speed reaches the speed set in [Pr.47] Creep speed. Otherwise the servomotor may be damaged when the workpiece hits the stopper. ( Page 239 Torque limit function)
- Use an external input signal as a zero signal.
- The OPR retry function cannot be used for Stopper method 3.

Precautions during the operation

- If a zero signal is input before the workpiece stops at the stopper, the workpiece stops at that position and the position is set as an OP. In this case, no error will occur.



- When the machine OPR has been stopped by a stop signal, perform the machine OPR again. If the restart command is turned ON after the stop by a stop signal, OPR restart not possible (Error code: 1946H) occurs.

Count method 1

The following shows an operation overview of Count method 1, one of the OPR methods. If a machine OPR operation is started using Count method 1 from a point where the near-point dog is ON, the machine moves in the reverse direction to the OPR direction to return to a point where the near-point dog turns OFF, and a normal machine OPR operation is implemented. The machine OPR can be implemented using Count method 1 even in the following situations.

- Where the near-point dog is on
- After the machine OPR is completed

Operation chart

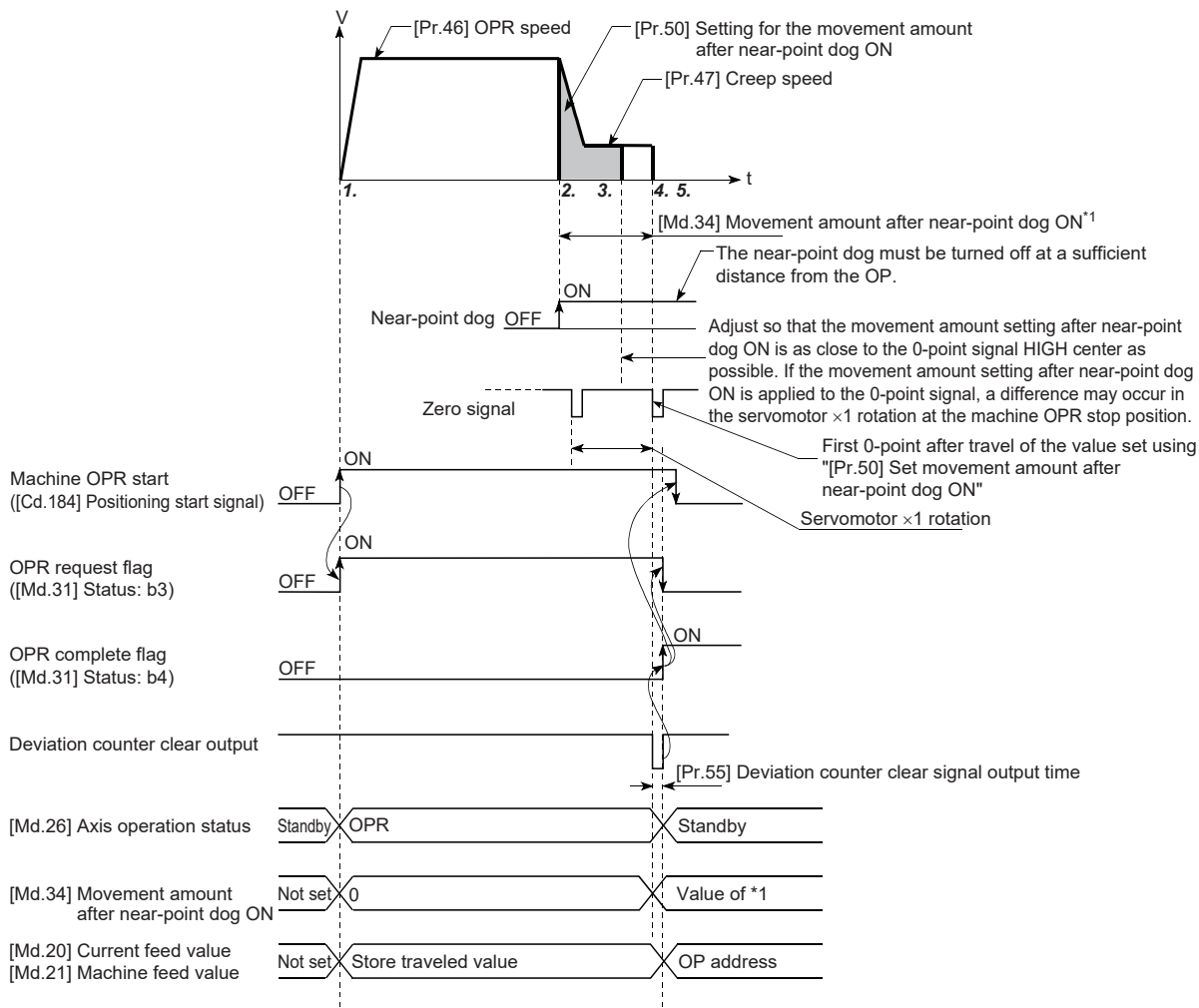

1. The machine OPR is started. (The machine starts accelerating according to the setting of "[Pr.51] OPR acceleration time selection" in the direction specified in "[Pr.44] OPR direction", and moves at the speed set in "[Pr.46] OPR speed" when the acceleration is completed.)
2. When the on state of the near-point dog is detected, the machine starts decelerating.
3. The machine decelerates to the speed set in [Pr.47] Creep speed and moves at the creep speed after that.
4. When the first zero signal is detected after the axis has traveled the movement amount set in "[Pr.50] Setting for the movement amount after near-point dog ON" from the point where the near-point dog is turned ON, the positioning module stops outputting pulses and outputs a "Deviation counter clear output" to the drive unit. (Deviation counter clear signal output time is set in [Pr.55].)
5. After the "Deviation counter clear output" finishes, the OPR complete flag ([Md.31] Status: b4) turns OFF→ON, and the OPR request flag ([Md.31] Status: b3) turns ON→OFF.

Restrictions

A pulse generator with a zero signal is required. When using a pulse generator without a zero signal, produce a zero signal using an external signal.

Precautions during the operation

- If the distance set in "[Pr.50] Setting for the movement amount after near-point dog ON" is shorter than the deceleration distance from "[Pr.46] OPR speed" to deceleration stop, a Count method movement amount fault (Error code: 1944H) occurs and the operation does not start.
- If the speed is changed to a speed faster than the speed set in [Pr.46] OPR speed using the speed change function ( Page 250 Speed change function) during a machine OPR operation, the distance required for deceleration stop may not be assured depending on the setting of "[Pr.50] Setting for the movement amount after near-point dog ON". In this case, Count method movement amount fault (Error code: 1944H) occurs and the machine OPR is stopped.
- The following shows the operation performed when the machine OPR is started while the near-point dog is on.

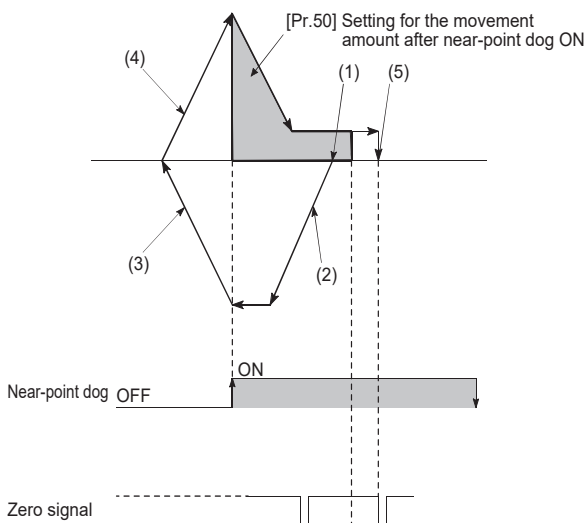

[Operation when the machine OPR is started from a point where the near-point dog is on]

- (1) A machine OPR is started.
- (2) The machine moves at the OPR speed in the direction reverse to the specified OPR direction.
- (3) The deceleration processing is performed according to the setting of [Pr.39] Stop group 3 sudden stop selection when the OFF state of the near-point dog is detected.
- (4) After the machine stops, the machine OPR is performed in the specified OPR direction.
- (5) The machine OPR is completed after the deviation counter clear output is provided on the detection of the first zero signal after the workpiece travels for the movement amount set in [Pr.50] Setting for the movement amount after near-point dog ON from the point where the ON state of the near-point dog is detected.

- The near-point dog must be turned off at a sufficient distance from the OP. There is no harm in operation even if the near-point dog is turned off during a machine OPR. However, ensuring a sufficient distance from the OP is recommended for the following reasons when the near-point dog is turned off.
 - (1) If the workpiece is at a point where the near-point dog is still ON when the machine OPR is completed, another machine OPR can be implemented from that point even though the OPR complete flag ([Md.31] Status: b4) is ON.
 - (2) If the workpiece is at a point where the near-point dog is OFF when the machine OPR is completed and another OPR is implemented, the workpiece travels at the OPR speed until it reaches a limit switch. This causes Hardware stroke limit (+)/Hardware stroke limit (-) (Error code: 1905H/1907H). If a sufficient distance cannot be ensured for Near-point dog signal to be turned on, use the OPR retry function. When the OPR retry function is used, a retry operation can be performed using limit switches.
- When the machine OPR has been stopped by a stop signal, perform the machine OPR again. If the restart command is turned ON after the stop by a stop signal, OPR restart not possible (Error code: 1946H) occurs.

Count method 2

The following shows an operation overview of Count method 2, one of the OPR methods.

If a machine OPR operation is started using Count method 2 from a point where the near-point dog is ON, the machine moves in the direction reverse to the OPR direction to return a point where the near-point dog turns OFF, and a normal machine OPR operation is implemented.

Count method 2 is useful for a system that cannot use zero signals. (Note that compared with Count method 1, the stop position in the machine OPR varies.)

As well as Count method 1, the machine OPR operation can be implemented using Count method 2 even in the following situations.

- Where the near-point dog is on
- After the machine OPR is completed

Operation chart

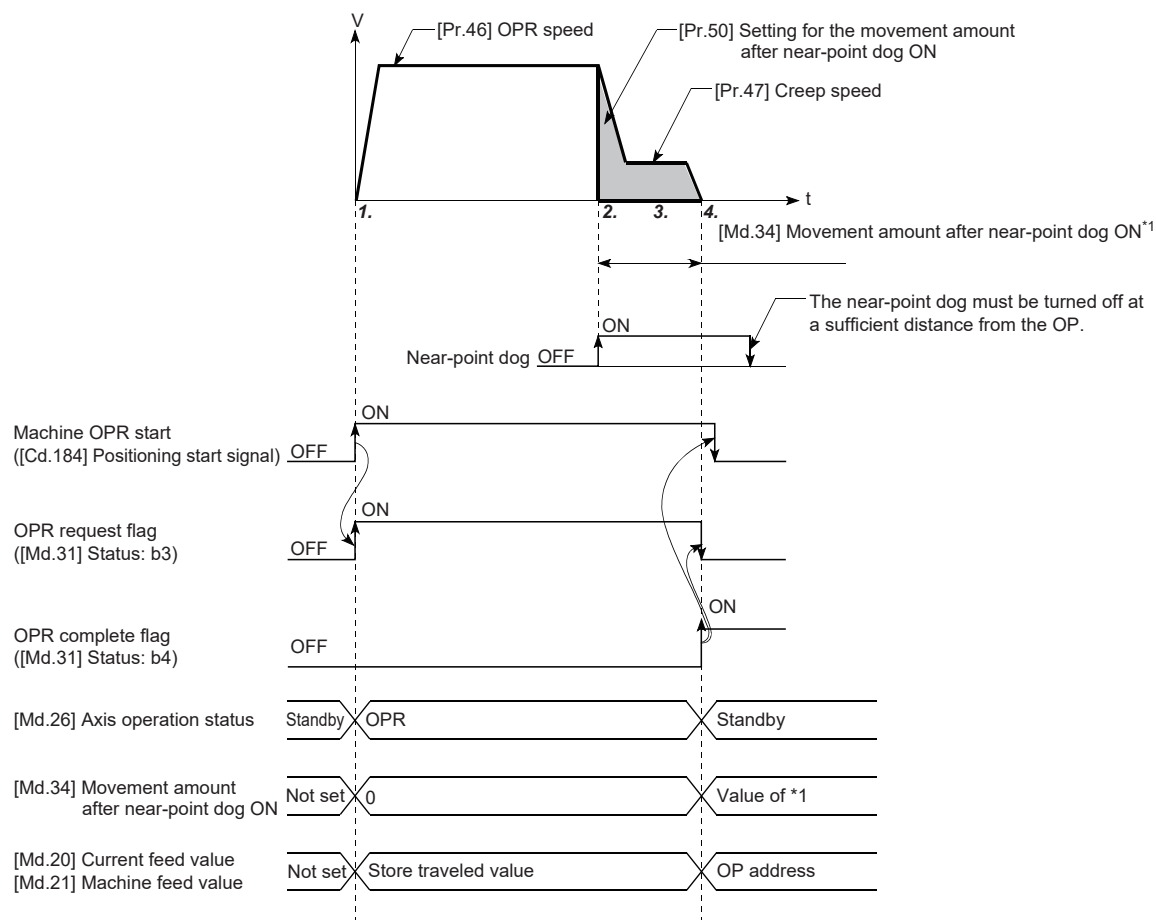

1. The machine OPR is started. (The machine starts accelerating according to the setting of "[Pr.51] OPR acceleration time selection" in the direction specified in "[Pr.44] OPR direction", and moves at the speed set in "[Pr.46] OPR speed" when the acceleration is completed.)
2. When the on state of the near-point dog is detected, the machine starts decelerating.
3. The machine decelerates to the speed set in [Pr.47] Creep speed and moves at the creep speed after that.
4. When the machine moves the movement amount set in "[Pr.50] Setting for the movement amount after near-point dog ON" from the point where the near-point dog signal turns ON, the positioning module stops outputting pulses and the machine OPR finishes.

Restrictions

Since an error of approximately 1 ms occurs in taking in the ON state of the near-point dog, the stop position (OP) varies compared to other OPR methods.

Precautions during the operation

- If the distance set in "[Pr.50] Setting for the movement amount after near-point dog ON" is shorter than the deceleration distance from "[Pr.46] OPR speed" to deceleration stop, a Count method movement amount fault (Error code: 1944H) occurs and the operation does not start. Depending on the set value of "[Pr.50] Setting for the movement amount after near-point dog ON", when the travel amount set after the near-point dog turns ON is reached, a warning "Insufficient travel amount (Warning code: H0998)" occurs, and the machine OPR stops suddenly. Further, if the travel amount set in "[Pr.50] Setting for the movement amount after near-point dog ON" is reached before the creep speed is reached, a "Count method movement amount fault (Error code: H1944)" occurs.
- If the speed is changed to a speed faster than the speed set in [Pr.46] OPR speed using the speed change function (☞ Page 250 Speed change function) during a machine OPR operation, the distance required for deceleration stop may not be assured depending on the setting of "[Pr.50] Setting for the movement amount after near-point dog ON". In this case, a Count method movement amount fault (Error code: 1944H) occurs and the machine OPR is stopped.
- The following shows the operation performed when the machine OPR is started while the near-point dog is on.

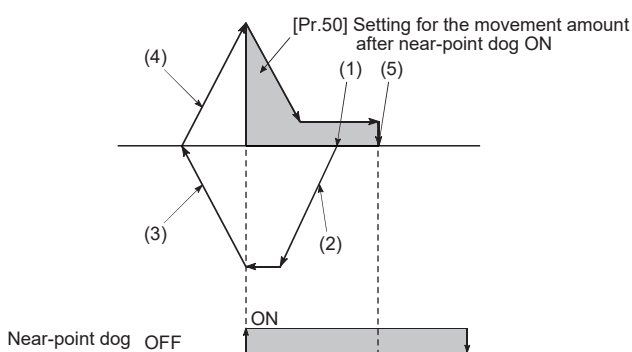

[Operation when the machine OPR is started from a point where the near-point dog is on]

- (1) A machine OPR is started.
 - (2) The machine moves at the OPR speed in the direction reverse to the specified OPR direction.
 - (3) The deceleration processing is performed according to the setting of [Pr.39] Stop group 3 sudden stop selection when the OFF state of the near-point dog is detected.
 - (4) After the machine stops, the machine OPR is performed in the specified OPR direction.
 - (5) When the machine moves for the movement amount set in [Pr.50] Setting for the movement amount after near-point dog ON from the point where the on state of the near-point dog is detected, the machine OPR will be completed.
- The near-point dog must be turned off at a sufficient distance from the OP. There is no harm in operation even if the near-point dog is turned off during a machine OPR. However, ensuring a sufficient distance from the OP is recommended for the following reasons when the near-point dog is turned off.
 - (1) If the workpiece is at a point where the near-point dog is still ON when the machine OPR is completed, another machine OPR can be implemented from that point even though the OPR complete flag ([Md.31] Status: b4) is ON.
 - (2) If the workpiece is at a point where the near-point dog is OFF when the machine OPR is completed and another OPR is implemented, the workpiece travels at the OPR speed until it reaches a limit switch. This causes Hardware stroke limit (+)/Hardware stroke limit (-) (Error code: 1905H/1907H). If a sufficient distance cannot be ensured for Near-point dog signal to be turned on, use the OPR retry function. When the OPR retry function is used, a retry operation can be performed using limit switches.
 - When the machine OPR has been stopped by a stop signal, perform the machine OPR again. If the restart command is turned ON after the stop by a stop signal, OPR restart not possible (Error code: 1946H) occurs.

Data setting method

Data setting method is used to set a point at which the workpiece is positioned by a manual feed such as JOG operation as an OP.

When the machine OPR is performed using the data setting method, Deviation counter clear signal is output to the drive unit and the current feed value and machine feed value are overwritten with the OP address.

Operation chart

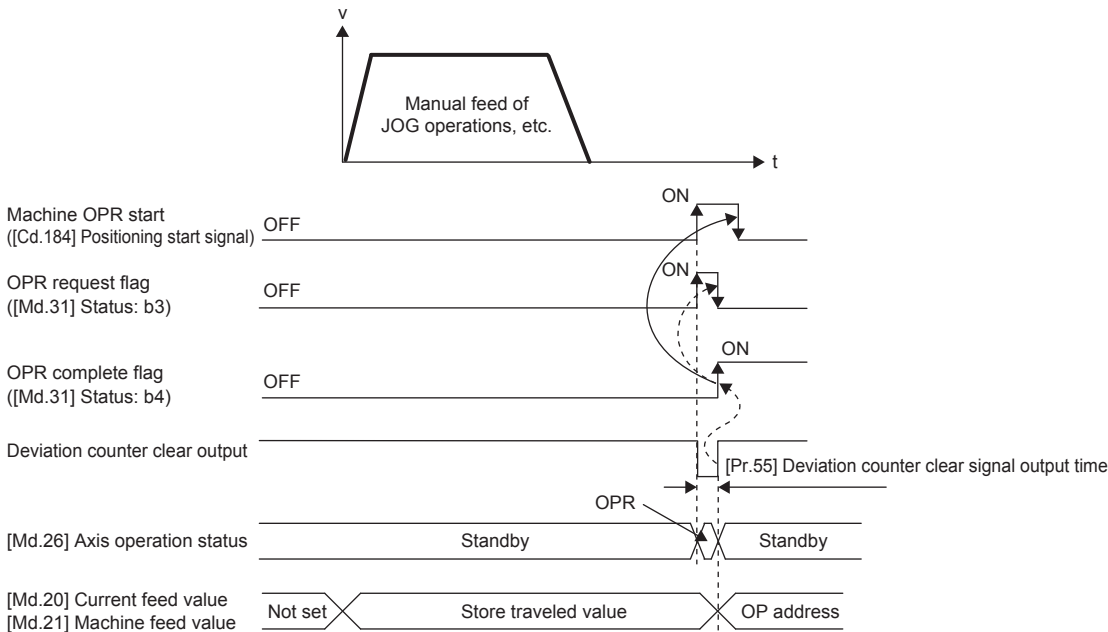

Operation precautions

- If not using the OP shift function, the OPR parameter areas ([Pr.44] to [Pr.57]) other than "[Pr.45] OP address" and "[Pr.55] Deviation counter clear signal output time" are not used for the data setting method. If a value outside the settings range is set, however, an error occurs when "[Cd.190] PLC READY signal" is turned ON, and the READY signal ([Md.140] Module status: b0) does not turn ON. To avoid the an error occurring when "[Cd.190] PLC READY signal" is turned ON, set values within the setting range (or default values) for the unused OPR parameter areas.
- When performing an OPR operation using Data setting method for a device for which the backlash compensation function is used, perform the manual control beforehand. Otherwise the backlash compensation cannot be properly executed.

Limit switch combined-use method

The following shows an operation overview of the "limit switch combined-use method", one of the OPR methods.

Point

For the applicable version of the positioning module adopting the "limit switch combined-use method", one of the OPR methods, refer to Page 561 Added and Enhanced Functions.

Operation chart

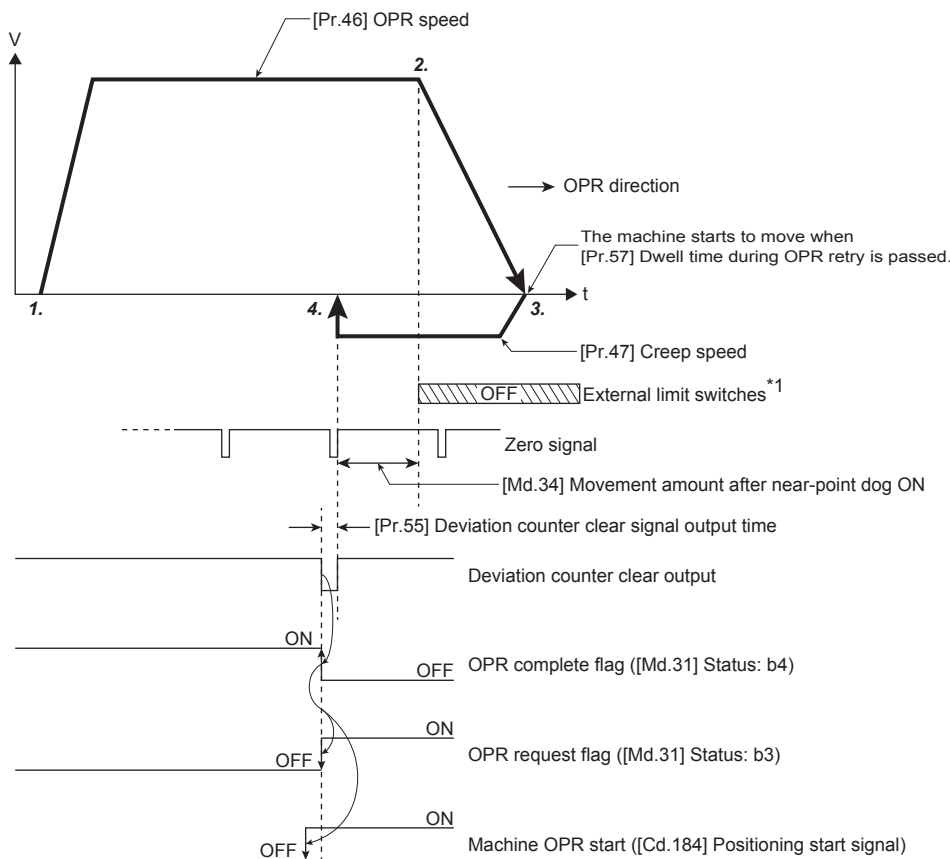

*1 Make sure to use the limit switch as a normally closed contact.

1. The machine OPR is started. (The machine starts accelerating according to the setting of "[Pr.51] OPR acceleration time selection" in the direction specified in "[Pr.44] OPR direction", and moves at the speed set in "[Pr.46] OPR speed" when the acceleration is completed.)
2. When the off state of the limit switch is detected, the machine starts decelerating.
3. When "[Pr.57] Dwell time during OPR retry" is passed after the deceleration stop, the machine moves at the speed set in "[Pr.47] Creep speed" in the direction opposite to the direction set in "[Pr.44] OPR direction".
4. After the limit switch turns on and at the first input of zero signals, the positioning module stops outputting pulses and outputs "Deviation counter clear output" to the drive unit. (The output is performed for the time set in "[Pr.55] Deviation counter clear signal output time".)
5. After the "Deviation counter clear output" finishes, the OPR complete flag ([Md.31] Status: b4) turns OFF→ON, and the OPR request flag ([Md.31] Status: b3) turns ON→OFF.

Precautions during the operation

- If the limit switch in the direction opposite to the OPR direction turns off, the deceleration stop is performed, the OPR is not completed, and Hardware stroke limit (+)/Hardware stroke limit (-) (Error code: 1905H/1907H) will occur.
- When the OPR is performed from the OFF status of the limit switch in the OPR direction, the machine starts moving at the speed set in "[Pr.47] Creep speed" in the direction opposite to the direction set in the OPR direction.
- In the limit switch combined-use method, the OPR retry function cannot be used. However, "[Pr.57] Dwell time during OPR retry" is always valid.
- Since the deceleration stop is performed after the limit switch is turned off, set the limit switch in consideration of the deceleration distance.

8.3 Fast OPR

Operation overview of the fast OPR

Fast OPR operation

After the OP position is established by performing a machine OPR, the positioning control to the OP position is executed without using a near-point dog or zero signal.

The following shows the operation after the fast OPR is started.

1. The fast OPR is started.
2. The positioning control to the OP position established by a machine OPR operation is performed at the speed set in the OPR parameter areas ([Pr.43] to [Pr.57]).
3. The fast OPR is completed.

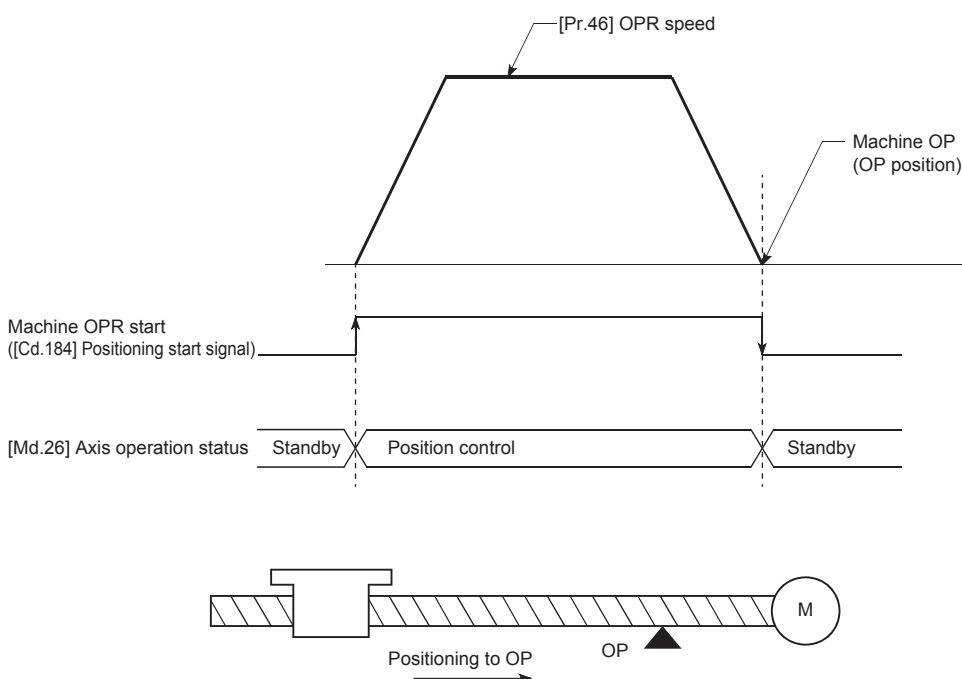

Operation timing and the processing time

The following shows the details on the operation timing and processing time in the fast OPR.

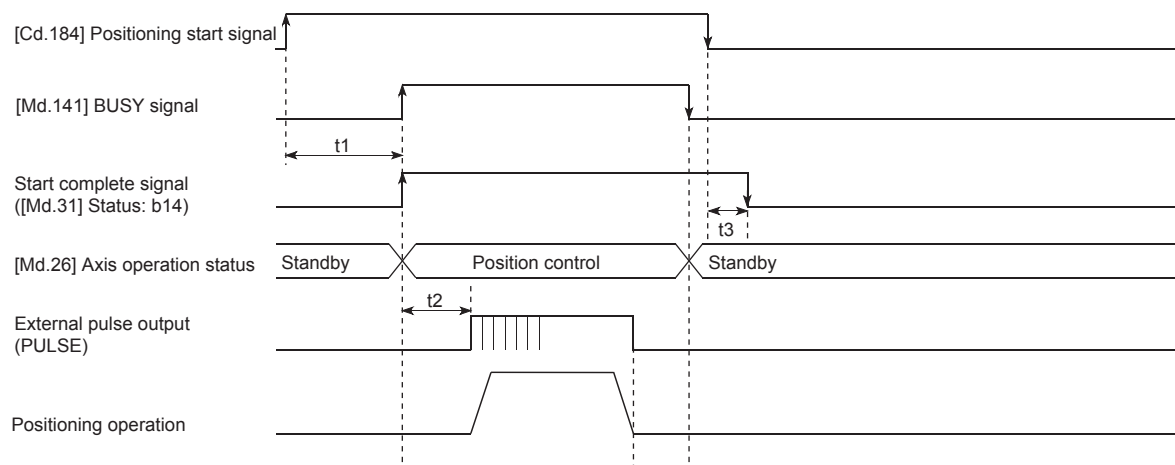

Normal timing time

t1	t2	t3
0.2 to 0.3 ms	0.1 ms or less	0 to 0.88 ms

Precautions during the operation

- The fast OPR can only be implemented after the OP is established by implementing the machine OPR. Otherwise, OPR request ON (Error code: 1945H) occurs. (OPR request flag ([Md.31] Status: b3) must be OFF.)
- If the pulse for the fraction after the decimal point is cleared to 0 by using the current value change or fixed-feed control, executing the fast OPR causes an error equivalent to the cleared pulse.
- When a limitless-feed operation is executed by the speed control and the machine feed value overflows or underflows once, the fast OPR cannot be executed normally.
- OPR complete flag ([Md.31] Status: b4) does not turn ON.
- The axis operation status during the fast OPR is Position control.

9 MAJOR POSITIONING CONTROL

This chapter describes the details and usage of the major positioning control (the control function using positioning data). As the major positioning control, Position control (positioning to the specified position using address information), Speed control (controlling a rotating body at a fixed speed), Speed-position switching control (switching the control type from Speed control to Position control), Position-speed switching control (switching the control type from Position control to Speed control), and others are provided.

Configure the settings required for each control.

9.1 Overview of the Major Positioning Controls

Major positioning controls are implemented using positioning data stored in the positioning module.

The positioning controls, such as the position control and speed control, are implemented by setting the required items in this positioning data and starting that positioning data.

The control method of Major positioning control is set in [Da.2] Control method of the positioning data.

The control defined as Major positioning control performs the following control depending on the setting in [Da.2] Control method.

Major positioning control			[Da.2] Control method	Description
Position control ^{*1}	Linear control	1-axis linear control	ABS linear 1 INC linear 1	Implements positioning control from the start point address (current stop position) to the specified position using the specified one axis.
		2-axis linear interpolation control ^{*1}	ABS linear 2 INC linear 2	Implements linear interpolation control from the start point address (current stop position) to the specified position using the specified two axes.
	Fixed-feed control	1-axis fixed-feed control	Fixed-feed 1	Implements positioning control from the start point address (current stop position) using the specified one axis. ([Md.20] Current feed value is set to 0 at the start.)
		2-axis fixed-feed control ^{*1}	Fixed-feed 2	Implements linear interpolation control from the start point address (current stop position) using the specified two axes. ([Md.20] Current feed value is set to 0 at the start.)
	2-axis circular interpolation control ^{*1}	Sub point specification	ABS circular sub INC circular sub	Implements positioning control in an arc path from the start point address (current stop position) to the specified position using the specified two axes.
		Center point specification	ABS circular right ABS circular left INC circular right INC circular left	
Speed control ^{*1}	1-axis speed control	Forward run speed 1 Reverse run speed 1	Performs the speed control of the specified one axis.	
		Forward run speed 2 Reverse run speed 2	Performs the speed control of the specified two axes.	
Speed-position switching control			Forward run speed-position Reverse run speed-position	Implement speed control, and then position control (Positioning with the specified address or movement amount) immediately after that by turning on the speed-position switching signal.
Position-speed switching control			Forward run position-speed Reverse run position-speed	Performs the position control, and then speed control immediately after that by turning on Position-speed switching signal.

Major positioning control		[Da.2] Control method	Description
Other controls	NOP instruction	NOP instruction	A control method that is not implemented. When the NOP instruction is set, the operation of the next data starts and this instruction is not implemented.
	Current value change	Current value change	Changes the value in "[Md.20] Current feed value" to the address set in the positioning data. The following two methods can be used. (Machine feed value cannot be changed.) • Current value change using the control method • Current value change using the start No. for a current value change (No. 9003)
	JUMP instruction	JUMP instruction	Unconditionally or conditionally jumps to the specified positioning data No.
	LOOP	LOOP	Implements repetition control with the LOOP to LEND instructions.
	LEND	LEND	Returns to the beginning of the repetition control with LOOP to LEND instructions. When the repetition of the instructions has been completed for the specified number of times, the operation of the next positioning data starts.

*1 "2-axis linear interpolation control", "2-axis fixed-feed control", "2-axis circular interpolation control", and "2-axis speed control" use the motor set in the direction of the two axes to implement control to describe linear or circular paths.
This type of control is called interpolation control. (☞ Page 117 Interpolation control)

Data required for major positioning control

The following table lists Positioning data required for performing Major positioning control.

Setting item			Setting detail
Positioning data	[Da.1]	Operation pattern	Set an operation pattern for the continuous positioning data (example: Positioning data No.1 to 3). (☞ Page 104 Operation pattern of major positioning control)
	[Da.2]	Control method	Set a control method defined for Major positioning control used. (☞ Page 102 Overview of the Major Positioning Controls)
	[Da.3]	Acceleration time No.	Select and set an acceleration time at the start of the control. (Select one from four values set in [Pr.9], [Pr.25], [Pr.26], and [Pr.27] as the acceleration time.)
	[Da.4]	Deceleration time No.	Select and set a deceleration time at the stop of the control. (Select one from four values set in [Pr.10], [Pr.28], [Pr.29], and [Pr.30] as the deceleration time.)
	[Da.5]	Axis to be interpolated	Set a target axis (partner axis) for the 2-axis interpolation control. (☞ Page 117 Interpolation control)
	[Da.6]	Positioning address/movement amount	Set a target value for the position control. (☞ Page 111 Specifying the positioning address)
	[Da.7]	Arc address	Set a sub point or a center point address for the circular interpolation control.
	[Da.8]	Command speed	Set the speed at the execution of the control.
	[Da.9]	Dwell time	The time from when the command pulse output is completed to when Positioning complete signal is turned on. Set this time to absorb the delay of machine systems to the command, such as the delay (deviation) of the servo system.
	[Da.10]	M code	Set an M code to issue a command for a subsidiary work (such as stopping clamps or drills and changing tools) corresponding to each M code number that can be related to the implementation of the positioning data.
	[Da.27]	M code ON signal output timing	Set the M code ON signal output timing for each positioning data.
	[Da.28]	ABS direction in degrees	Set the ABS direction in degrees for each positioning data.
[Da.29]	Interpolation speed specification method	Set the interpolation speed specification method for each positioning data.	

The settings of [Da.1] to [Da.10] and [Da.27] to [Da.29] depend on the setting of [Da.2] Control method. (☞ Page 121 Positioning Data Settings)

Sub functions for major positioning control

For details on the sub functions that can be combined with the major positioning control, refer to the following.

☞ Page 34 Combining Main and Sub Functions

For details on each sub function, refer to the following.

☞ Page 218 CONTROL SUB FUNCTION

Major positioning control from GX Works3

"Major positioning control" can be implemented using the GX Works3 positioning test. For details on the positioning test, refer to the following.

📖 Page 340 Positioning Test

Point

600 positioning data max. (Positioning data No.1 to 600) can be set for each axis.

Operation pattern of major positioning control

In "Major positioning control" ("Advanced positioning control"), "[Da.1] Operation pattern" can be set to specify whether to continue implementing positioning data after the started positioning data. Operation pattern can be classified into the following three patterns.

Positioning control	Operation pattern
Positioning Complete	Independent positioning control (operation pattern: 00)
Positioning continue	Continuous positioning control (operation pattern: 01)
	Continuous path control (operation pattern: 11)

Independent positioning control (positioning complete)

Set this pattern when executing the positioning of only one specified data. If a dwell time is specified, the positioning will be completed when the specified time elapses.

For the block positioning, this data (operation pattern: 00) is the end of the data. (The positioning stops after this data is implemented.)

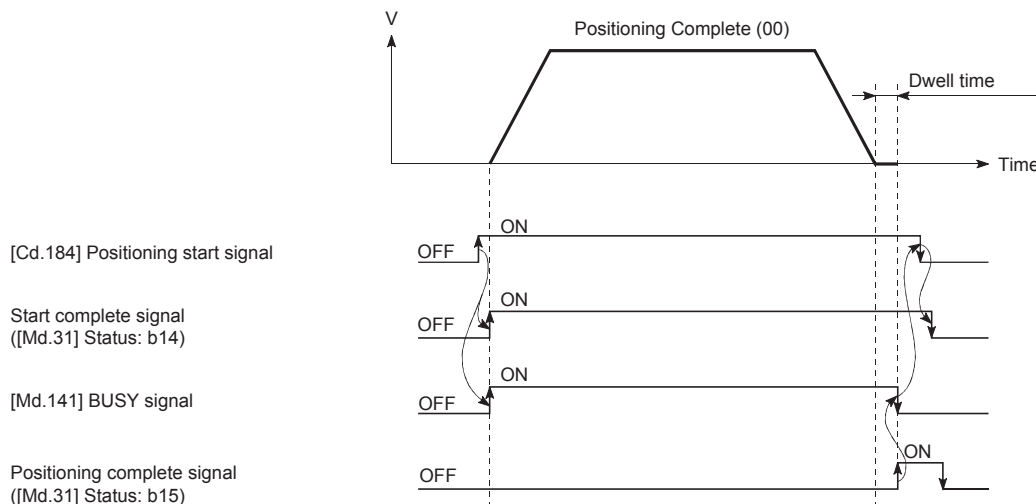

Continuous positioning control

- Make sure to auto decelerate each time the positioning for one positioning data finishes, and accelerate to implement the next positioning data operation after the designated speed of the positioning module reaches zero. If a dwell time is specified, the acceleration is performed after the specified time elapses.
- In the operation by the continuous positioning control (operation pattern: 01), the positioning of the next positioning No. is automatically implemented. Always set Operation pattern: 00 to the last positioning data to complete the positioning. If the operation pattern is Positioning continue (01 or 11), the operation continues until Operation pattern: 00 is found. Consequently, if Positioning complete ("00") is not found in the operations pattern, operations are implemented until positioning data No. 600, and if the positioning data No. 600 operation pattern is not positioning complete, operations are implemented again from Positioning data No. 1.

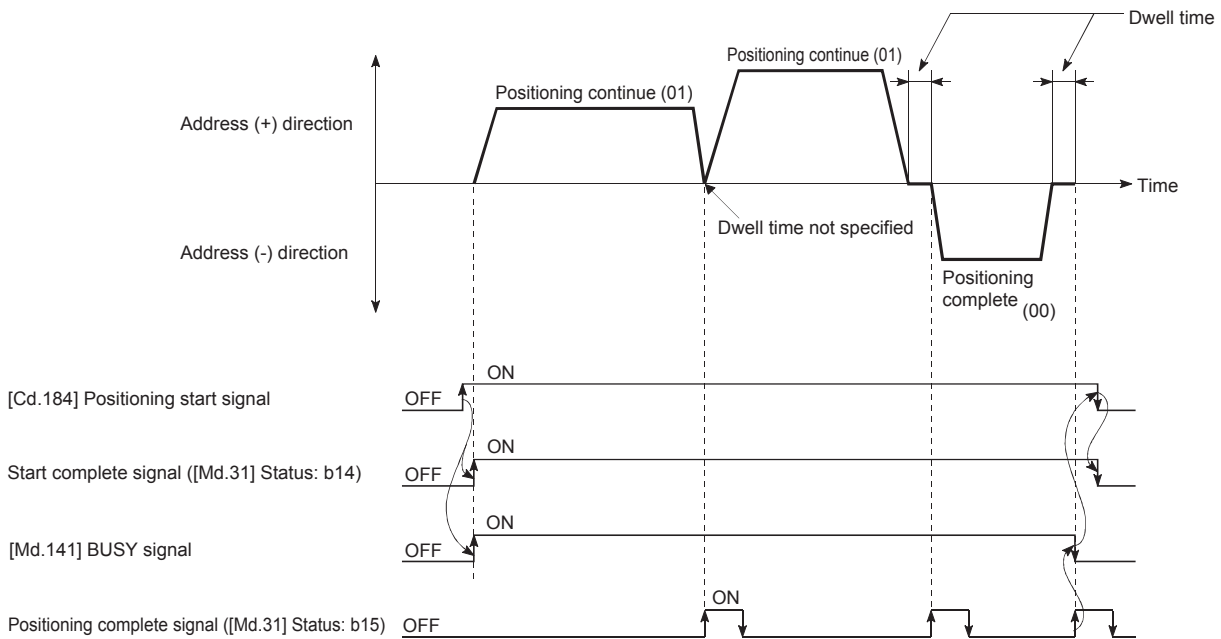

Continuous path control

■ Continuous path control

- The speed changes without the deceleration stop from the command speed of the positioning data No. currently being executed to the speed of the next positioning data No. When the current speed is equal to the next speed, the speed does not change.

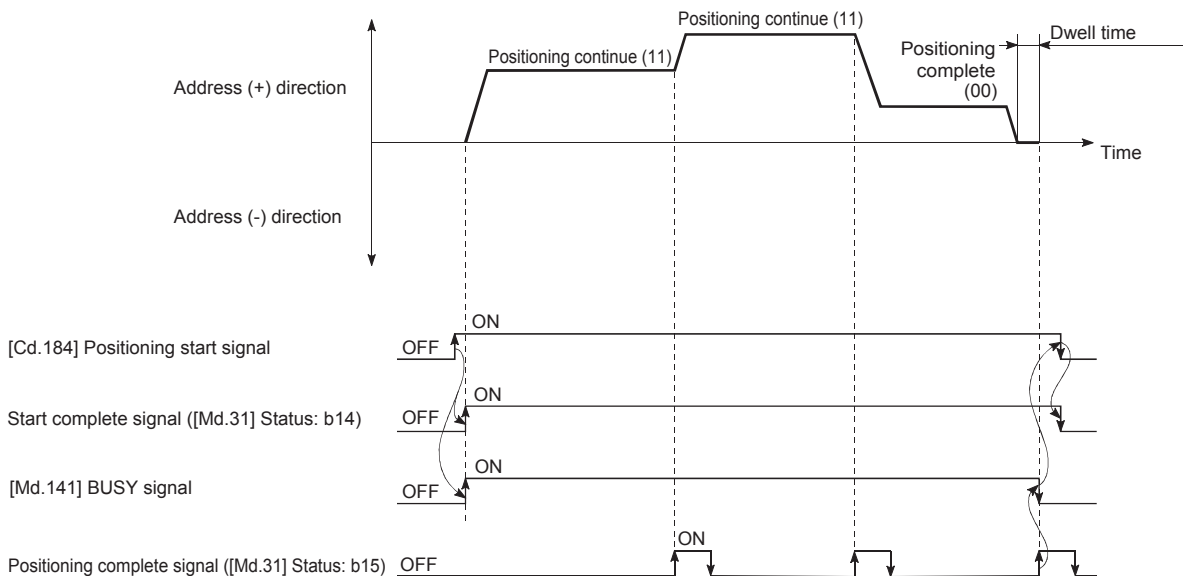

- When the command speed is set to -1, the speed used in the previous positioning operation is used.
- The dwell time is ignored even if it is set.

- In the operation by the continuous path control (operation pattern: 11), the positioning of the next positioning No. is automatically implemented. Always set Operation pattern: 00 to the last positioning data to complete the positioning. If the operation pattern is Positioning continue (01 or 11), the operation continues until Operation pattern: 00 is found. Consequently, if positioning in the operations pattern is not finished, operations are implemented until positioning data No. 600, and if the operations pattern for positioning data No. 600 is not positioning complete, operations are implemented again from positioning data No. 1.
- The speed switching is classified into two modes: the front-loading speed switching mode in which the speed is changed at the end of the current positioning side and the standard speed switching mode in which the speed is changed at the start of the next positioning side. (☞ Page 400 [Pr.19] Speed switching mode)
- In the continuous path control, the positioning may be completed before the set address/movement amount by the distance Δd , and the data to be controlled may be switched to the next positioning data No. The range of the value of the distance Δd is as follows.

$0 \leq \Delta d < (\text{Moving distance in } 0.88 \text{ ms at the command speed})$

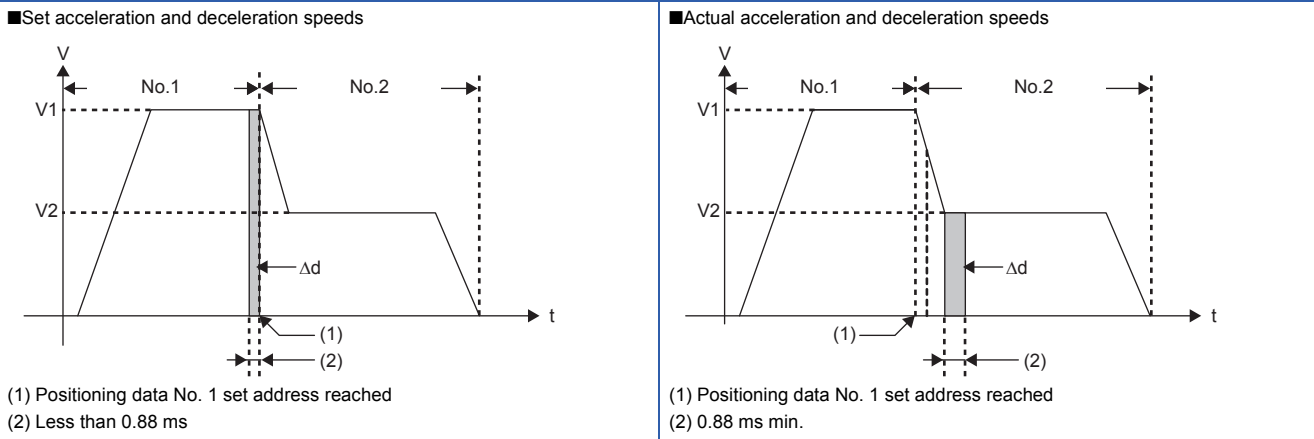

The distance Δd is output when the next positioning data No. is executed at the constant speed. Therefore, the execution time of the next positioning data may be extended longer than the set execution time of the positioning control^{*1}. If the extension of the execution time is a problem, perform the following actions.

Corrective action	Description
Use the near pass control output timing selection function.	By setting the output timing to At deceleration, the execution time of the next positioning is equivalent to the set execution time of the positioning control. (☞ Page 235 Output timing selection of near pass control)
Use the speed change function.	Change the speed using the speed change function instead of the continuous path control. (☞ Page 237 Speed limit function)

*1 For the continuous path control, when the command speed V1 of the positioning data and the command speed V2 of the next positioning data is different significantly, and $V1 > V2$

For the positioning data in which the automatic deceleration is performed, the positioning is completed at the set address. Consequently, the positioning data completion address using continuous path control may differ from the set address, but this will become the address as set when auto deceleration using either continuous positioning control (01) or positioning finished (00) is complete.

Point In the continuous path control, the speed is not changed when the positioning data No. is switched by the near pass function. (☞ Page 233 Near pass function)

■Conditions of deceleration stop during the continuous path control

The deceleration stop is not performed in the continuous path control. However, in the following three cases, the deceleration stop is performed and the speed becomes 0 once.

- When the operation pattern of the positioning data currently being implemented is Continuous path control: 11 and the movement direction of the positioning data currently being implemented differs from that of the next positioning data. (Only for the positioning control of one axis. (See point))

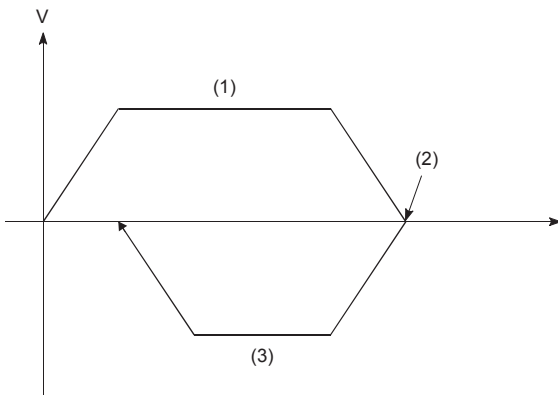

- (1) Positioning data No. 1 (Operations pattern: 11)
- (2) Speed is 0
- (3) Positioning data No. 2 (Operations pattern: 00)

- During the operation with the step operation. (☞ Page 280 Step function)
- If an error occurs in the positioning data for the next operation. Sudden stop may occur due to an error. (☞ Page 73 Stopping)

Point

- In the positioning data of the continuous path control, the command speed becomes 0 for about 0.88 ms when [Da.6] Positioning address/movement amount is set to 0. If [Da.6] Positioning address/movement amount is set to 0 to increase the number of speed change points in the future, change the setting of [Da.2] Control method to NOP instruction not to execute the positioning data No. (☞ Page 169 NOP instruction)
- In the positioning data of the continuous path control, ensure the movement amount so that the execution time of the data becomes 100 ms or longer, or reduce the command speed.

■Operation for sudden direction reversal

- The movement direction is not checked during the interpolation control. Thus, the deceleration stop is not performed even if the movement direction is changed. Therefore, the interpolation axis may suddenly reverse its direction. To avoid the sudden direction reversal, set Continuous positioning control: 01 for the positioning data at the passing point instead of Continuous path control: 11.

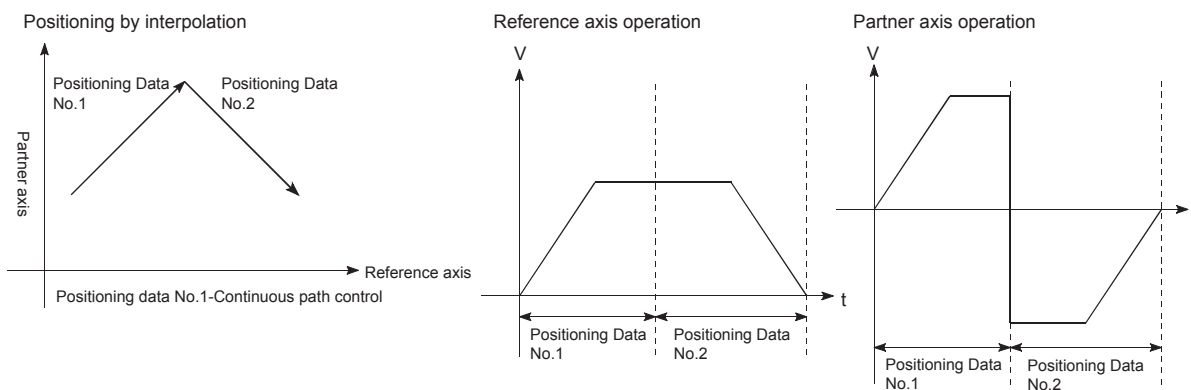

- When the interpolation axis suddenly reverses its direction, the command pulses from the positioning module are output as described below.

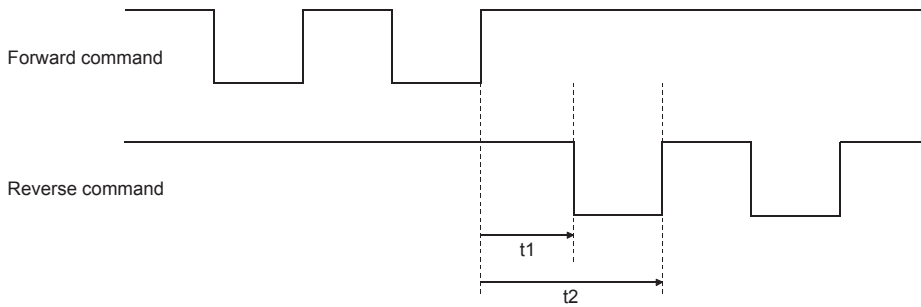

When a command frequency is f (pulse/s), t_1 and t_2 are determined using the following calculation formulas.

- $t_1 = 1/2f[s]$
- $t_2 = 1/f[s]$

A time of t_1 must be ensured by the drive unit for a specified time $T[s]$ or longer. (The time T depends on the specifications of the drive unit.)

When the time of t_1 cannot be ensured for T or longer, reduce the value in [Da.8] Command speed of the positioning data.

Speed handling

- The command speed of the continuous path control is set for each positioning data. The positioning module implements positioning at the speed specified with each positioning data.
- The command speed can be set to -1 in the continuous path control. When the command speed is set to -1, the control is performed at the speed used in the previous positioning data No. (When the positioning data is set using GX Works3, the current speed is displayed in the command speed of the GX Works3. Current speed is the speed of the positioning control currently being implemented.)
- If the command speed has been set to -1 before the uniform speed control is executed, the speed does not need to be set in each positioning data.
- If the speed is changed or the override function is executed in the previous positioning data when the command speed has been set to -1, the control can be continued at the new speed.
- If -1 is set in the command speed of the first positioning data at the start, No command speed (Error code: 1A12H) occurs and the positioning cannot be started.

[Relation between the command speed and current speed]

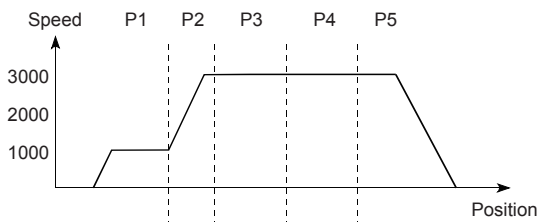

[Da. 8] Command speed	1000	3000	-1	-1	-1
[Md.27] Current speed	1000	3000	3000	3000	3000

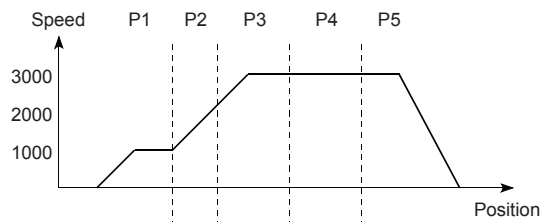

[Da. 8] Command speed	1000	3000	-1	-1	-1
[Md.27] Current speed	1000	3000	3000	3000	3000

Current speed is changed even if the command speed is not reached using P2.

- In the continuous path control, the speed is not changed when the positioning data No. is switched by the near pass function. (☞ Page 233 Near pass function)
- The positioning module holds the command speed set with the positioning data and the latest speed value set with the speed change request as [Md.27] Current speed to control with the current speed when -1 is set for the command speed. (Depending on the relation between the movement amount and the speed, the feed rate may not reach the command speed, but even so, the current speed will be updated.)
- When the address for the speed change is identified beforehand, create and execute the positioning data for the speed change with the continuous path control to perform the speed change without requesting the speed change using a program.

Speed switching (Refer to "[Pr.19] Speed switching mode")

The following two modes are provided to change the speed.

Speed switching mode	Description
Standard switching	Switches the speed when executing the next positioning data.
Front-loading switching	Switches the speed at the end of the positioning data currently being executed.

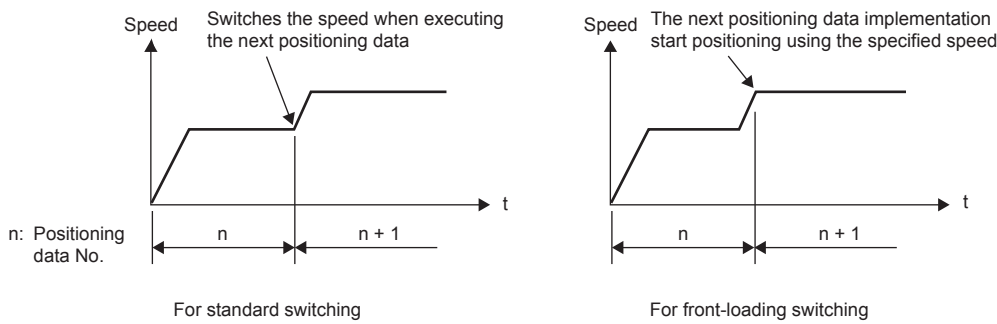

Standard speed switching mode

- If the command speed of the positioning data currently being executed and that of the next positioning data differ, the machine will accelerate or decelerate after reaching the positioning point set in the positioning data currently being executed, and the speed will change over to the speed set in the next positioning data.
- The parameters used in the acceleration/deceleration processing to the command speed set in the next positioning data to be executed are those of the next positioning data to be executed. If the command speeds are the same, the speed changed will not be performed.

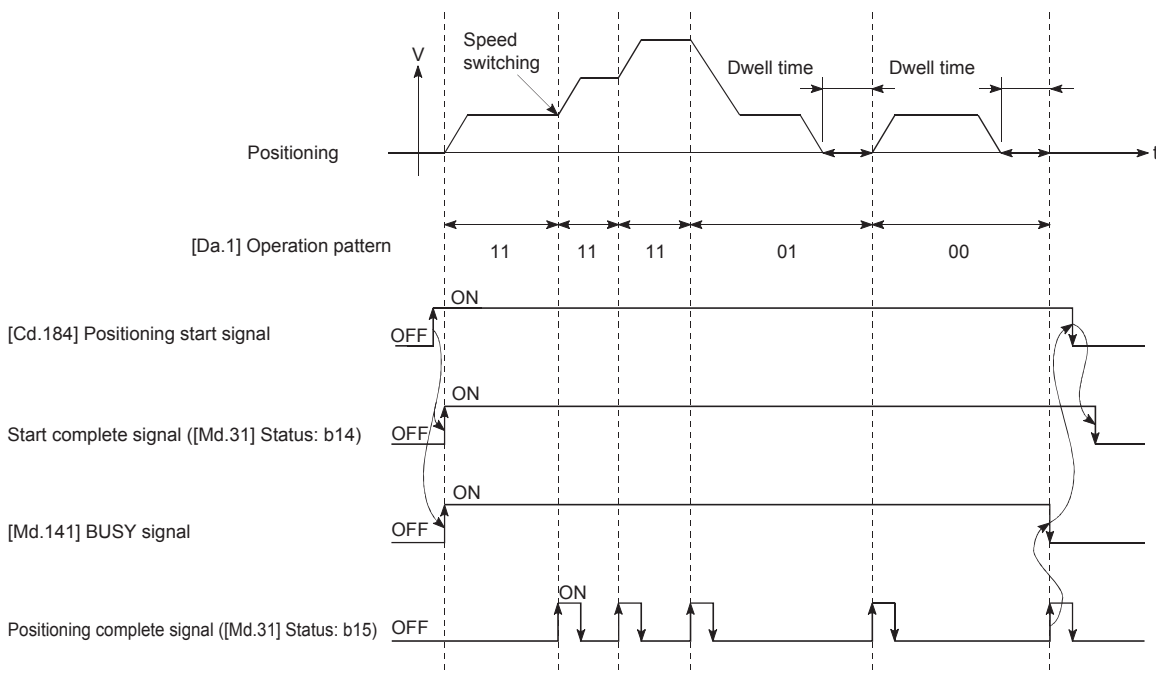

- Speed switching condition

If the movement amount is small relative to the target speed and the target speed is not reached even if the acceleration/ deceleration is performed, the machine is accelerated or decelerated to get close to the target speed. If the movement amount is exceeded when automatic deceleration needs to be performed (such as when the operation pattern is 00 or 01), the machine will immediately stop at the specified positioning address, and Insufficient movement amount (Warning code: 0998H) OCCURS.

■When the speed cannot be changed in P2
When the relation of the speeds is $P1 = P4, P2 = P3, P1 < P2$

■When the movement amount is small during the automatic deceleration
As the movement amount required to perform the automatic deceleration cannot be secured, the machine immediately stops with speed status $\neq 0$.

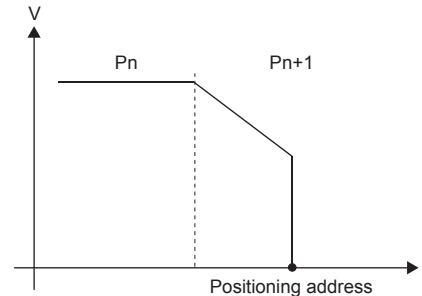
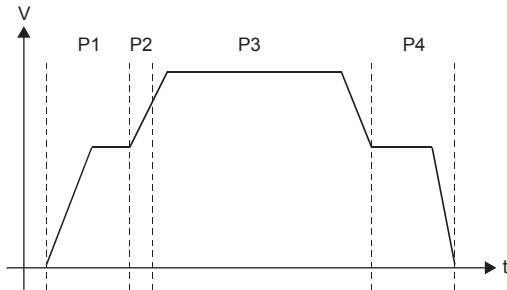

■Front-loading speed switching mode

- If the command speed of the positioning data currently being implemented and that of the next positioning data differ, the speed will switch to reach the speed set in the next positioning data at the end of the positioning data currently being implemented.
- The parameters used in the acceleration/deceleration processing to the command speed set in the next positioning data to be implemented are those of the next positioning data to be implemented. If the command speeds are the same, the speed changed will not be performed.

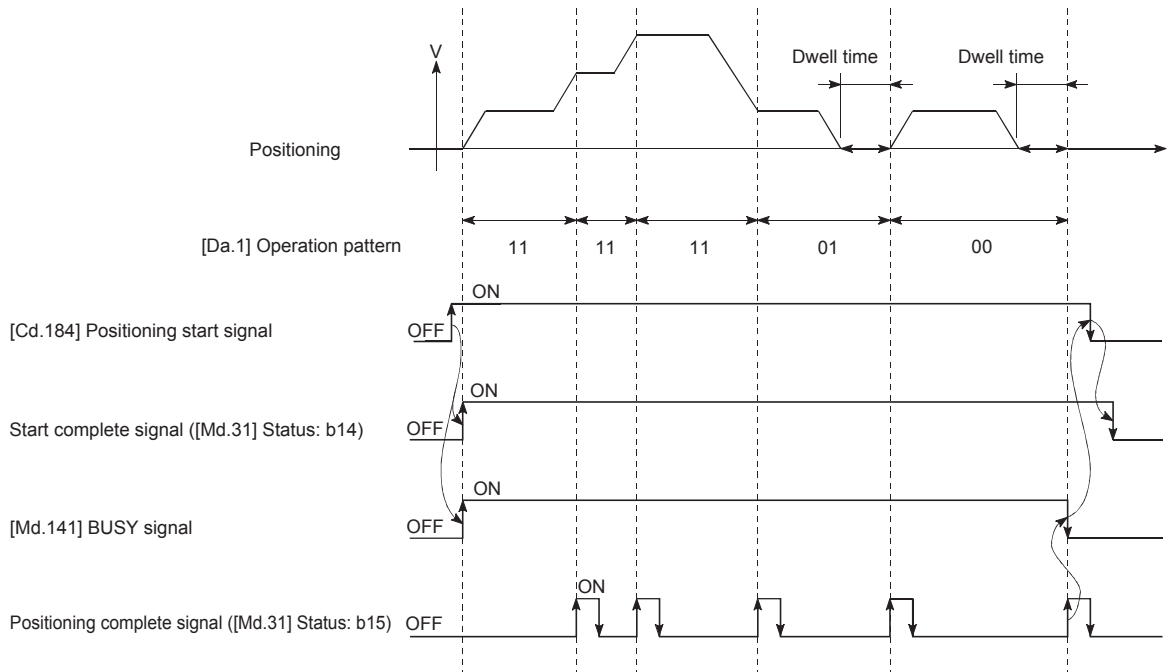

• Speed switching condition

If the movement amount is small relative to the target speed and the target speed is not reached even if the acceleration/ deceleration is performed, the machine is accelerated or decelerated to get close to the target speed. If the movement amount will be exceeded when the automatic deceleration needs to be performed (such as when the operation pattern is 00 or 01), the machine will immediately stop at the specified positioning address, and Insufficient movement amount (Warning code: 0998H) occurs.

■ When the speed cannot be changed to the P2 speed in P1
When the relation of the speeds is $P1 = P4, P2 = P3, P1 < P2$

■ When the movement amount is small during the automatic deceleration
As the movement amount required to perform the automatic deceleration cannot be secured, the machine immediately stops with speed status $\neq 0$.

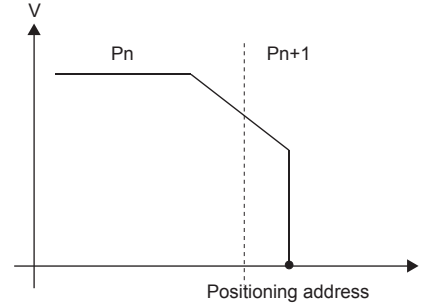
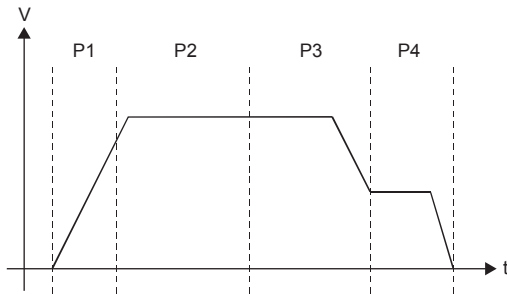

Specifying the positioning address

One of the following two methods can be used for commanding the position in the control using positioning data.

Absolute system

The positioning is performed to a specified position (absolute address) having the OP as a reference. The specified address is used as the positioning address. (Any address can be set as the start point.)

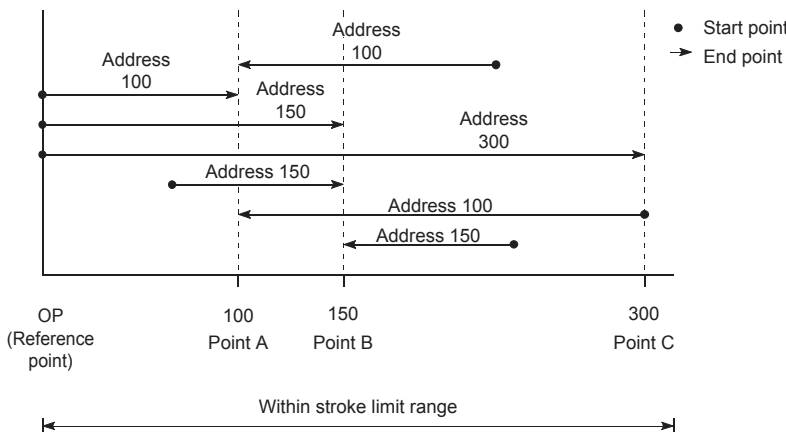

Incremental system

The position where the machine is currently stopped is regarded as the start point, and the positioning is performed for a specified movement amount in a specified movement direction.

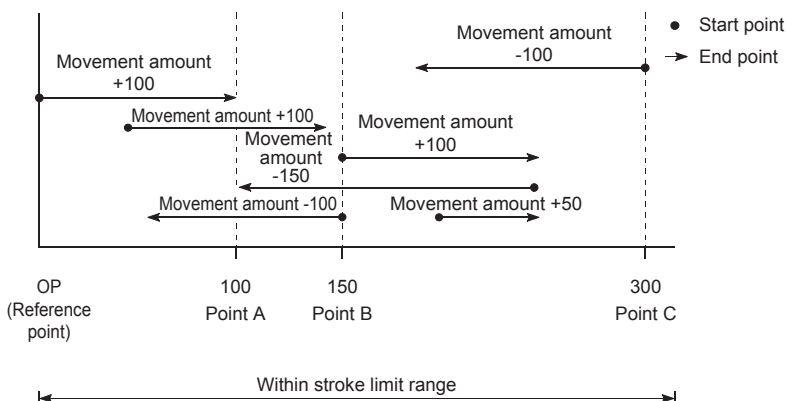

Checking the current value

Values indicating the current values

The positioning module uses 2 types of address as described below as the positioning values.

These addresses (Current feed value and Machine feed value) are stored in the monitor data area, and used for monitoring the current value display.

Item	Description
Current feed value	<ul style="list-style-type: none"> The value stored in [Md.20] Current feed value. This value has an address established with Machine OPR as a reference. However, the address can be changed by changing the current value. This value is updated every 0.88 ms.
Machine feed value	<ul style="list-style-type: none"> The value stored in [Md.21] Machine feed value. This value always has an address established with Machine OPR as a reference. The address cannot be changed even if the current value is changed to a new value. This value is updated every 0.88 ms.

Current feed value and Machine feed value are used for monitoring the current value display.

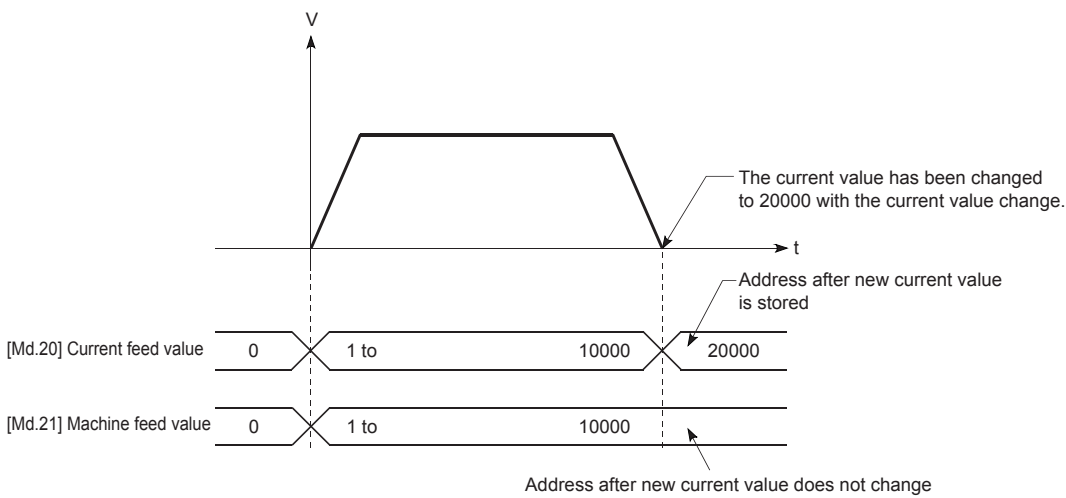

Restrictions

When the stored Current feed value is used for the control, an error of 0.88 ms will occur in the update timing of the current value. When the stored Machine feed value is used for the control, an error of 0.88 ms will occur in the update timing of the current value.

Monitoring the current value

Current feed value and Machine feed value are stored in the following buffer memory areas, and can be read using a DFROM (P) instruction or DMOV (P) instruction from the CPU module.

	Buffer memory address	
	Axis 1	Axis 2
[Md.20] Current feed value	800, 801	900, 901
[Md.21] Machine feed value	802, 803	902, 903

Program example

The following shows an example of the program that stores the current feed value of the axis 1 in the specified device.



Classification	Label Name	Description	
Module label	FX5PG_1.stnAxisMonitorData_Axis_D[0].dCurrentFeedValue_D	Axis 1: Current feed value	
Global label, local label	Define the global label or local label as follows. Setting Assign (Device/Label) for labels is not necessary because the unused internal relay and data device are automatically assigned to the labels.		
	Label Name	Data Type	Class
	1 bCurrentFeedValueReadReq	Bit	... VAR
	2 dCurrentFeedValue	Double Word [Signed]	... VAR

Handling degree (control unit)

If degree is set as the control unit, the following items differ from the ones for when other control units are set.

Addresses of Current feed value and Machine feed value

The address of "[Md.20] Current feed value" is a ring address from 0° to 359.99999° . However, the address of [Md.21] Machine feed value does not become a ring address.

■ Current feed value

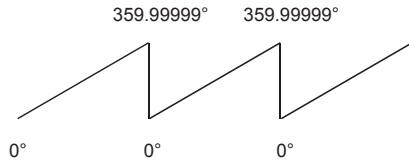

■ Machine feed value

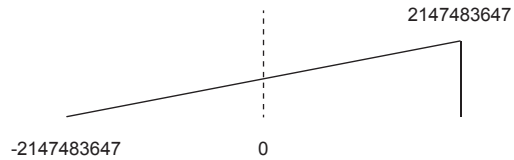

Software stroke limit valid/invalid setting

When the control unit is degree, the upper/lower limit values of the software stroke limit are 0° to 359.99999° .

■ Setting to validate the software stroke limit

To validate the software stroke limit, set the lower limit value and upper limit value of the software stroke limit in a clockwise rotation.

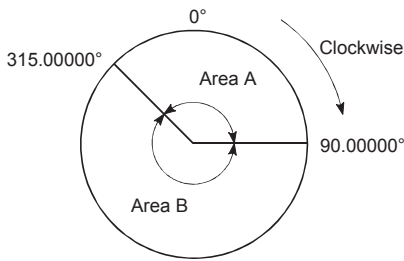

Implement the following to set the travel range for each section.

(1) Implement the following to set the travel range for area A.

- Software stroke lower limit value: 315.00000°
- Software stroke upper limit value: 90.00000°

(2) Implement the following to set the travel range for area B.

- Software stroke lower limit value: 90.00000°
- Software stroke upper limit value: 315.00000°

■ Setting to invalidate the software stroke limit

To invalidate the software stroke limit, set the software stroke lower limit value equal to the software stroke upper limit value.

The control can be performed regardless of the setting of the software stroke limit.

Positioning control method when degree is set as the control unit

■When the absolute system is used

■If the software stroke limit is invalid

The positioning is performed in the direction nearest to the specified address, using the current value as a reference. (This control is called shortcut control.)

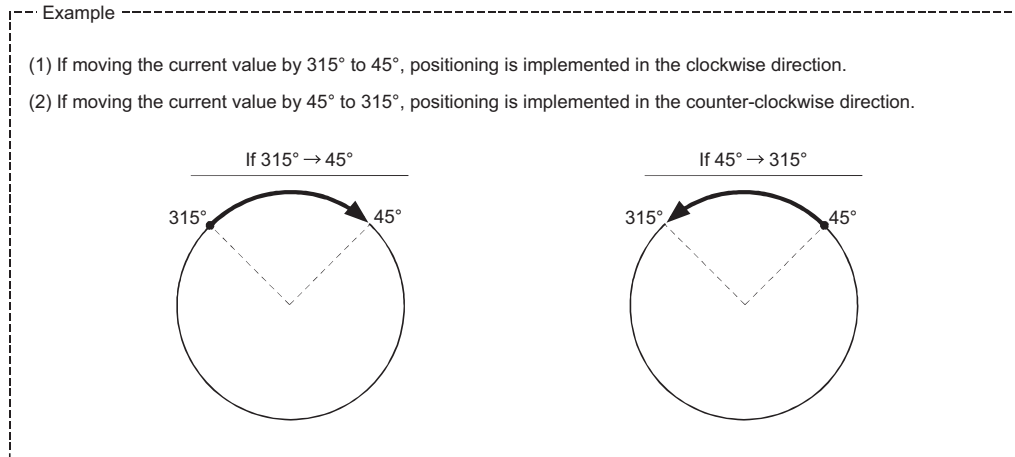

When the rotation angle is 180°, the rotation direction is determined depending on the start point position.

Start point position	Rotation direction
$0^\circ \leq \text{Start point} < 180^\circ$	Clockwise
$180^\circ \leq \text{Start point} < 360^\circ$	Counterclockwise

(1) If specifying the positioning direction (If shortcut control is not implemented)

Disable shortcut control using either "[Cd.40] ABS direction in degrees" or "[Da.28] ABS direction in degrees" to enable positioning in the specified direction.

This function can be implemented when the software stroke limit is disabled. When the software stroke limit is enabled, the ABS direction in degree setting (Error code: 19A5H) is illegal, and positioning is not started.

With "[Cd.40] ABS direction in degrees" or "[Da.28] ABS direction in degrees", the set value of the reference axis is applied to the reference axis and interpolation axis. Even if a unit other than degree is set for the reference axis, the setting of the reference axis is applied to the interpolation axis as described below (for the 2-axis linear interpolation control (ABS2)).

Axis	Unit setting	"[Cd.40] ABS direction in degrees"	Rotation direction in degrees
Reference axis	pulse	1: ABS clockwise	—
Interpolation axis 1	degree	—	1: ABS clockwise

(2) If specifying the rotation direction in degrees for each positioning data

To specify the rotation direction in degrees for each positioning data, especially for the continuous positioning control and continuous path control, use "[Da.28] ABS direction in degrees".

(3) If setting the same rotation direction using all positioning data

- The rotation direction of all positioning data can be specified en block by setting "[Cd.40] ABS direction in degrees".
- If using "[Cd.40] ABS direction in degrees", set "0: Use the setting value in [Cd.40] ABS direction in degrees" in "[Da.28] ABS direction in degrees". When a value other than 0 is set, "[Da.28] ABS direction in degrees" is enabled.

- The setting value in "[Cd.40] ABS direction in degrees" is valid only at the start of positioning control. In the continuous positioning control or continuous path control, the operation continues with the setting configured at the start even if the setting is changed during the operation.

Setting item	Setting detail	Buffer memory address		Initial value
		Axis 1	Axis 2	
[Cd.40] ABS direction in degrees	Specify the ABS movement direction in increments of degrees. <ul style="list-style-type: none"> • 0: Shortcut (Direction setting invalid) • 1: ABS clockwise • 2: ABS counterclockwise 	1550	1650	0
[Da.28] ABS direction in degrees	Set "[Cd.40] ABS direction in degrees" for each positioning data. <ul style="list-style-type: none"> • 0: Use the set value of "[Cd.40] ABS direction in degrees". • 1: ABS clockwise • 2: ABS counterclockwise • 3: Shortcut (Direction setting invalid) 	2003+N*1 (b2 to b3)	8003+N*1 (b2 to b3)	0

*1 N indicates the offset address of each positioning data.
 $N = ((\text{Positioning data No.}) - 1) \times 10$

■ When the software stroke limit is valid

The positioning is performed in a clockwise or counterclockwise direction depending on the setting method of the software stroke limit range.

Consequently, positioning with the shortcut control may not be possible.

[Example]

If traveling to 315° using current value 0°, positioning is implemented using clockwise rotations if the software stroke lower limit value is 0° and the upper limit value is 345°.

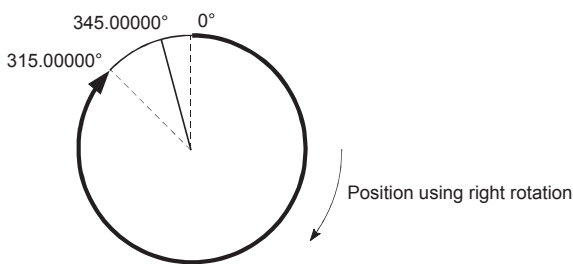

Point

The range of positioning addresses is 0° to 359.99999°.

To implement positioning of one rotation or more, use the incremental system.

■ When the incremental system is used

The positioning is performed for a specified movement amount in a specified direction. The movement direction is determined by the sign of the movement amount.

- When the movement direction is positive: Clockwise
- When the movement direction is negative: Counterclockwise

Point

The positioning of 360° or more can be performed with the incremental system.

In this case, invalidate the software stroke limit by setting values as follows. (Set a value within the setting range of 0° to 359.99999°.)

[Software stroke limit upper limit value = Software stroke limit lower limit value]

Interpolation control

Meaning of the interpolation control

With "2-axis linear interpolation control", "2-axis fixed feed control", "2-axis speed control", and "2-axis circular interpolation control", the motors set in the 2 axis directions are used to control so that the designated path is described. This type of control is called interpolation control.

In the interpolation control, the axis in which the control method is set is defined as the reference axis and the other axes are defined as the interpolation axes. The positioning module controls the reference axis following the positioning data set in the reference axis, and controls of the interpolation axes corresponding to the control of the reference axis so that a linear or arc path is drawn.

The following table shows the combinations of the reference axis and interpolation axes.

Interpolation control set in [Da.2] Control method	Reference axis	Interpolation axis
2-axis linear interpolation control, 2-axis fixed-feed control, 2-axis circular interpolation control, and 2-axis speed control	Either axis 1 or 2	Depends on the axis to be interpolated set in the reference axis

Positioning Data Settings

When the interpolation control is performed, the same positioning data No. are set for the reference axis and interpolation axis. The following table shows the setting items of Positioning data of the reference axis and interpolation axis.

◎: Always set, ○: Set as required, △: Setting restricted

—: Setting not required (Because this item is an irrelevant item, the set value is ignored. Set the value within the setting range, such as the initial value.)

Setting item	Setting item of reference axis	Setting item of interpolation axis	
Same positioning data No.	[Da.1] Operation pattern	◎	
	[Da.2] Control method	◎ Line 2 Fixed-feed 2 Circular sub, circular right, circular left Forward run speed 2 Reverse run speed 2	
	[Da.3] Acceleration time No.	◎	
	[Da.4] Deceleration time No.	◎	
	[Da.5] Axis to be interpolated	○*1	
	[Da.6] Positioning address/movement amount	○ Not required for forward run speed 2 or reverse run speed 2	△ Not required for forward run speed 2 or reverse run speed 2
	[Da.7] Arc address	△ For circular sub, circular right, circular left only	△ For circular sub, circular right, circular left only
	[Da.8] Command speed	◎	△ Required for forward run speed 2 and reverse run speed 2
	[Da.9] Dwell time	○	—
	[Da.10] M code	○	◎
	[Da.27] M code ON signal output timing	○	—
	[Da.28] ABS direction in degrees	○	—
	[Da.29] Interpolation speed specification method	○	—

*1 The partner axis is set for the axis interpolation. If the self-axis is set, illegal interpolation description command (Error code: 1A22H) occurs.

For details on the settings, refer to the following.

 Page 423 Positioning Data

Starting the interpolation control

To start the interpolation control, the positioning data No. of the reference axis (the axis for which the interpolation control was set in [Da.2] Control method) are started. (Starting of the interpolation axis is not required.)

If both the reference axis and interpolation axis are started, the following errors or warning will occur and the positioning will not start.

- Reference axis: Interpolation while partner axis BUSY (Error code: 1998H)
- Interpolation axis: Control method setting error (Error code: 1A24H), Start during operation (Warning code: 0900H)

Interpolation control continuous positioning

To perform the interpolation control in which Continuous positioning control and Continuous path control are specified in the operation pattern, the positioning method for all the positioning data from the started positioning data to the positioning data in which Positioning complete is set must be set to the interpolation control.

The number of interpolation axes and axes to be interpolated cannot be changed from the intermediate positioning data. If the number of interpolation axes and axes to be interpolated are changed, Control method setting error (Error code: 1A25H) occurs and the positioning will stop.

Precautions

- If using a stepping motor, circular interpolation control is disabled. Use a servomotor to implement circular interpolation control.
- If any axis exceeds the value in [Pr.8] Speed limit value during 2-axis speed control, the axis exceeding the speed limit value is controlled using the speed limit value. The speeds of the other axes being interpolated are suppressed by the command speed ratio.
- During 2-axis linear interpolation control, 2-axis fixed feed control, or 2-axis circular interpolation control, if any of the axes exceed "[Pr.8] Speed control value", the axis exceeding the speed limit value is controlled using the speed limit value. The speeds of the other axes being interpolated are suppressed by the movement amount ratio.
- During 2-axis linear interpolation control or 2-axis fixed-feed control, "[Pr.20] Interpolation speed specification method" is set to "1: Reference axis speed", and if the reference axis is the minor axis and the interpolation axis is the major axis, the speed limit value of the interpolation axis may not function.
- In the 2-axis interpolation, the combination of the interpolation axes cannot be changed during the operation.
- For the interpolation axis, the reference axis "[Pr.7] Bias speed at start" is enabled.

Point

If reference axis speed is set for the interpolation control, set the major axis as the reference axis. If the minor axis is set as the reference axis, the speed of the major axis cannot be suppressed with [Pr.8] Speed limit value.

Interpolation speed specification method

For the interpolation control, set the composite speed or reference axis speed with "[Pr.20] Interpolation speed specification method" or "[Da.29] Interpolation speed specification method" of the reference axis.

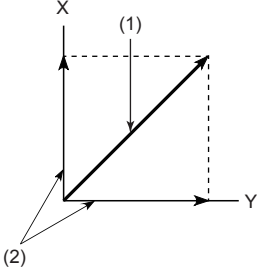
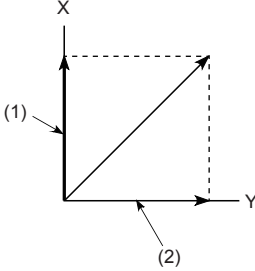
Composite speed	Reference axis speed
<p>The movement speed for the control target is specified, and the speed for each axis is calculated by the positioning module.</p>  <p>(1) Specify the composite speed (2) Positioning module calculations</p>	<p>The axis speed set in the reference axis is specified, and the speed for the other axis performing interpolation is calculated by the positioning module.</p>  <p>(1) Specify the reference axis speed (2) Positioning module calculations</p>

■ If specifying the interpolation speed for each positioning data

To specify the interpolation speed for each positioning data, use "[Da.29] Interpolation speed specification method".

■ If setting the same interpolation speed using all positioning data

- The interpolation speed specification method for all positioning data can be specified en block by setting "[Pr.20] Interpolation speed specification method".
- When "[Pr.20] Interpolation speed specification method" is used, set 0 in "[Da.29] Interpolation speed specification method". When a value other than 0 is set, "[Da.29] Interpolation speed specification method" is enabled.

Name	Function	Buffer memory address	
		Axis 1	Axis 2
[Pr.20] Interpolation speed specification method	When performing linear interpolation/circular interpolation, set whether to specify the composite speed or the speed for the reference axis. <ul style="list-style-type: none"> • 0: Composite speed • 1: Reference axis speed 	1550	1650
[Da.29] Interpolation speed specification method	Set "[Pr.20] Interpolation speed specification method" for each positioning data. 0: Use the set value of [Pr.20] Interpolation speed specification method 1: Composite speed 2: Reference axis speed	2003+N ^{*1} (b4 to b6)	8003+N ^{*1} (b4 to b6)

*1 N indicates the offset address of each positioning data.

$$N = ((\text{Positioning data No.}) - 1) \times 10$$

Limits of the interpolation control

Limits are provided on the interpolation control that can be implemented and speed ([Pr.20] Interpolation speed specification method) that can be set, depending on the settings in [Pr.1] Unit setting of the reference axis and interpolation axis. (For example, the circular interpolation control cannot be performed if the unit of the reference axis and that of the interpolation axis differ.)

The following table shows the limits of the interpolation control and speed specification.

○: Setting possible

×: Setting not possible

—: No interpolation axis

Interpolation control set in [Da.2] Control method	[Pr.20] Interpolation speed specification method	[Pr.1] Unit setting ^{*1}	
		The units of the reference axis and interpolation axis are the same, or the combination of mm and inch is used. ^{*4}	The units of the reference axis and interpolation axis differ ^{*4}
1-axis linear control 1-axis fixed-feed control Speed-position switching control Position-speed switching control	Composite speed	—	—
	Reference axis speed	—	—
2-axis linear interpolation control 2-axis fixed-feed control	Composite speed	○	×
	Reference axis speed	○	○
1-axis speed control	Composite speed	—	—
	Reference axis speed	—	—
2-axis speed control	Composite speed ^{*2}	×	×
	Reference axis speed	○	○
2-axis circular interpolation control	Composite speed	○ ^{*5}	×
	Reference axis speed ^{*3}	×	×

*1 The units of mm and inch can be mixed.

*2 If "composite speed" is set using 2-axis speed control to start positioning, an interpolation mode error (error code: 199AH) will occur, and positioning will not start.

*3 If "reference axis speed" is set using 2-axis circular interpolation control to start positioning, an interpolation mode error (error code: 199BH) will occur, and positioning will not start.

*4 If the units are different or if mm and inch are mixed, use the unit set to the reference axis for the unit of the speed being controlled.

*5 The unit of degree cannot be set. If circular interpolation control is set when the unit is "degree", circular interpolation (error code: 199FH) will occur, and positioning will not start. During the positioning control, the operation decelerates to stop at the detection of the error.

Axis operation status during the interpolation control

During the interpolation control, "2: Interpolation" is stored in [Md.26] Axis operation status. If "0: Standby" is saved when interpolation control finishes and an error occurs in the interpolation control, both the reference and interpolation axes will decelerate and stop, and "-1: Error in progress" will be saved.

9.2 Positioning Data Settings

Relation between each control and positioning data

The setting requirements and details on the setting items of the positioning data differ according to the setting in [Da.2] Control method.

The following table shows the setting items of positioning data prepared for various control systems. (This section presumes the positioning data will be set using GX Works3.)

◎: Always set

○: Set as required

×: Setting not possible (If these items are set, Continuous path control not possible (Error code: 1A1EH, 1A1FH) occurs at the start.)

—: Setting not required (The set value is ignored. Set the value within the setting range, such as the initial value.)

Setting items for positioning data			Position control		
			1-axis linear control 2-axis linear interpolation control	1-axis fixed-feed control 2-axis fixed-feed control	2-axis circular interpolation control
[Da.1]	Operation pattern	Independent positioning control (positioning complete)	◎	◎	◎
		Continuous positioning control	◎	◎	◎
		Continuous path control	◎	×	◎
[Da.2]	Control method	Line 1 Line 2 *1	Fixed-feed 1 Fixed-feed 2	Circular sub Circular right Circular left *1	
[Da.3]	Acceleration time No.	◎	◎	◎	
[Da.4]	Deceleration time No.	◎	◎	◎	
[Da.5]	Axis to be interpolated	◎: 2-axis interpolation control —: 1-axis control			
[Da.6]	Positioning address/movement amount	◎	◎	◎	
[Da.7]	Arc address	—	—	◎	
[Da.8]	Command speed	◎	◎	◎	
[Da.9]	Dwell time	○	○	○	
[Da.10]	M code	○	○	○	
[Da.27]	M code ON signal output timing	○	○	○	
[Da.28]	ABS direction in degrees	○	○	○	
[Da.29]	Interpolation speed specification method	—: 1-axis control ○: 2-axis interpolation control			

*1 Two control methods are available: Absolute (ABS) system and Incremental (INC) system.

Setting items for positioning data			Speed control		Speed-position switching control	Position-speed switching control
			1-axis speed control 2-axis speed control			
[Da.1]	Operation pattern	Independent positioning control (positioning complete)	◎	◎	◎	
		Continuous positioning control	×	◎	×	
		Continuous path control	×	×	×	
[Da.2]	Control method	Forward run speed 1 Reverse run speed 1 Forward run speed 2 Reverse run speed 2	Forward run speed-position Reverse run speed-position *2	Forward run position-speed Reverse run position-speed		
[Da.3]	Acceleration time No.	◎	◎	◎		
[Da.4]	Deceleration time No.	◎	◎	◎		
[Da.5]	Axis to be interpolated	◎: 2-axis interpolation control —: 1-axis control		—		

Setting items for positioning data		Speed control		Speed-position switching control	Position-speed switching control
		1-axis speed control	2-axis speed control		
[Da.6]	Positioning address/movement amount	—	—	◎	◎
[Da.7]	Arc address	—	—	—	—
[Da.8]	Command speed	◎	—	◎	◎
[Da.9]	Dwell time	—	—	○	○
[Da.10]	M code	○	—	○	○
[Da.27]	M code ON signal output timing	○	—	○	○
[Da.28]	ABS direction in degrees	○	—	○	○
[Da.29]	Interpolation speed specification method	—: 1-axis control ○: 2-axis interpolation control		—	—

*2 Two control methods are available: Absolute (ABS) system and Incremental (INC) system.

Setting items for positioning data			Other controls				
			NOP instruction	Current value change	JUMP instruction	LOOP instruction	LEND instruction
[Da.1]	Operation pattern	Independent positioning control (Positioning complete)	—	◎	—	—	—
		Continuous positioning control	—	◎	—	—	—
		Continuous path control	—	×	—	—	—
[Da.2]	Control method	NOP instruction	Current value change	JUMP instruction	LOOP instruction	LEND instruction	
[Da.3]	Acceleration time No.	—	—	—	—	—	
[Da.4]	Deceleration time No.	—	—	—	—	—	
[Da.5]	Axis to be interpolated	—	—	—	—	—	
[Da.6]	Positioning address/movement amount	—	◎ Address after change	—	—	—	
[Da.7]	Arc address	—	—	—	—	—	
[Da.8]	Command speed	—	—	—	—	—	
[Da.9]	Dwell time	—	—	◎ JUMP destination positioning data No.	—	—	
[Da.10]	M code	—	○	○ Condition data No. at JUMP	◎ Number of repetitions	—	
[Da.27]	M code ON signal output timing	—	○	—	—	—	
[Da.28]	ABS direction in degrees	—	—	—	—	—	
[Da.29]	Interpolation speed specification method	—	—	—	—	—	

Point

Setting "Positioning data" using GX Works3 as far as possible is recommended. To perform the setting using programs, many programs and devices are required. The execution becomes complicated, and the scan times will increase.

1-axis linear control

In the 1-axis linear control ([Da.2] Control method = ABS linear 1, INC linear 1), one motor is used to perform the position control in the set axis direction.

1-axis linear control (ABS linear 1)

■ Operation chart

In the 1-axis linear control of the absolute system, the positioning is performed from the current stop position (start point address) to the address set in [Da.6] Positioning address/movement amount (end point address).

[Example]

If the start point address (stop position) is 1000 and the end position address (positioning address) is 8000, positioning will be implemented using travel amount 7000 (8000-1000) in the forward direction.

Start point address (current stop position) End point address (positioning address)

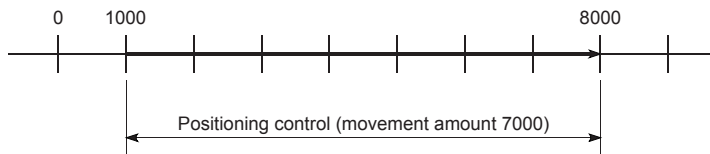

■ Positioning data to be set

To use the 1-axis linear control (ABS linear 1), set the following positioning data.

- ◎: Always set
- : Set as required
- : Setting not required

Setting item	Setting requirement
[Da.1] Operation pattern	◎
[Da.2] Control method	◎ (Set ABS linear 1.)
[Da.3] Acceleration time No.	◎
[Da.4] Deceleration time No.	◎
[Da.5] Axis to be interpolated	—
[Da.6] Positioning address/movement amount	◎
[Da.7] Arc address	—
[Da.8] Command speed	◎
[Da.9] Dwell time	○
[Da.10] M code	○
[Da.27] M code ON signal output timing	○
[Da.28] ABS direction in degrees	○
[Da.29] Interpolation speed specification method	—

For details on the settings, refer to the following.

☞ Page 423 Positioning Data

1-axis linear control (INC linear 1)

■ Operation chart

In the 1-axis linear control of the incremental system, the positioning for the movement amount set in [Da.6] Positioning address/movement amount is implemented from the current stop position (start point address). The movement direction is determined by the sign of the movement amount.

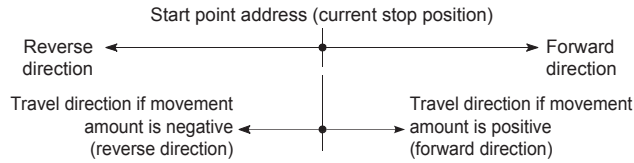

[Example]

If the travel amount is -7000 using a start point address of 5000, positioning will be implemented to the -2000 position.

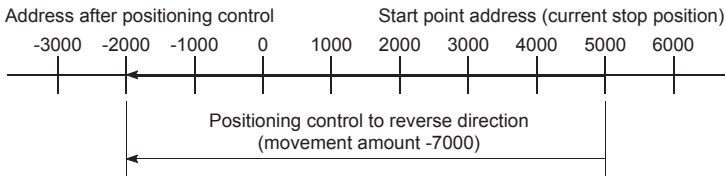

■ Positioning data to be set

To use the 1-axis linear control (INC linear 1), set the following positioning data.

- ◎: Always set
- : Set as required
- : Setting not required

Setting item	Setting requirement
[Da.1] Operation pattern	◎
[Da.2] Control method	◎ (Set INC linear 1.)
[Da.3] Acceleration time No.	◎
[Da.4] Deceleration time No.	◎
[Da.5] Axis to be interpolated	—
[Da.6] Positioning address/movement amount	◎
[Da.7] Arc address	—
[Da.8] Command speed	◎
[Da.9] Dwell time	○
[Da.10] M code	○
[Da.27] M code ON signal output timing	○
[Da.28] ABS direction in degrees	○
[Da.29] Interpolation speed specification method	—

For details on the settings, refer to the following.

☞ Page 423 Positioning Data

2-axis linear interpolation control

In the 2-axis linear interpolation control ([Da.2] Control method = ABS linear 2, INC linear 2), two motors are used to implement position control in a linear path while the interpolation is implemented for the axis directions set in each axis. For details on the interpolation control, refer to the following.

☞ Page 117 Interpolation control

2-axis linear interpolation control (ABS linear 2)

■ Operation chart

In the 2-axis linear interpolation control of the absolute system, specified two axes are used to implement linear interpolation positioning from the current stop position (start point address) to the address set in [Da.6] Positioning address/movement amount (end point address).

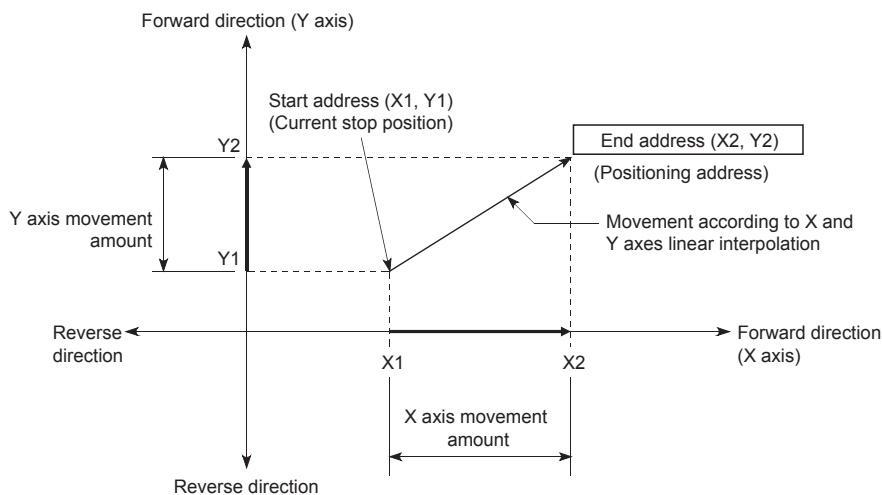

[Example]

If the start point address (current stop position) is (1000, 1000) and the end position address (positioning address) is (10000, 4000), positioning will be implemented as described below.

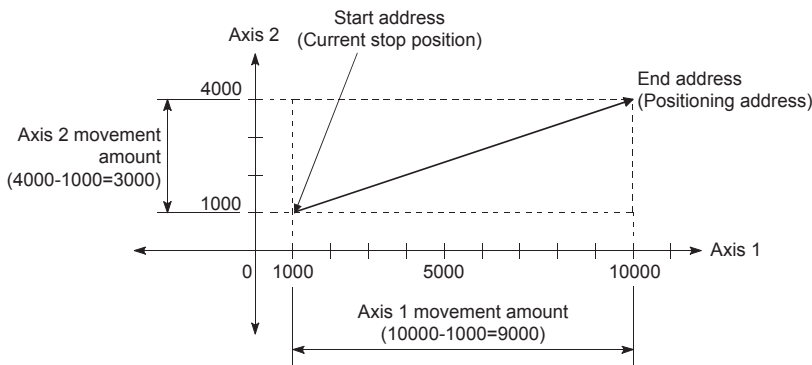

■ Restrictions

In the following case, an error occurs and the positioning will not start. During the positioning control, the operation stops immediately at the detection of the error.

- If the movement amount of each axis exceeds $1073741824 (= 2^{30})$ when 0: Composite speed is set in [Pr.20] Interpolation speed specification method, Outside linear movement amount range (Error code: 1A15H) occurs at the start of the positioning. (The maximum movement amount that can be set in [Da.6] Positioning address/movement amount is $1073741824 (= 2^{30})$.)

■ Positioning data to be set

To use the 2-axis linear interpolation control (ABS linear 2), set the following positioning data.

◎: Always set

○: Set as required

—: Setting not required

Setting item		Setting requirement of reference axis	Setting requirement of interpolation axis
[Da.1]	Operation pattern	◎	—
[Da.2]	Control method	◎ (Set ABS linear 2.)	—
[Da.3]	Acceleration time No.	◎	—
[Da.4]	Deceleration time No.	◎	—
[Da.5]	Axis to be interpolated	◎	—
[Da.6]	Positioning address/movement amount	◎	◎
[Da.7]	Arc address	—	—
[Da.8]	Command speed	◎	—
[Da.9]	Dwell time	○	—
[Da.10]	M code	○	—
[Da.27]	M code ON signal output timing	○	—
[Da.28]	ABS direction in degrees	○	—
[Da.29]	Interpolation speed specification method	○	—

For details on the settings, refer to the following.

 Page 423 Positioning Data

Restriction

If Reference axis speed is used for the 2-axis linear interpolation control, set the major axis as the reference axis. If the minor axis is set as the reference axis, the speed of the major axis cannot be suppressed with [Pr.8] Speed limit value.

2-axis linear interpolation control (INC linear 2)

■ Operation chart

In the 2-axis linear interpolation control of the incremental system, specified two axes are used to implement linear interpolation positioning for the movement amount set in [Da.6] Positioning address/movement amount from the current stop position (start point address). The movement direction is determined by the sign of the movement amount.

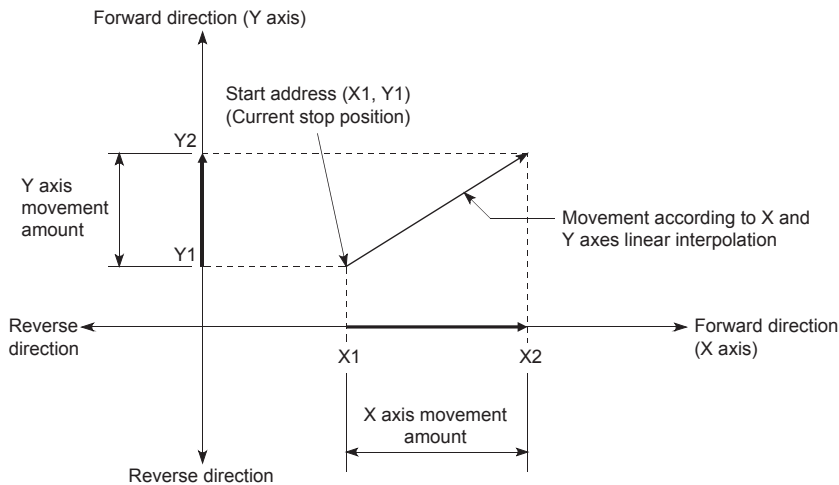

[Example]

If the axis 1 travel amount is 9000 and the axis 2 travel amount is -3000, the following will occur.

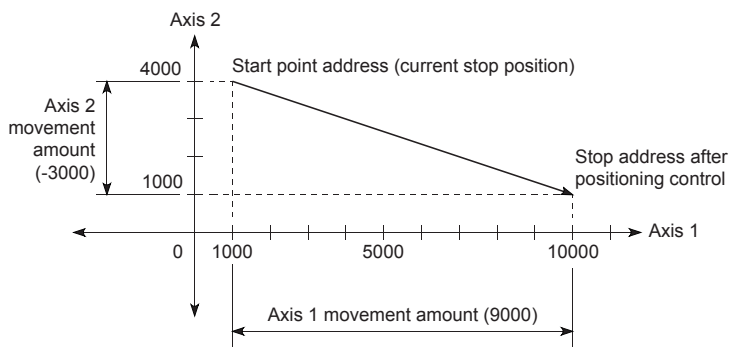

■ Restrictions

In the following case, an error occurs and the positioning will not start. During the positioning control, the operation stops immediately at the detection of the error.

- If the movement amount of each axis exceeds $1073741824 (= 2^{30})$ when 0: Composite speed is set in [Pr.20] Interpolation speed specification method, Outside linear movement amount range (Error code: 1A15H) occurs at the start of the positioning. (The maximum movement amount that can be set in [Da.6] Positioning address/movement amount is $1073741824 (= 2^{30})$.)

■ Positioning data to be set

To use the 2-axis linear interpolation control (INC linear 2), set the following positioning data.

◎: Always set

○: Set as required

—: Setting not required

Setting item		Setting requirement of reference axis	Setting requirement of interpolation axis
[Da.1]	Operation pattern	◎	—
[Da.2]	Control method	◎ (Set INC linear 2.)	—
[Da.3]	Acceleration time No.	◎	—
[Da.4]	Deceleration time No.	◎	—
[Da.5]	Axis to be interpolated	◎	—
[Da.6]	Positioning address/movement amount	◎	◎
[Da.7]	Arc address	—	—
[Da.8]	Command speed	◎	—
[Da.9]	Dwell time	○	—
[Da.10]	M code	○	—
[Da.27]	M code ON signal output timing	○	—
[Da.28]	ABS direction in degrees	○	—
[Da.29]	Interpolation speed specification method	○	—

For details on the settings, refer to the following.

 Page 423 Positioning Data

Restriction

If Reference axis speed is used for the 2-axis linear interpolation control, set the major axis as the reference axis. If the minor axis is set as the reference axis, the speed of the major axis cannot be suppressed with [Pr.8] Speed limit value.

Fixed-feed control

In Fixed-feed control ([Da.2] control method = Fixed-feed 1, fixed-feed 2), motors for the number of specified axes are used to perform the fixed-feed control in the set axis direction.

In the fixed-feed control, any remainder of the movement amount specified in the positioning data is rounded down to output the same amount of pulses if it is less than that required for control accuracy.

Operation chart

In the fixed-feed control, the address ([Md.20] Current feed value) of the current stop position (start point address) is set to 0, and the positioning for the movement amount set in [Da.6] Positioning address/movement amount is implemented. The movement direction is determined by the sign of the movement amount.

- Example of the 1-axis fixed-feed control

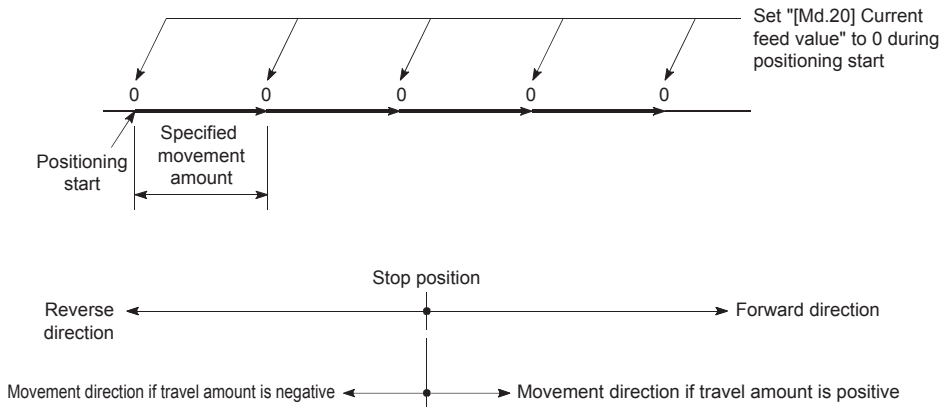

- Example of the 2-axis fixed-feed control

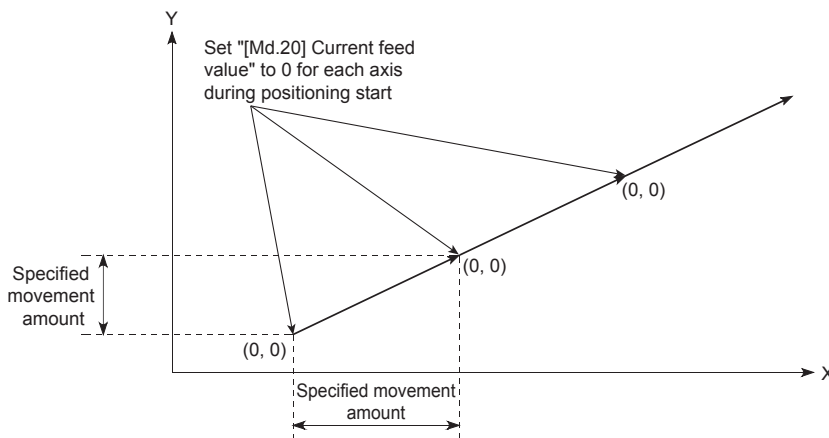

Restrictions

- If "11: Continuous path control" is set in [Da.1] Operation pattern, Continuous path control not possible (Error code: 1A1FH) occurs and the control will not start. (In the fixed-feed control, "11: Continuous path control" cannot be set.)
- Fixed-feed cannot be set in [Da.2] Control method in the positioning data when "11: Continuous path control" is set in [Da.1] Operation pattern of the immediately previous positioning data. For example, if the operation pattern of the positioning data No.1 is "11: Continuous path control", the fixed-feed control cannot be set to the positioning data No.2. If this setting is configured, Continuous path control not possible (Error code: 1A1FH) occurs and the deceleration stop is implemented.
- With 2-axis control, if the movement amount of each axis exceeds $1073741824 (= 2^{30})$ when 0: Composite speed is set in [Pr.20] Interpolation speed specification method, Outside linear movement amount range (Error code: 1A15H) occurs at the start of the positioning and the positioning will not start. (The maximum movement amount that can be set in [Da.6] Positioning address/movement amount is $1073741824 (= 2^{30})$.)

Positioning data to be set

To use the fixed-feed control, set the following positioning data.

◎: Always set

○: Set as required

—: Setting not required

Setting item	Setting requirement of reference axis	Setting requirement of interpolation axis
[Da.1] Operation pattern	◎	—
[Da.2] Control method	◎	—
[Da.3] Acceleration time No.	◎	—
[Da.4] Deceleration time No.	◎	—
[Da.5] Axis to be interpolated	—*1	—
[Da.6] Positioning address/movement amount	◎	◎
[Da.7] Arc address	—	—
[Da.8] Command speed	◎	—
[Da.9] Dwell time	○	—
[Da.10] M code	○	—
[Da.27] M code ON signal output timing	○	—
[Da.28] ABS direction in degrees	○	—
[Da.29] Interpolation speed specification method	○*2	—

*1 To use the 2-axis fixed-feed control (interpolation), the axis to be used as the interpolation axis needs to be set.

*2 To use the 1-axis fixed-feed control, the setting is not required.

For details on the settings, refer to the following.

☞ Page 423 Positioning Data

Point

- When the movement amount is converted to the actual number of output pulses, a fraction after the decimal point appears according to the movement amount per pulse. This fraction is usually retained in the positioning module and will be reflected at the next positioning. For the fixed-feed control, since the movement amount is maintained constant (= the number of output pulses is maintained constant), the control is implemented after the fractional pulses are cleared to 0 at the start.

[Accumulated fraction pulses/Truncation]

Movement amount per pulse = If 2.5 μm travel is implemented twice using 1.0 μm

⇒ Conversion to output pulses: $2.5 [\mu\text{m}]/1.0 = 2.5$ pulses

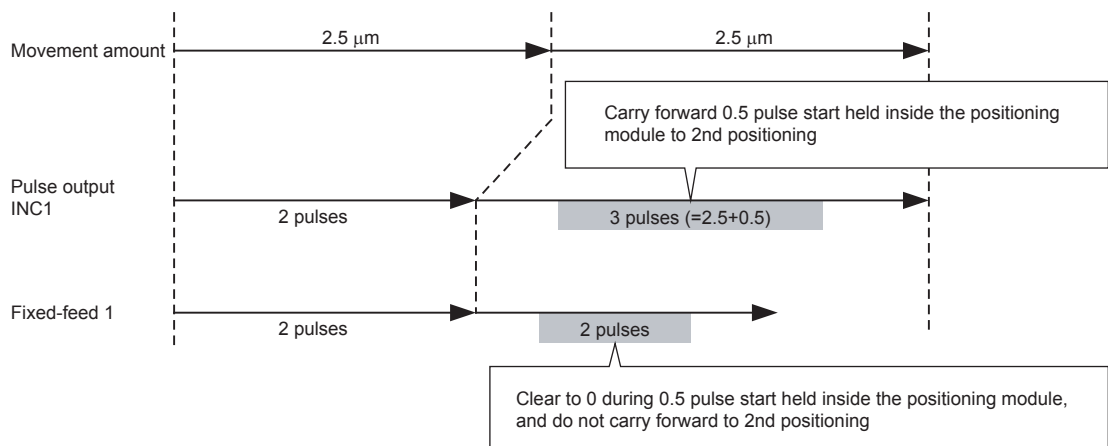

- If the reference axis speed is used for the 2-axis fixed-feed control, set the major axis as the reference axis. If the minor axis is set as the reference axis, the speed of the major axis cannot be suppressed with [Pr.8] Speed limit value.
- For the combinations of the reference axis and interpolation axes, refer to the following.

☞ Page 117 Interpolation control

2-axis circular interpolation control with the sub point specified

With 2-axis circular interpolation control ([Da.2] Control method = ABS circular interpolation, INC circular interpolation), 2 motors are used to implement positioning control using the circular path that passes through the specified sub points. For details on the interpolation control, refer to the following.

☞ Page 117 Interpolation control

2-axis circular interpolation control with sub point specified (ABS circular sub)

■Operation chart

In the absolute system and 2-axis circular interpolation control with sub point specified, the positioning is implemented from the current stop position (start point address) to the address (end point address) set in [Da.6] Positioning address/movement amount in a circular path passing through the sub point address (sub point address) set in [Da.7] Arc address.

The resulting control path is an arc whose center is the intersection point of the perpendicular bisectors of a straight line between the start point address (current stop position) and sub point address (arc address) and a straight line between the sub point address (arc address) and end point address (positioning address).

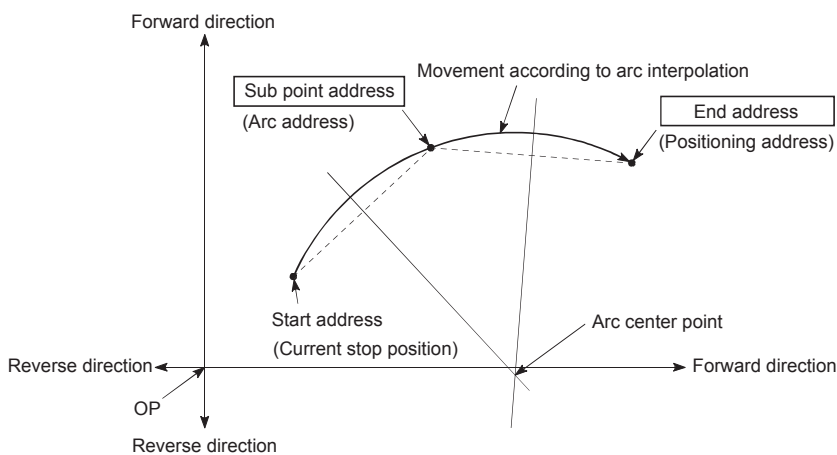

■Restrictions

In the following cases, the 2-axis circular interpolation control cannot be set.

- When "2: degree" is set in [Pr.1] Unit setting
- When the units set in [Pr.1] Unit setting are different between the reference axis and interpolation axis (The combination of "0: mm" and "1: inch" is possible.)
- When "1: Reference axis speed" is set in [Pr.20] Interpolation speed specification method

In the following case, an error occurs and the positioning will not start. During the positioning control, the operation stops immediately at the detection of the error.

Error code (HEX)	Error name	Error cause
1A32H	Outside radius range	When the radius exceeds $536870912 (= 2^{29})$ (The maximum radius for which the circular interpolation control is possible is $536870912 (= 2^{29})$.)
1A37H	Sub point setting error	When the center point address is out of the range of $-2147483648 (-2^{31})$ to $2147483647 (2^{31}-1)$.
1A2BH	End point setting error	Start point address = End point address
1A27H	Sub point setting error	Start point address = Sub point address
1A28H	Sub point setting error	End point address = Sub point address
1A29H	Sub point setting error	When the start point address, sub point address, and end point address are on a straight line

■ Positioning data to be set

To use the 2-axis circular interpolation control with sub point specified (ABS circular sub), set the following positioning data.

◎: Always set

○: Set as required

—: Setting not required

Setting item		Setting requirement of reference axis	Setting requirement of interpolation axis
[Da.1]	Operation pattern	◎	—
[Da.2]	Control method	◎ (Set ABS circular sub.)	—
[Da.3]	Acceleration time No.	◎	—
[Da.4]	Deceleration time No.	◎	—
[Da.5]	Axis to be interpolated	◎	—
[Da.6]	Positioning address/movement amount	◎	◎
[Da.7]	Arc address	◎	◎
[Da.8]	Command speed	◎	—
[Da.9]	Dwell time	○	—
[Da.10]	M code	○	—
[Da.27]	M code ON signal output timing	○	—
[Da.28]	ABS direction in degrees	○	—
[Da.29]	Interpolation speed specification method	○	—

For details on the settings, refer to the following.

 Page 423 Positioning Data

Restriction

Set a value in [Da.8] Command speed so that the speed of each axis does not exceed the value in [Pr.8] Speed limit value. (The speed limit does not function for the speed calculated using the positioning module.)

2-axis circular interpolation control with sub point specified (INC circular sub)

■Operation chart

In the incremental system and 2-axis circular interpolation control with sub point specified, the positioning is implemented from the current stop position (start point address) to the position of the movement amount set in [Da.6] Positioning address/movement amount in an arc path passing through the sub point address (sub point address) set in [Da.7] Arc address. The movement direction is determined by the sign of the movement amount.

The resulting control path is an arc whose center is the intersection point of the perpendicular bisectors of a straight line between the start point address (current stop position) and the sub point address (arc address) calculated from the movement amount to the sub point, and a straight line between the sub point address (arc address) and the end point address (positioning address) calculated from the movement amount to the end point.

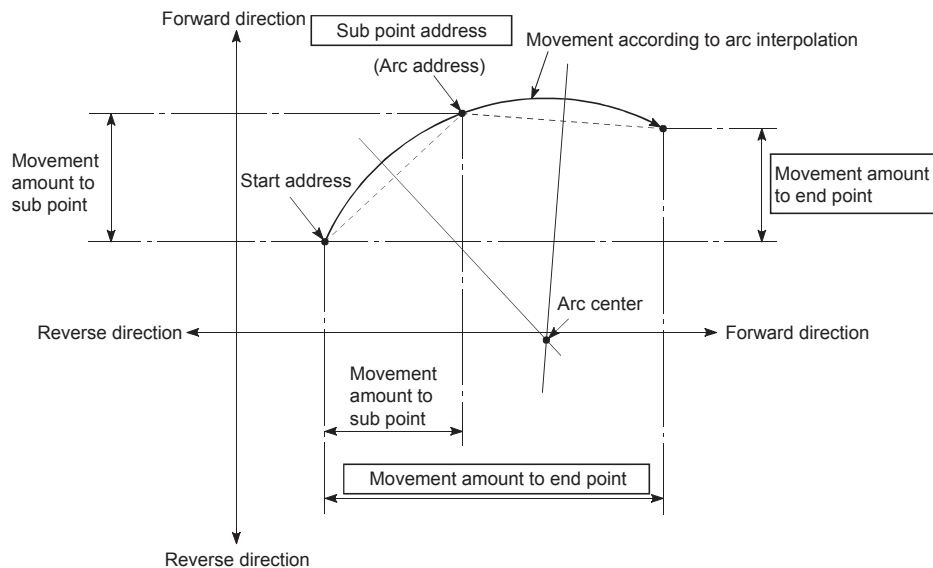

■Restrictions

In the following cases, the 2-axis circular interpolation control cannot be set.

- When "2: degree" is set in [Pr.1] Unit setting
- When the units set in [Pr.1] Unit setting are different between the reference axis and interpolation axis (The combination of "0: mm" and "1: inch" is possible.)
- When "1: Reference axis speed" is set in [Pr.20] Interpolation speed specification method

In the following case, an error occurs and the positioning will not start. During the positioning control, the operation stops immediately at the detection of the error.

Error code (HEX)	Error name	Error cause
1A32H	Outside radius range	When the radius exceeds 536870912 (= 2^{29}) (The maximum radius for which the circular interpolation control is possible is 536870912 (= 2^{29}).
1A2AH	Sub point setting error	When the sub point address is out of the range of -2147483648 (-2^{31}) to 2147483647 ($2^{31}-1$).
1A2CH	End point setting error	When the end point address is out of the range of -2147483648 (-2^{31}) to 2147483647 ($2^{31}-1$).
1A37H	Sub point setting error	When the center point address is out of the range of -2147483648 (-2^{31}) to 2147483647 ($2^{31}-1$).
1A2BH	End point setting error	Start point address = End point address
1A27H	Sub point setting error	Start point address = Sub point address
1A28H	Sub point setting error	End point address = Sub point address
1A29H	Sub point setting error	When the start point address, sub point address, and end point address are on a straight line

■ Positioning data to be set

To use the 2-axis circular interpolation control with sub point specified (INC circular sub), set the following positioning data.

◎: Always set

○: Set as required

—: Setting not required

Setting item		Setting requirement of reference axis	Setting requirement of interpolation axis
[Da.1]	Operation pattern	◎	—
[Da.2]	Control method	◎ (Set INC circular sub.)	—
[Da.3]	Acceleration time No.	◎	—
[Da.4]	Deceleration time No.	◎	—
[Da.5]	Axis to be interpolated	◎	—
[Da.6]	Positioning address/movement amount	◎	◎
[Da.7]	Arc address	◎	◎
[Da.8]	Command speed	◎	—
[Da.9]	Dwell time	○	—
[Da.10]	M code	○	—
[Da.27]	M code ON signal output timing	○	—
[Da.28]	ABS direction in degrees	○	—
[Da.29]	Interpolation speed specification method	○	—

For details on the settings, refer to the following.

 Page 423 Positioning Data

Restriction

Set a value in [Da.8] Command speed so that the speed of each axis does not exceed the value in [Pr.8] Speed limit value. (The speed limit does not function for the speed calculated using the positioning module.)

2-axis circular interpolation control with the center point specified

In 2-axis circular interpolation control ([Da.2] Control method = ABS circular right, INC circular right, ABS circular left, and INC circular left), two motors are used to perform the position control in an arc path centered at the arc address while the interpolation is implemented for the axis directions set in each axis.

For details on the interpolation control, refer to the following.

☞ Page 117 Interpolation control

The following table shows the rotation directions, central angle of the arc that can be controlled, and positioning path.

Control method	Rotation direction	Central angle of the arc that can be controlled	Positioning path
ABS circular right INC circular right	Clockwise	$0^\circ < \theta \leq 360^\circ$	
ABS circular left INC circular left			

Circular interpolation error compensation

In the circular interpolation control with the center point specification, the arc path calculated with the start point address and center point address and the end point address set in [Da.6] Positioning address/movement amount may deviate. (Page 411 [Pr.41] Allowable circular interpolation error width)

■ Calculated error \leq [Pr.41] Allowable circular interpolation error width

The circular interpolation control to the set end point address is performed, while the error compensation is performed. (This operation is called spiral interpolation.)

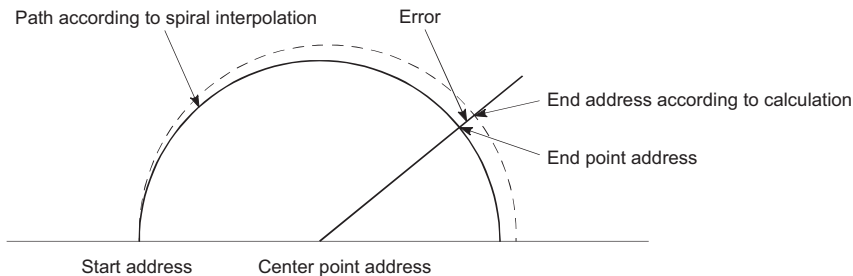

In the circular interpolation control with the center point specified, an angular velocity is calculated with an assumption that the positioning target moves at the command speed on the arc using the radius calculated from the start point address and center point address. The radius is compensated in proportion to the angular velocity moved from the start point.

Thus, if a difference (error) is found between a radius (start point radius) calculated from the start point address and center point address and a radius (end point radius) calculated from the end point address and center point address, the composite speed differs from the command speed and as described below.

Error between start point radius and end point radius	Composite speed
Start point radius > End point radius	Compared with the speed without an error, the speed becomes slower as the end point address is reached.
Start point radius < End point radius	Compared with the speed without an error, the speed becomes faster as the end point address is reached.

■ Calculated error \geq [Pr.41] Allowable circular interpolation error width

Large arc error deviation (Error code: 1A17H) occurs at the start of the positioning and the control will not start.

During the positioning control, the operation stops immediately at the detection of the error.

The 2-axis circular interpolation control with the center point specified (ABS circular right, ABS circular left)

■ Operation chart

In the absolute system and 2-axis circular interpolation control with center point specified, positioning is implemented from the current stop position (start point address) to the address (end point address) set in [Da.6] Positioning address/movement amount in an arc path whose center is the center point address (arc address) set in [Da.7] Arc address.

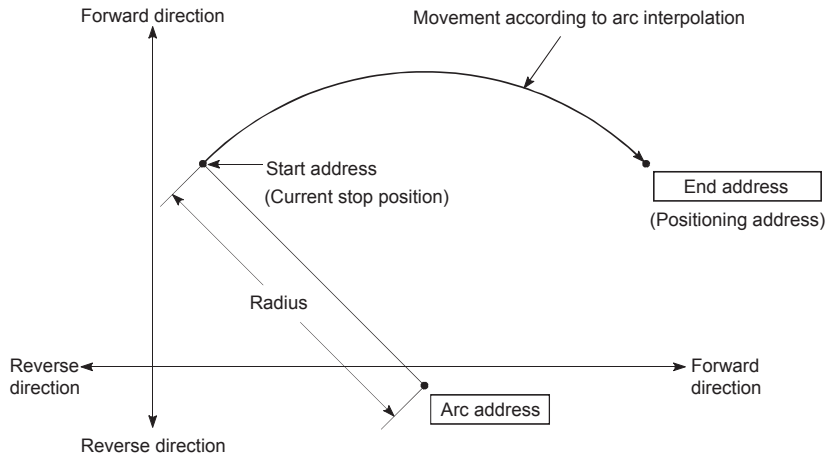

If the end point address (positioning address) is set to be the same as the start point address, the positioning of a true circle whose radius is from the start point address to the center point of the arc can be implemented.

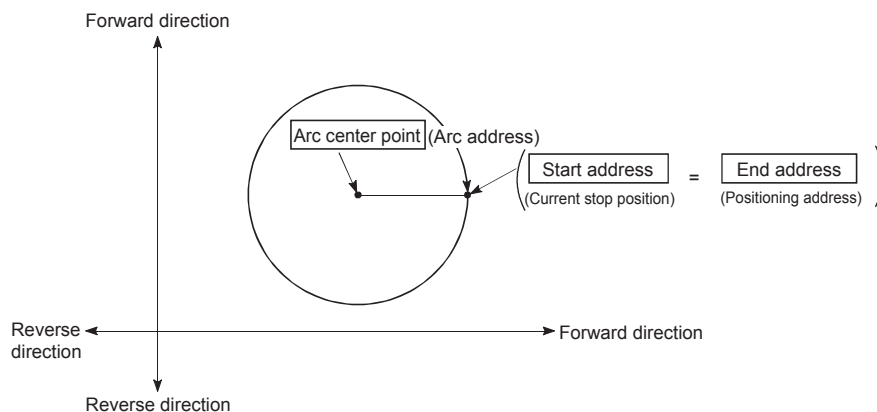

In the circular interpolation control with the center point specified, an angular velocity is calculated with an assumption that the positioning target moves at the command speed on the arc using the radius calculated from the start point address and center point address. The radius is compensated in proportion to the angular velocity moved from the start point.

Thus, if a difference (error) is found between a radius (start point radius) calculated from the start point address and center point address and a radius (end point radius) calculated from the end point address and center point address, the composite speed differs from the command speed and as described below.

Error between start point radius and end point radius	Composite speed
Start point radius > End point radius	Compared with the speed without an error, the speed becomes slower as the end point address is reached.
Start point radius < End point radius	Compared with the speed without an error, the speed becomes faster as the end point address is reached.

■Restrictions

In the following cases, the 2-axis circular interpolation control cannot be set.

- When "2: degree" is set in [Pr.1] Unit setting
- When the units set in [Pr.1] Unit setting are different between the reference axis and interpolation axis (The combination of "0: mm" and "1: inch" is possible.)
- When "1: Reference axis speed" is set in [Pr.20] Interpolation speed specification method

In the following case, an error occurs and the positioning will not start. During positioning control, the operation stops immediately at the detection of the error.

Error code (HEX)	Error name	Error cause
1A32H	Outside radius range	When the radius exceeds 536870912 (= 2^{29}) (The maximum radius for which the circular interpolation control is possible is 536870912 (= 2^{29})).
1A2DH	Center point setting error	Start point address = Center point address
1A2EH	Center point setting error	End point address = Center point address
1A2FH	Center point setting error	When the center point address is out of the range of -2147483648 (-2^{31}) to 2147483647 ($2^{31}-1$)

■Positioning data to be set

To use the 2-axis circular interpolation control with center point specified (ABS circular right, ABS circular left), set the following positioning data.

◎: Always set

○: Set as required

—: Setting not required

Setting item	Setting requirement of reference axis	Setting requirement of interpolation axis
[Da.1] Operation pattern	◎	—
[Da.2] Control method	◎ (Set ABS circular right or ABS circular left.)	—
[Da.3] Acceleration time No.	◎	—
[Da.4] Deceleration time No.	◎	—
[Da.5] Axis to be interpolated	◎	—
[Da.6] Positioning address/movement amount	◎	◎
[Da.7] Arc address	◎	◎
[Da.8] Command speed	◎	—
[Da.9] Dwell time	○	—
[Da.10] M code	○	—
[Da.27] M code ON signal output timing	○	—
[Da.28] ABS direction in degrees	○	—
[Da.29] Interpolation speed specification method	○	—

For details on the settings, refer to the following.

📖 Page 423 Positioning Data

Restriction

Set a value in [Da.8] Command speed so that the speed of each axis does not exceed the value in [Pr.8] Speed limit value. (The speed limit does not function for the speed calculated using the positioning module.)

The 2-axis circular interpolation control with the center point specified (INC circular right, INC circular left)

■Operation chart

In the incremental system and 2-axis circular interpolation control with center point specified, positioning is implemented from the current stop position (start point address) to the position of the movement amount set in [Da.6] Positioning address/ movement amount in an arc path whose center is the center point address (arc address) set in [Da.7] Arc address.

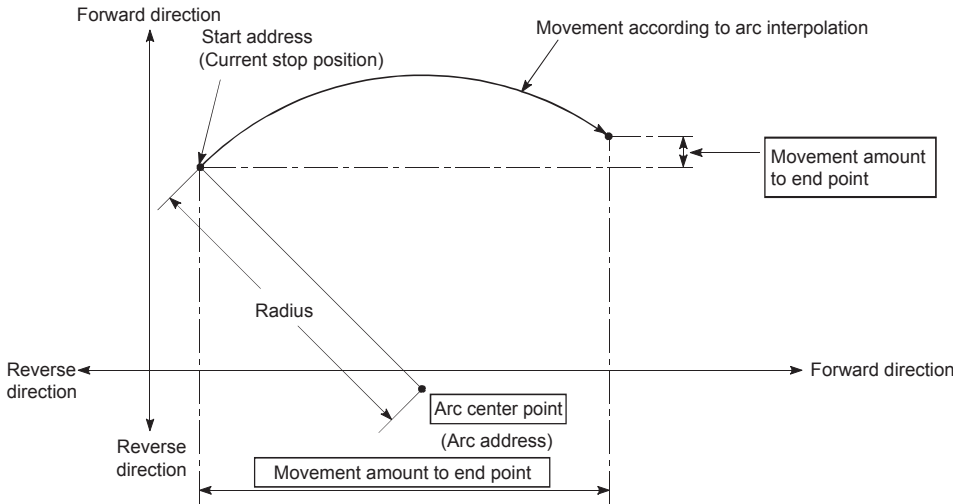

If 0 is set for the movement amount, the positioning of a true circle whose radius is from the start point address to the center point address of the arc can be performed.

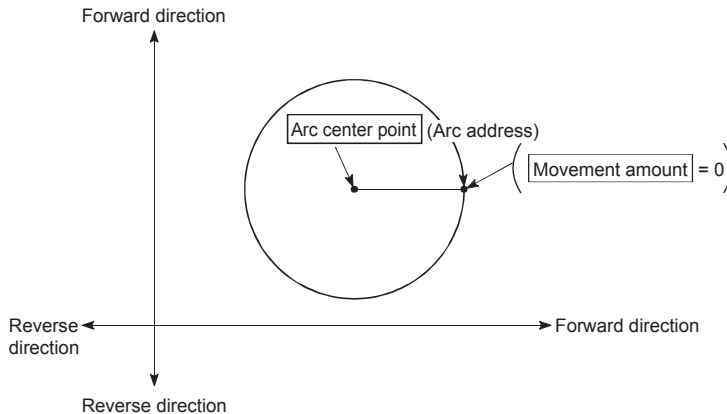

In the circular interpolation control with the center point specified, an angular velocity is calculated with an assumption that the positioning target moves at the command speed on the arc using the radius calculated from the start point address and center point address. The radius is compensated in proportion to the angular velocity moved from the start point.

Thus, if a difference (error) is found between a radius (start point radius) calculated from the start point address and center point address and a radius (end point radius) calculated from the end point address and center point address, the composite speed differs from the command speed and as described below.

Error between start point radius and end point radius	Composite speed
Start point radius > End point radius	Compared with the speed without an error, the speed becomes slower as the end point address is reached.
Start point radius < End point radius	Compared with the speed without an error, the speed becomes faster as the end point address is reached.

■Restrictions

In the following cases, the 2-axis circular interpolation control cannot be set.

- When "2: degree" is set in [Pr.1] Unit setting
- When the units set in [Pr.1] Unit setting are different between the reference axis and interpolation axis (The combination of "0: mm" and "1: inch" is possible.)
- When "1: Reference axis speed" is set in [Pr.20] Interpolation speed specification method

In the following case, an error occurs and the positioning will not start. During positioning control, the operation stops immediately at the detection of the error.

Error code (HEX)	Error name	Error cause
1A32H	Outside radius range	When the radius exceeds 536870912 (= 2^{29}) (The maximum radius for which the circular interpolation control is possible is 536870912 (= 2^{29})).
1A2CH	End point setting error	When the end point address is out of the range of -2147483648 (-2^{31}) to 2147483647 ($2^{31}-1$)
1A2DH	Center point setting error	Start point address = Center point address
1A2EH	Center point setting error	End point address = Center point address
1A2FH	Center point setting error	When the center point address is out of the range of -2147483648 (-2^{31}) to 2147483647 ($2^{31}-1$)

■Positioning data to be set

To use the 2-axis circular interpolation control with center point specified (INC circular right, INC circular left), set the following positioning data.

◎: Always set

○: Set as required

—: Setting not required

Setting item	Setting requirement of reference axis	Setting requirement of interpolation axis
[Da.1] Operation pattern	◎	—
[Da.2] Control method	◎ (Set INC circular right or INC circular left.)	—
[Da.3] Acceleration time No.	◎	—
[Da.4] Deceleration time No.	◎	—
[Da.5] Axis to be interpolated	◎	—
[Da.6] Positioning address/movement amount	◎	◎
[Da.7] Arc address	◎	◎
[Da.8] Command speed	◎	—
[Da.9] Dwell time	○	—
[Da.10] M code	○	—
[Da.27] M code ON signal output timing	○	—
[Da.28] ABS direction in degrees	○	—
[Da.29] Interpolation speed specification method	○	—

For details on the settings, refer to the following.

📖 Page 423 Positioning Data

Restriction

Set a value in [Da.8] Command speed so that the speed of each axis does not exceed the value in [Pr.8] Speed limit value. (The speed limit does not function for the speed calculated using the positioning module.)

Speed control

In the speed control ([Da.2] Control method = Forward run speed 1 to 2, Reverse run speed 1 to 2), pulses are output continuously at the speed set in [Da.8] Command speed until a stop command is input in the axis 1 to 2 directions set to the positioning data.

The speed control has four control types including Forward run speed 1 to 2 performed in the forward run direction and Reverse run speed 1 to 2 performed in the reverse run direction.

For the combinations of the reference axis and interpolation axes, refer to the following.

☞ Page 117 Interpolation control

Operation chart

The following shows the operation timing for the 1-axis speed control with the axis 1 and the 2-axis speed control in which the axis 1 is used as the reference axis.

During the speed control, In speed control flag ([Md.31] Status: b0) is ON. (Reference axis only)

Positioning complete signal ([Md.31] Status: b15) does not turn ON.

- 1-axis speed control

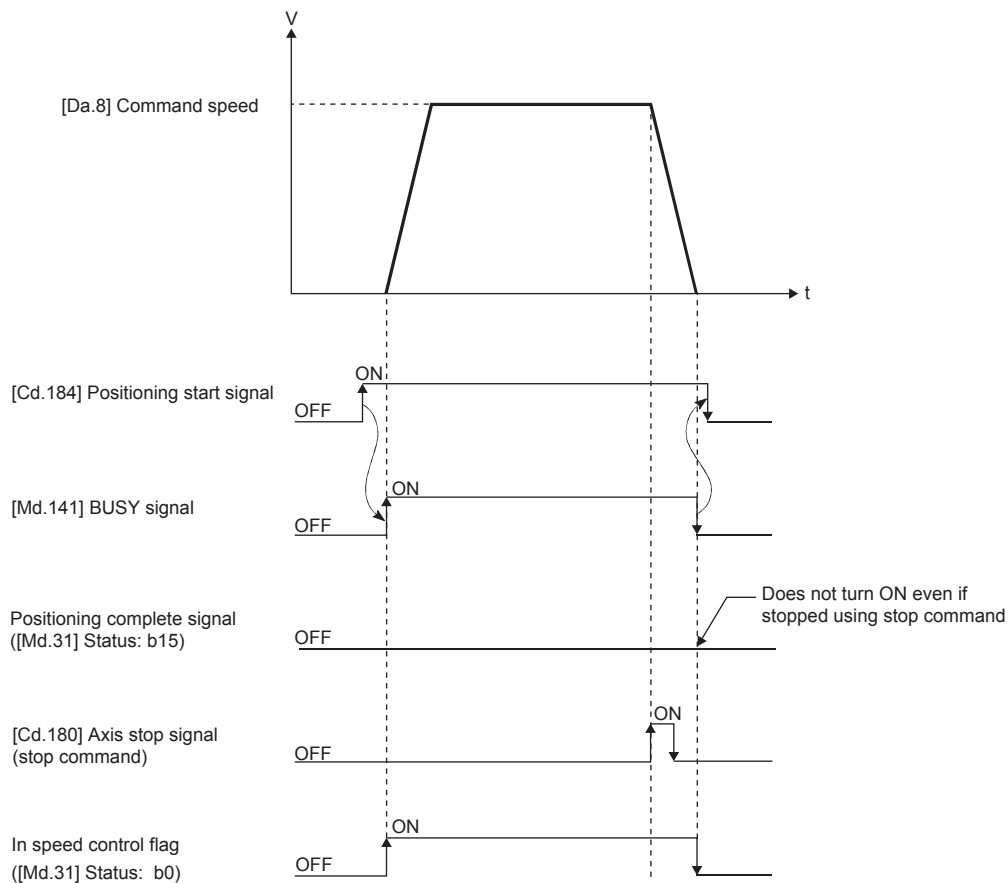

• 2-axis speed control

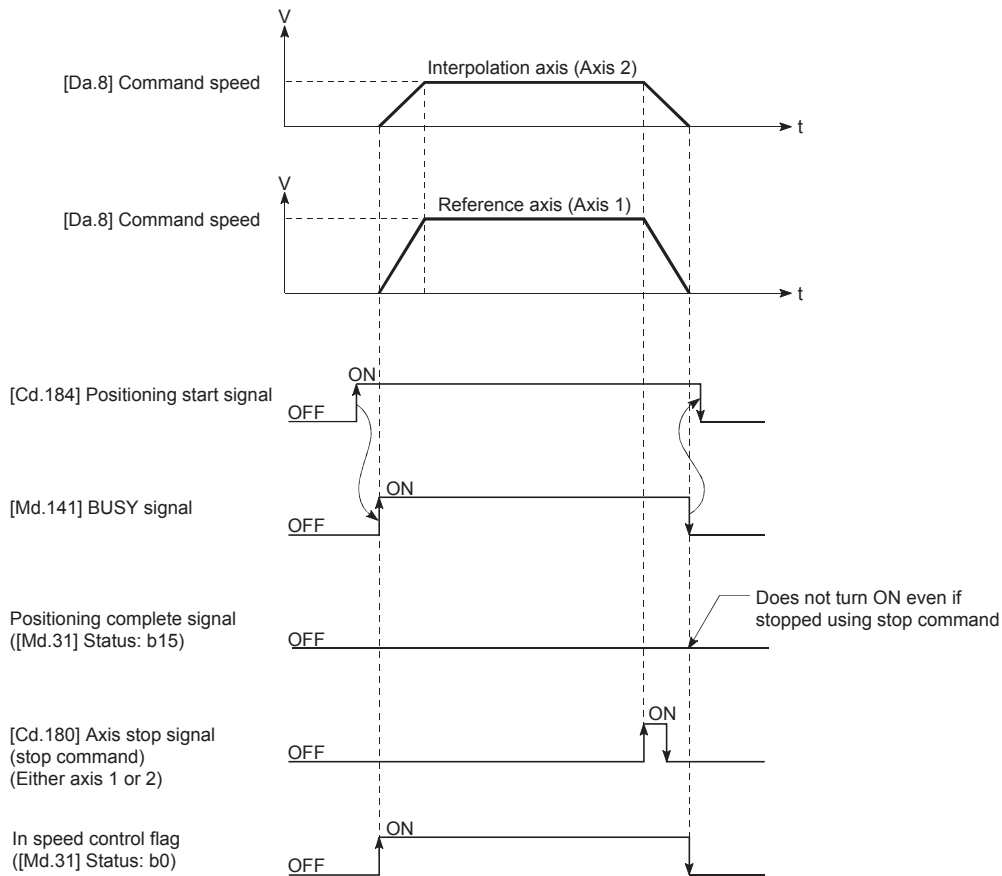

Current feed value

[Md.20] Current feed value during the speed control depends on the setting of [Pr.21] Current feed value during speed control as follows. (However, the parameters use the set value of the reference axis)

Setting of [Pr.21] Current feed value during speed control	[Md.20] Current feed value
0: Current feed value is not updated	The current feed value during speed control start is maintained.
1: Update current feed value	The current feed value is updated.
2: Current feed value is cleared to zero	The current feed value is fixed to 0.

■ If the current feed value is not updated

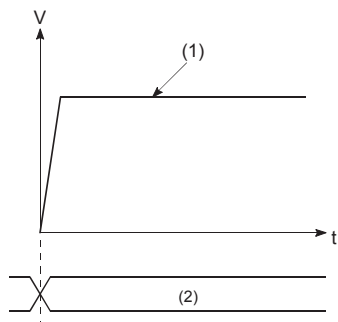

(1) Speed control in operation
 (2) The current feed value during speed control start is maintained

■ If updating the current feed value

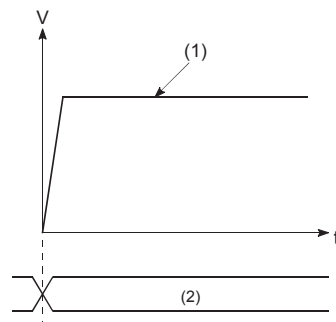

(1) Speed control in operation
 (2) The current feed value is updated

■ If the current feed value is cleared to zero

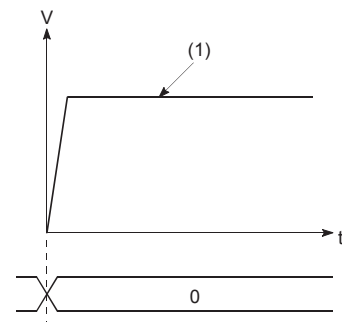

(1) Speed control in operation

Restrictions

- Set "00: Positioning complete" to [Da.1] Operation pattern. If "01: Continuous positioning control" or "11: Continuous path control" is set, Continuous path control not possible (Error code: 1A1EH, 1A1FH) occurs and the control will not start. ("01: Continuous positioning control" or "11: Continuous path control" cannot be set for the speed control.)
- If using M codes, set "0: WITH mode" in "[Pr.18] M code ON signal output timing". If "1: AFTER mode" has been set, M code is not output, and M code ON signal ([Md.31] Status: b12) does not turn ON either.
- If Current speed (-1) is set to [Da.8] Command speed, No command speed (Error code: 1A13H) occurs.
- When the unit is degree, the software stroke limit is not checked.
- Set "1: Reference axis speed" to "[Pr.20] Interpolation speed specification method". If "0: Composite speed" is set, Interpolation mode error (Error code: 199AH) occurs and the positioning will not start.

■Restriction on speed limit value

If any axis of the control axes (1 to 2 axes) exceeds the speed limit value, the axis exceeding the speed limit value is controlled with the speed limit value. In this case, the speeds of the other axes are limited by the ratio of [Da.8] Command speed.

Ex.

When the axis 1 and 2 are used

Setting item		Axis 1	Axis 2
[Pr.8]	Speed limit value	4000.00 mm/min	5000.00 mm/min
[Da.8]	Command speed	8000.00 mm/min	6000.00 mm/min

When the values above are set, the operating speed during the speed control is as follows.

- Axis 1: 4000.00 mm/min (the speed is limited by "[Pr.8] Speed limit value".)
- Axis 2: 3000.00 mm/min (the speed is limited by the ratio of the command speeds of the axes 1 and 2.)

When the reference axis speed is less than 1 as the result of the speed limit, the operation is performed at the speed 1. When the bias speed is set, the lowest speed is the bias speed.

Positioning data to be set

To use the speed control (Forward run speed 1 to 2, Reverse run speed 1 to 2), set the following positioning data.

◎: Always set

○: Set as required

—: Setting not required

Setting item	Setting requirement of reference axis	Setting requirement of interpolation axis
[Da.1]	Operation pattern	◎
[Da.2]	Control method	◎
[Da.3]	Acceleration time No.	◎
[Da.4]	Deceleration time No.	◎
[Da.5]	Axis to be interpolated	—*1
[Da.6]	Positioning address/movement amount	—
[Da.7]	Arc address	—
[Da.8]	Command speed	◎
[Da.9]	Dwell time	—
[Da.10]	M code	○
[Da.27]	M code ON signal output timing	○
[Da.28]	ABS direction in degrees	○
[Da.29]	Interpolation speed specification method	—*2

*1 To use the 2-axis speed control (interpolation), the axis to be used as the interpolation axis needs to be set.

*2 To use the 1-axis speed control, the setting is not required.

For details on the settings, refer to the following.

☞ Page 423 Positioning Data

Speed-position switching control (INC mode)

In the speed-position switching control (INC mode) ([Da.2] Control method = Forward run speed-position, Reverse run speed-position), pulses are output continuously at the speed set in [Da.8] Command speed in the axis direction set to the positioning data. When Speed-position switching signal is input, the position control for the movement amount set in [Da.6] Positioning address/movement amount is implemented.

The speed-position switching control (INC mode) has two control types including Forward run speed-position implemented in the forward run direction and Reverse run speed-position implemented in the reverse run direction.

Set the speed-position switching control (INC mode) selection using "[Pr.150] Speed-position function selection".

Setting item		Setting value	Setting details	Buffer memory address	
				Axis 1	Axis 2
[Pr.150]	Speed-position function selection	0	Speed-position switching control (INC mode)	34	184

If a value other than 0 and 2 is set, the control is performed in the INC mode with the setting value regarded as 0.

For details on the settings, refer to the following.

☞ Page 403 [Pr.150] Speed-position function selection

Switching from the speed control→position control

- Select a method to switch from the speed control to position control setting the value of [Cd.45] Speed-position switching device selection.

Setting item		Setting value	Setting details	Buffer memory address	
				Axis 1	Axis 2
[Cd.45]	Speed-position switching device selection	0, 1, 2	Select the device used for the speed to position switching. <ul style="list-style-type: none"> • 0: Use External command signal • 1: Use Near-point dog signal • 2: Use "[Cd.46] Speed-position switching command" 	1566	1666

- To switch the speed control to the position control, [Cd.24] Speed-position switching enable flag must be turned on and positioning data must be set. (When "[Cd.24] Speed-position switching enable flag" is turned ON after Speed-position switching signal is turned ON, speed control→position control switching is not implemented. The speed control is switched to the position control when the speed-position switching signal is turned from OFF→ON again. If [Cd.24] Speed-position switching enable flag and External command signal are turned ON at the start of the control, only the position control is implemented.)

Setting item		Setting value	Setting details	Buffer memory address	
				Axis 1	Axis 2
[Cd.24]	Speed-position switching enable flag	1	Set whether to enable or disable speed-position switching signals <ul style="list-style-type: none"> • 0: Speed control is not switched to position control even when the speed-position switching signal is turned ON. • 1: Speed control is switched to position control when the speed-position switching signal is turned ON. 	1528	1628

Speed-position switching signal setting

■When External command signal (CHG) is used

To use External command signal (CHG) as a speed-position switching signal, set the following items.

Setting item		Setting value	Setting details	Buffer memory address	
				Axis 1	Axis 2
[Pr.42]	External command function selection	2	Set "2: Speed-position/position-speed switching request".	62	212
[Cd.8]	External command valid	1	Set "1: Validate external command".	1505	1605
[Cd.45]	Speed-position switching device selection	0	Set "0: Use external command signals".	1566	1666

■When Near-point dog signal (DOG) is used

To use Near-point dog signal (DOG) as a speed-position switching signal, set the following items.

Setting item		Setting value	Setting details	Buffer memory address	
				Axis 1	Axis 2
[Cd.45]	Speed-position switching device selection	1	Set "1: Use near-point dog signals".	1566	1666

[Pr.42] External command function selection and [Cd.8] External command valid are not required to be set.

■When [Cd.46] Speed-position switching command is used

To use [Cd.46] Speed-position switching command as Speed-position switching signal, set the following items.

Setting item		Setting value	Setting details	Buffer memory address	
				Axis 1	Axis 2
[Cd.45]	Speed-position switching device selection	2	Set "2: Use [Cd.46] Speed↔position switching commands".	1566	1666

- [Pr.42] External command function selection and [Cd.8] External command valid are not required to be set.
- Compared with the switching control using Speed-position switching signal, the operation delays for 0.88 ms at maximum in the switching control using [Cd.46] Speed-position switching command. If the responsiveness for the switching signal is required, use Speed-position switching signal.

Operation chart

The following shows the operation timing of the speed-position switching control (INC mode).

During the speed control with the speed-position switching control (INC mode), In speed control flag ([Md.31] Status: b0) is ON.

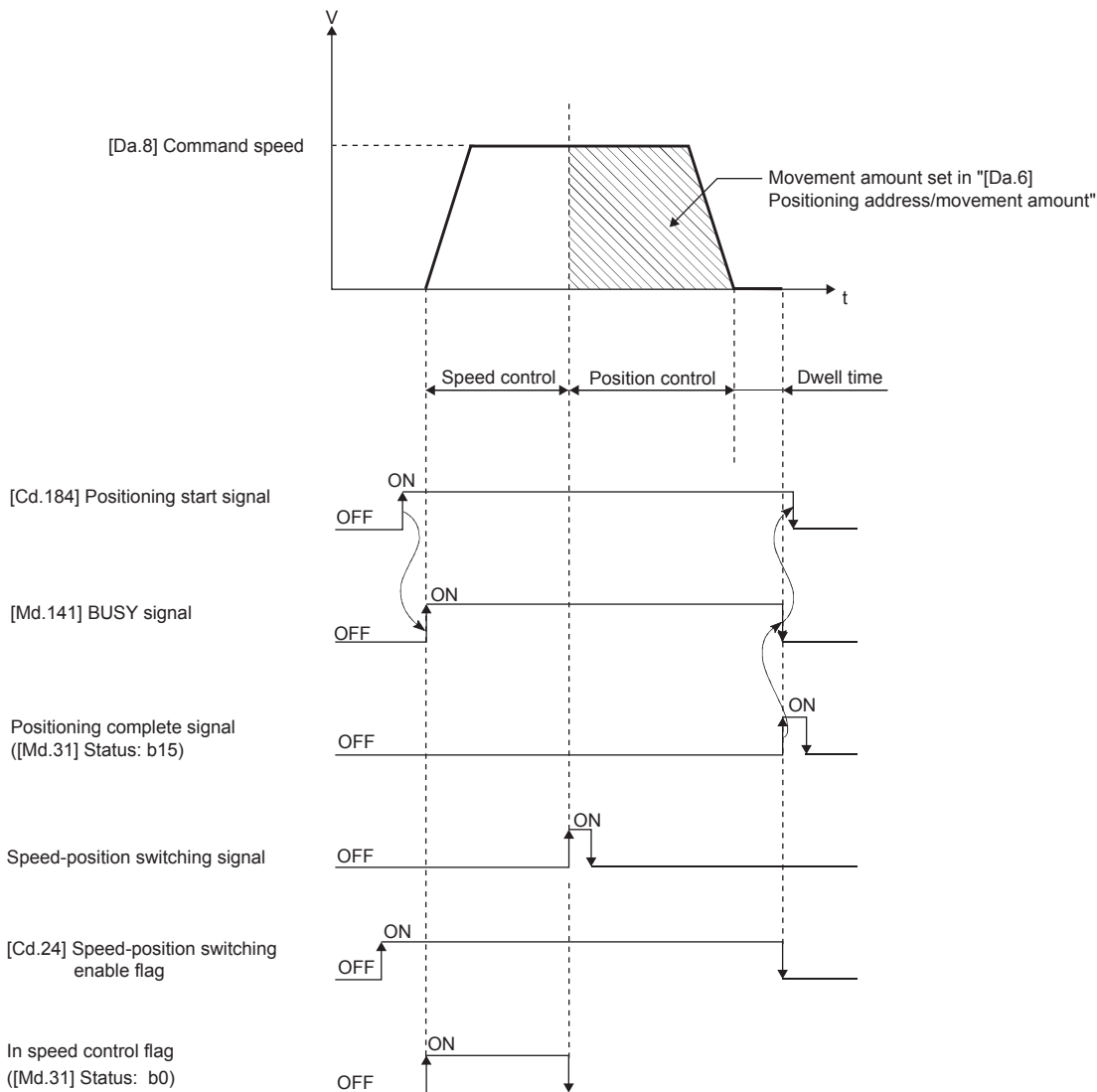

■ Operation example

The following figure shows the operation when a speed-position switching signal is input at the position where the current feed value is 90.00000 (degree) during the implementation of forward run speed-position in [Da.2] Control method with the settings as follows: [Pr.1] Unit setting is "2: degree" and [Pr.21] Current feed value during speed control is "1: Update current feed value". (The set value of [Da.6] Positioning address/movement amount is 270.00000 (degree).)

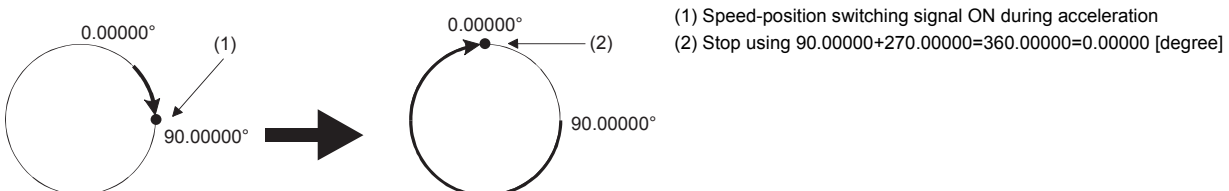

Operation timing and the processing time

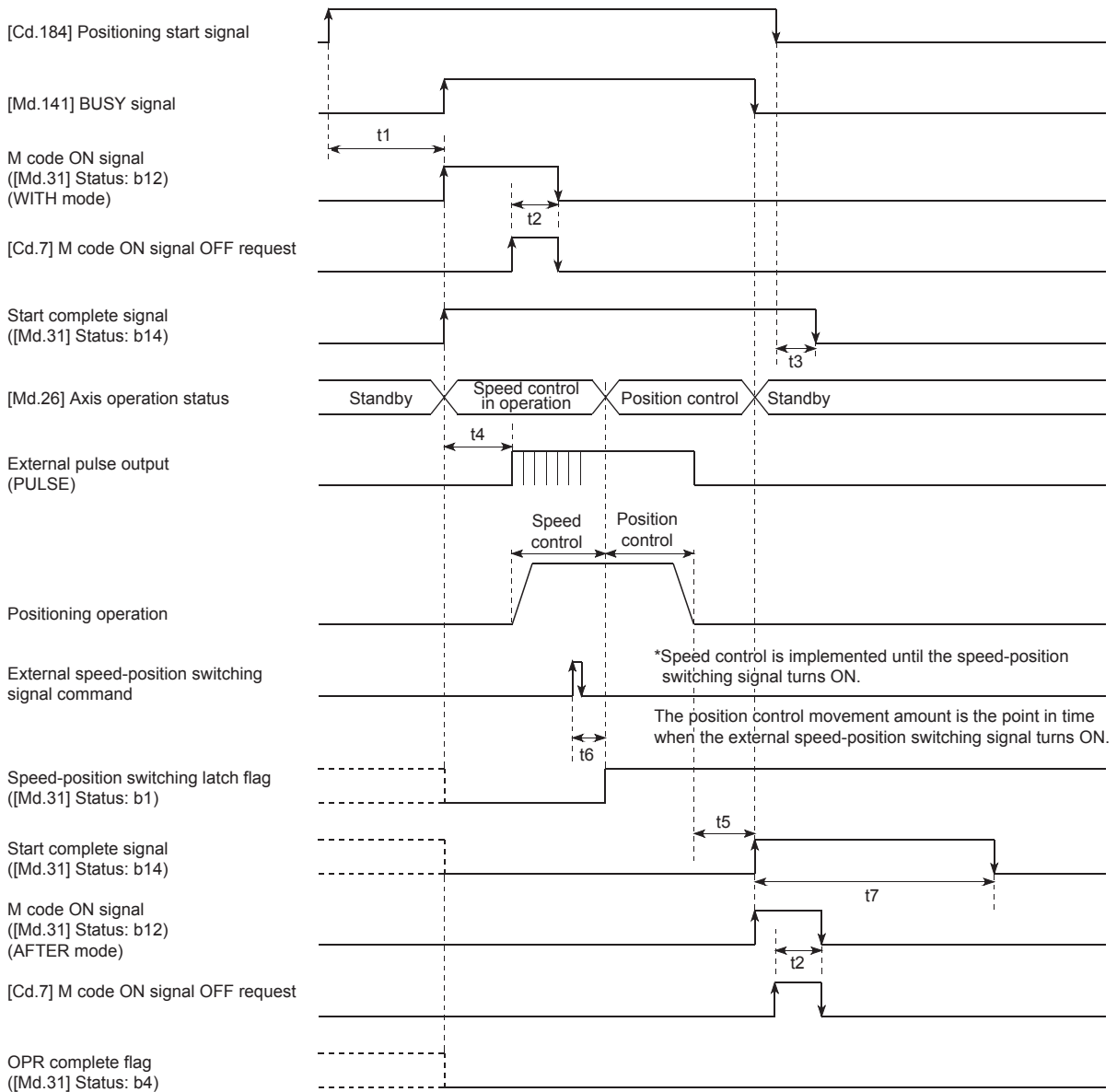

Normal timing time

t1	t2	t3	t4	t5 ^{*1}	t6	t7
0.2 to 0.3 ms	0 to 0.88 ms	0 to 0.88 ms	0.1 ms or less	0 to 0.88 ms	1.0 ms	Depends on the parameter

*1 The timing time of t5 described is the time when 0 is set for the dwell time.

Current feed value

[Md.20] Current feed value during the speed-position switching control (INC mode) depends on the setting of [Pr.21] Current feed value during speed control as described below.

Setting of [Pr.21] Current feed value during speed control	[Md.20] Current feed value
0: Current feed value is not updated	During the speed control, the current feed value at the start of the control is kept. The current feed value is updated when the control is switched to the position control.
1: Update current feed value	The current feed value is updated during both speed control and position control.
2: Current feed value is cleared to zero	The current feed value is cleared to 0 at the start of the control. The current feed value is updated when the control is switched to the position control.

■ If the current feed value is not updated

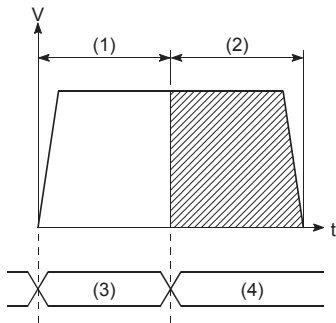

- (1) Speed control
- (2) Position control
- (3) Hold
- (4) Update

■ If updating the current feed value

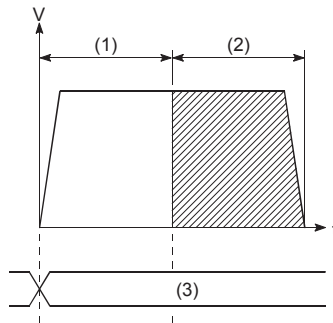

- (1) Speed control
- (2) Position control
- (3) Update

■ If the current feed value is cleared to zero

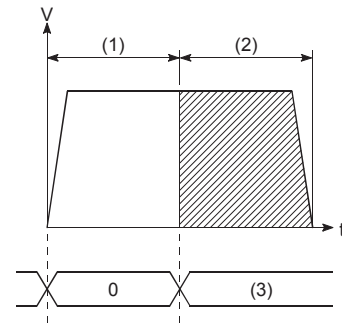

- (1) Speed control
- (2) Position control
- (3) Update from 0.

Time required to switch from speed control → position control

The time taken from when Speed-position switching signal is turned ON to when Speed-position switching latch flag ([Md.31] Status: b1) is turned on is 1 ms.



Movement amount change of the position control

In Speed-position switching control (INC mode), the movement amount of the position control can be changed during the speed control.

- During the speed control, New movement amount is stored in [Cd.23] Speed-position switching control movement amount change register using a program. When Speed-position switching signal is turned on, the movement amount of the position control is stored in [Cd.23] Speed-position switching control movement amount change register.
- At the input timing of Speed-position switching signal, the movement amount of the speed-position switching control (position control) is stored in [Md.29] Speed-position switching control positioning amount.

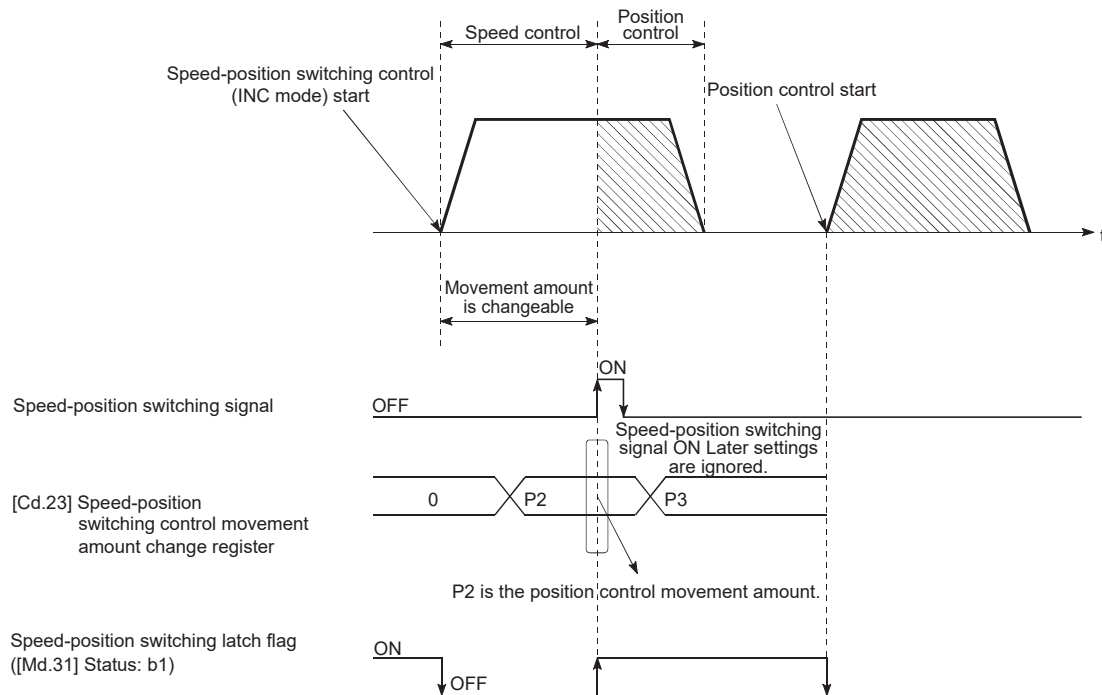

Point

- A change request of the movement amount is recognized by writing data into [Cd.23] Speed-position switching control movement amount change register using a program.
- The timing when the new movement amount becomes valid is from when the speed-position switching control (INC mode) is performed to when Speed-position switching signal is input.
- By using Speed-position switching latch flag ([Md.31] Status: b1) of the axis monitor area, the movement amount change can be enabled and disabled using the interlock function in the position control.

Restrictions

- If "11: Continuous path control" is set in [Da.1] Operation pattern, Continuous path control not possible (Error code: 1A1FH) occurs and the control will not start.
- Speed-position switching control cannot be set in [Da.2] Control method in the positioning data when "11: Continuous path control" is set in [Da.1] Operation pattern of the immediately previous positioning data. (For example, if the operation pattern of the positioning data No.1 is "11: Continuous path control", the speed-position switching control cannot be set to the positioning data No.2.) If this setting is configured, Continuous path control not possible (Error code: 1A20H) occurs and the deceleration stop is implemented.
- If Current speed (-1) is set to [Da.8] Command speed, No command speed (Error code: 1A14H) occurs.
- The software stroke limit range check during the speed control is implemented only when the following 1) and 2) are satisfied.

(1) "[Pr.21] Current feed value during speed control" is "1: Update current feed value".

In any case other than the above, if the movement amount exceeds the software stroke limit range during the speed control, Software stroke limit (+) (Error code: 1A18H) or Software stroke limit (-) (Error code: 1A1AH) occurs and the control decelerates and stops when the control is switched to the position control.

(2) When a value other than "2: degree" is set in "[Pr.1] Unit setting"

When the unit is degree, the software stroke limit range is not checked.

- If the value set in [Da.6] Positioning address/movement amount is negative, Outside address range (Error code: 1A30H) occurs.
- If the movement amount of the position control set in [Da.6] Positioning address/movement amount is smaller than the deceleration distance from [Da.8] Command speed, the deceleration processing is performed when Speed-position switching signal is input.
- Turn ON the speed-position switching signal in the speed stabilization region (in the constant speed state). If the signal is turned ON during the acceleration, the variation of the droop pulse amount becomes large and Speed-position switching signal ON (Warning code: 0993H) occurs. When a servomotor is used, the actual movement amount after the control is switched to the position control is calculated by adding Set movement amount and Droop pulse amount. If the signal is turned on during the acceleration or deceleration, the variation of the droop pulse amount becomes large and the operation stop position varies. Even if the values in [Md.29] Speed-position switching control positioning amount are the same between the two controls, the stop positions change because the droop pulse amount changes when the values in [Da.8] Command speed of both controls differ.
- When a negative value is set in [Cd.23] Speed-position switching control movement amount change register, Insufficient movement amount (Warning code: 0998H) occurs and the movement amount is the value set in [Da.6] Positioning address/movement amount.

Positioning data to be set

To use the speed-position switching control (INC mode), set the following positioning data.

◎: Always set

○: Set as required

—: Setting not required

Setting item		Setting requirement
[Da.1]	Operation pattern	◎
[Da.2]	Control method	◎ (Set Forward run speed-position or Reverse run speed-position.)
[Da.3]	Acceleration time No.	◎
[Da.4]	Deceleration time No.	◎
[Da.5]	Axis to be interpolated	—
[Da.6]	Positioning address/movement amount	◎
[Da.7]	Arc address	—
[Da.8]	Command speed	◎
[Da.9]	Dwell time	○
[Da.10]	M code	○
[Da.27]	M code ON signal output timing	○
[Da.28]	ABS direction in degrees	○
[Da.29]	Interpolation speed specification method	—

For details on the settings, refer to the following.

 Page 423 Positioning Data

Speed-position switching control (ABS mode)

In the speed-position switching control (ABS mode) ([Da.2] Control method = Forward run speed-position, Reverse run speed-position), pulses are output continuously at the speed set in [Da.8] Command speed in the axis direction set to the positioning data. When Speed-position switching signal is input, the position control to the address set in [Da.6] Positioning address/movement amount is implemented.

The speed-position switching control (ABS mode) has two control types including Forward run speed-position implemented in the forward run direction and Reverse run speed-position implemented in the reverse run direction.

The speed-position switching control (ABS mode) is enabled only when 2: degree is set to [Pr.1] Unit setting.

○: Setting possible

×: Setting possible (If set, when "[Cd.190] PLC READY signal" turns ON, a speed-position function selection error (Error code: 1AAEH) occurs.

Speed-position function selection	mm	inch	degree	pulse
INC mode	○	○	○	○
ABS mode	×	×	○	×

The speed-position switching control (ABS mode) can be set to [Pr.150] Speed-position function selection in the detailed parameter 1.

Setting item		Setting value	Setting details	Buffer memory address	
				Axis 1	Axis 2
[Pr.150]	Speed-position function selection	2	Speed-position switching control (ABS mode)	34	184

If a value other than 0 and 2 is set, the control is performed in the INC mode with the setting value regarded as 0.

For details on the settings, refer to the following.

☞ Page 403 [Pr.150] Speed-position function selection

Switching from the speed control→position control

- To switch the speed control to the position control, set Speed-position switching signal as External command signal.
- Select a method to switch from speed control ⇔ position control setting the value of [Cd.45] Speed-position switching device selection.

Setting item		Setting value	Setting details	Buffer memory address	
				Axis 1	Axis 2
[Cd.45]	Speed-position switching device selection	0, 1, 2	Select the device used for speed /position switching. <ul style="list-style-type: none"> • 0: Use External command signal • 1: Use Near-point dog signal • 2: Use "[Cd.46] Speed-position switching command" 	1566	1666

- To switch the speed control to the position control, [Cd.24] Speed-position switching enable flag must be turned on and positioning data must be set. (When "[Cd.24] Speed-position switching enable flag" is turned ON after Speed-position switching signal is turned ON, speed control→position control switching is not implemented. Switches when the speed-position switching signal turns from OFF→ON again. If [Cd.24] Speed-position switching enable flag and External command signal are turned ON at the start of the control, only the position control is implemented.)

Setting item		Setting value	Setting details	Buffer memory address	
				Axis 1	Axis 2
[Cd.24]	Speed-position switching enable flag	0, 1	Set whether to enable or disable Speed-position switching signal. <ul style="list-style-type: none"> • 0: Speed control is not switched to position control even when the speed-position switching signal is turned ON. • 1: Speed control is switched to position control when the speed-position switching signal is turned ON. 	1528	1628

Speed-position switching signal setting

■When External command signal (CHG) is used

To use External command signal (CHG) as a speed-position switching signal, set the following items.

Setting item		Setting value	Setting details	Buffer memory address	
				Axis 1	Axis 2
[Pr.42]	External command function selection	2	Set "2: Speed-position/position-speed switching request".	62	212
[Cd.8]	External command valid	1	Set "1: Validate external command".	1505	1605
[Cd.45]	Speed-position switching device selection	0	Set "0: Use external command signals".	1566	1666

■When Near-point dog signal (DOG) is used

To use Near-point dog signal (DOG) as a speed-position switching signal, set the following items.

Setting item		Setting value	Setting details	Buffer memory address	
				Axis 1	Axis 2
[Cd.45]	Speed-position switching device selection	1	Set "1: Use near-point dog signals".	1566	1666

[Pr.42] External command function selection and [Cd.8] External command valid are not required to be set.

■When [Cd.46] Speed-position switching command is used

To use [Cd.46] Speed-position switching command as Speed-position switching signal, set the following items.

Setting item		Setting value	Setting details	Buffer memory address	
				Axis 1	Axis 2
[Cd.45]	Speed-position switching device selection	2	Set "2: Use [Cd.46] Speed↔position switching commands".	1566	1666

- [Pr.42] External command function selection and [Cd.8] External command valid are not required to be set.
- Compared with the switching control using Speed-position switching signal, the operation delays for 0.88 ms at maximum in the switching control using [Cd.46] Speed-position switching command. If the responsiveness for the switching signal is required, use Speed-position switching signal.

Operation chart

The operation timing of the speed-position switching control (ABS mode) is described below.

During speed control using the speed-position switching control (ABS mode), In speed control flag ([Md.31] Status: b0) is ON.

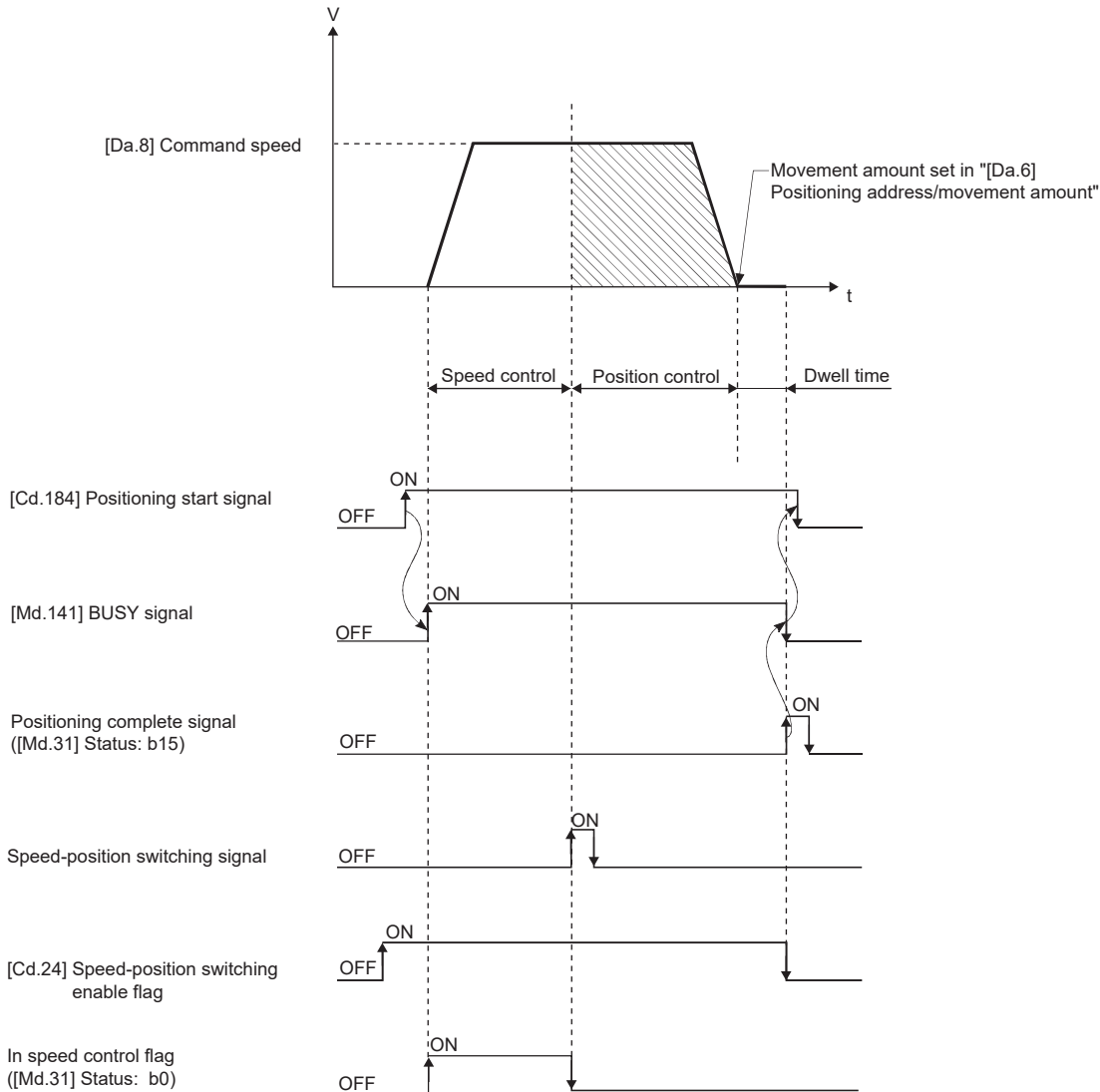

Operation example

The following figure shows the operation when a speed-position switching signal is input at the position where the current feed value is 90.00000 (degree) during the implementation of forward run speed-position in [Da.2] Control method with the settings as follows: [Pr.1] Unit setting is "2: degree" and [Pr.21] Current feed value during speed control is "1: Update current feed value". (The set value of [Da.6] Positioning address/movement amount is 270.00000 (degree).)

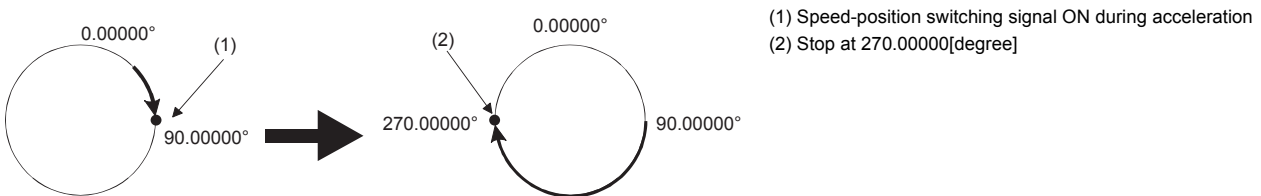

Operation timing and the processing time

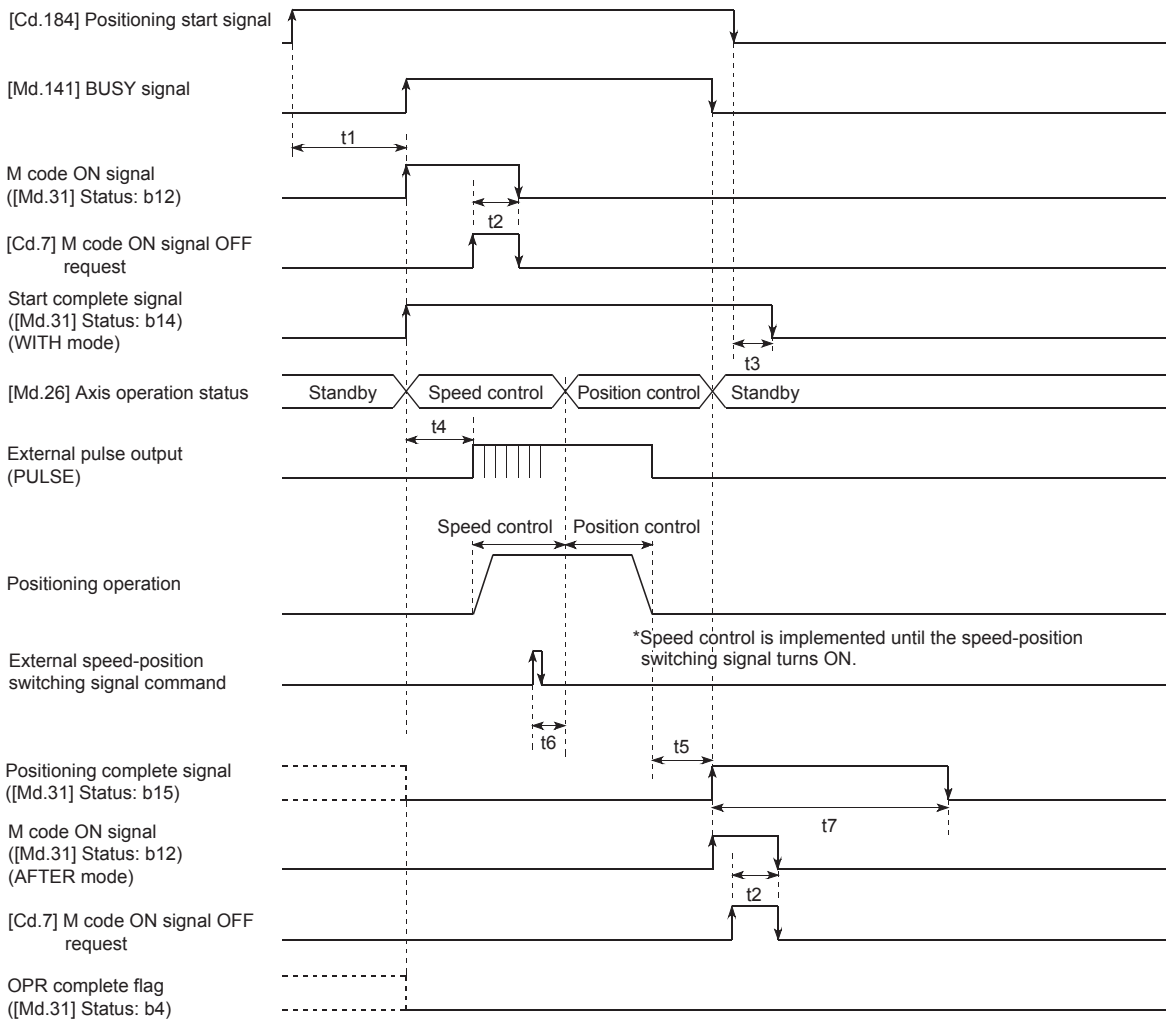

Normal timing time

t1	t2	t3	t4	t5 ^{*1}	t6	t7
0.2 to 0.3 ms	0 to 0.88 ms	0 to 0.88 ms	0.1 ms or less	0 to 0.88 ms	1.0 ms	Depends on the parameter

*1 The timing time of t5 described is the time when 0 is set for the dwell time.

Current feed value

[Md.20] Current feed value during the speed-position switching control (ABS mode) depends on the setting of [Pr.21] Current feed value during speed control as described below.

Setting of [Pr.21] Current feed value during speed control	[Md.20] Current feed value
1: Update current feed value	The current feed value is updated during both speed control and position control.

Only "1: Update current feed value" can be set to [Pr.21] Current feed value during speed control in the speed-position switching control (ABS mode).

If a value other than 1 is set in [Pr.21] Current feed value during speed control, Speed-position function selection error (Error code: 1AAEH) occurs.

■ If updating the current feed value

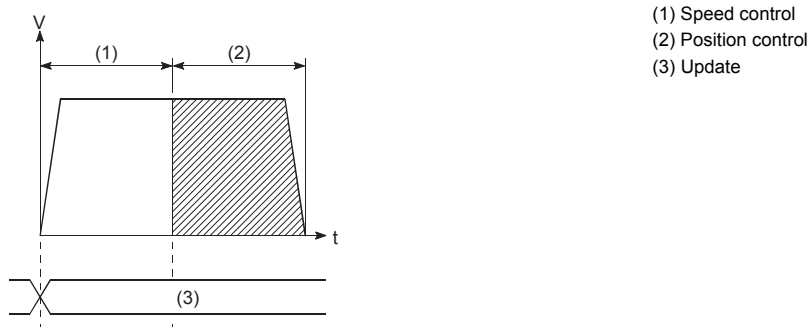

Time required to switch the speed control to the position control

The time taken from when Speed-position switching signal is turned ON to when Speed-position switching latch flag ([Md.31] Status: b1) is turned on is 1 ms.

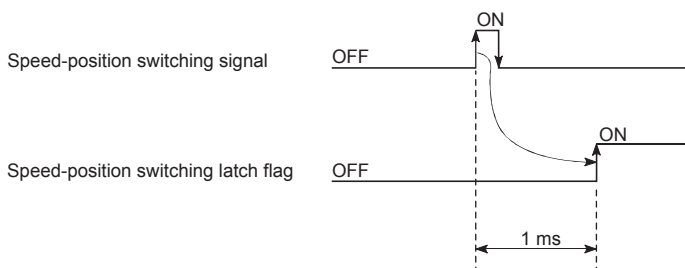

Restrictions

- If "11: Continuous path control" is set in [Da.1] Operation pattern, Continuous path control not possible (Error code: 1A1FH) occurs and the control will not start.
- Speed-position switching control cannot be set in [Da.2] Control method in the positioning data when "11: Continuous path control" is set in [Da.1] Operation pattern of the immediately previous positioning data. (For example, if the operation pattern of the positioning data No.1 is "11: Continuous path control", the speed-position switching control cannot be set to the positioning data No.2.) If this setting is configured, Continuous path control not possible (Error code: 1A20H) occurs and the deceleration stop is implemented.
- If Current speed (-1) is set to [Da.8] Command speed, No command speed (Error code: 1A14H) occurs.
- If the value set in [Da.6] Positioning address/movement amount is negative, Outside address range (Error code: 1A30H) occurs.
- In speed-position switching control (ABS mode), the axis control data [Cd.23] Speed-position switching control movement amount change register is not enabled even if it is set. The set value is ignored.

- To perform the speed-position switching control (ABS mode), the following conditions must be satisfied.
 - (1) "[Pr.1] Unit setting" is "2: degree"
 - (2) The software stroke limit function is disabled (Upper limit value = Lower limit value)
 - (3) "[Pr.21] Current feed value during speed control" is "1: Update current feed value".
 - (4) If the settings range of "[Da.6] Positioning address/movement amount" is 0 to 359.99999 (degrees) or outside the range 0 to 359.99999 (degrees), an outside address range (Error code: 1A31H) error will occur at startup.
 - (5) "[Pr.150] Speed-position function selection" is "2: Speed-position switching control (ABS mode)".
- If (1) to (3) are not satisfied when (5) above is enabled, when "[Cd.190] PLC READY signal" is turned OFF→ON, a speed-position function error (Error code: 1AAEH) will occur.
- The operation does not stop immediately at the positioning address when the positioning target reaches the positioning address during the deceleration even if the automatic deceleration is started after Speed-position switching signal is input. To decelerate automatically, the positioning target stops at the positioning address after the rotation is performed for N (N: natural number) times. In the following example, the positioning target passes the positioning address twice when the deceleration is performed in the dot-line path. Thus, the deceleration stop is performed to stop at the positioning address at the third time.

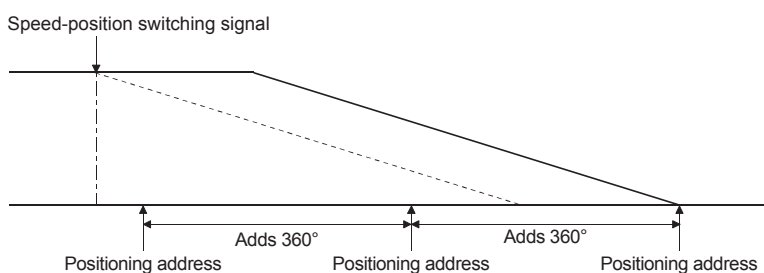

Positioning data to be set

To use the speed-position switching control (ABS mode), set the following positioning data.

◎: Always set

○: Set as required

—: Setting not required

Setting item	Setting requirement
[Da.1] Operation pattern	◎
[Da.2] Control method	◎ (Set Forward run speed-position or Reverse run speed-position.)
[Da.3] Acceleration time No.	◎
[Da.4] Deceleration time No.	◎
[Da.5] Axis to be interpolated	—
[Da.6] Positioning address/movement amount	◎
[Da.7] Arc address	—
[Da.8] Command speed	◎
[Da.9] Dwell time	○
[Da.10] M code	○
[Da.27] M code ON signal output timing	○
[Da.28] ABS direction in degrees	○
[Da.29] Interpolation speed specification method	—

For details on the settings, refer to the following.

📖 Page 423 Positioning Data

Position-speed switching control

In Position-speed switching signal ([Da.2] Control method = Forward run speed-position, Reverse run speed-position), the positioning control for the amount set in [Da.6] Positioning address/movement amount is implemented in the axis direction set to the positioning data before Position-speed switching signal is input. If Position-speed switching signal is input before the positioning is completed, pulses are continuously output at the speed set in [Da.8] Command speed until a stop command is input.

The position-speed switching control has two control types including Forward run position-speed performed in the forward run direction and Reverse run position-speed performed in the reverse run direction.

Switching from the position control to speed control

- Select a method to switch from the speed control to position control setting the value of [Cd.45] Speed-position switching device selection.

Setting item		Setting value	Setting details	Buffer memory address	
				Axis 1	Axis 2
[Cd.45]	Speed-position switching device selection	0, 1, 2	Select the device used for speed /position switching. <ul style="list-style-type: none"> • 0: Use External command signal • 1: Use Near-point dog signal • 2: Use "[Cd.46] Speed-position switching command" 	1566	1666

- To switch the position control to the speed control, [Cd.26] Position-speed switching enable flag must be turned on and positioning data must be set. (When [Cd.26] Position-speed switching enable flag is turned ON after Position-speed switching signal is turned ON, the position control is not switched to the speed control. Switches when the position-speed switching signal turns from OFF→ON again. If [Cd.26] Position-speed switching enable flag and Position-speed switching signal are turned ON at the start, only the speed control is implemented.)

Setting item		Setting value	Setting details	Buffer memory address	
				Axis 1	Axis 2
[Cd.26]	Position-speed switching enable flag	0, 1	Set whether to enable or disable Position-speed switching signal. <ul style="list-style-type: none"> • 0: Position control is not switched to speed control even when Position-speed switching signal is turned ON. • 1: Position control is switched to Speed control when Position-speed switching signal is turned ON. 	1532	1632

- The control decelerates and stops when Position-speed switching signal is not input until the positioning target moves for the movement amount specified in the position control. When Position-speed switching signal is input during the automatic deceleration in the position control, the speed is accelerated again to the command speed the speed control continues.

Position-speed switching signal setting

■When External command signal (CHG) is used

To use External command signal (CHG) as Position-speed switching signal, set the following items.

Setting item		Setting value	Setting details	Buffer memory address	
				Axis 1	Axis 2
[Pr.42]	External command function selection	2	Set "2: Speed-position/position-speed switching request".	62	212
[Cd.8]	External command valid	1	Set "1: Validate external command".	1505	1605
[Cd.45]	Speed-position switching device selection	0	Set "0: Use external command signals".	1566	1666

■When Near-point dog signal (DOG) is used

To use Near-point dog signal (DOG) as Position-speed switching signal, set the following items.

Setting item		Setting value	Setting details	Buffer memory address	
				Axis 1	Axis 2
[Cd.45]	Speed-position switching device selection	1	Set "1: Use near-point dog signals".	1566	1666

[Pr.42] External command function selection and [Cd.8] External command valid are not required to be set.

■When [Cd.46] Speed-position switching command is used

To use [Cd.46] Speed-position switching command as Position-speed switching signal, set the following items.

Setting item		Setting value	Setting details	Buffer memory address	
				Axis 1	Axis 2
[Cd.45]	Speed-position switching device selection	2	Set "2: Use [Cd.46] Speed-position switching command".	1566	1666

[Pr.42] External command function selection and [Cd.8] External command valid are not required to be set.

Operation chart

The following shows the operation timing of the position-speed switching control.

During the speed control with the position-speed switching control, In speed control flag ([Md.31] Status: b0) is ON.

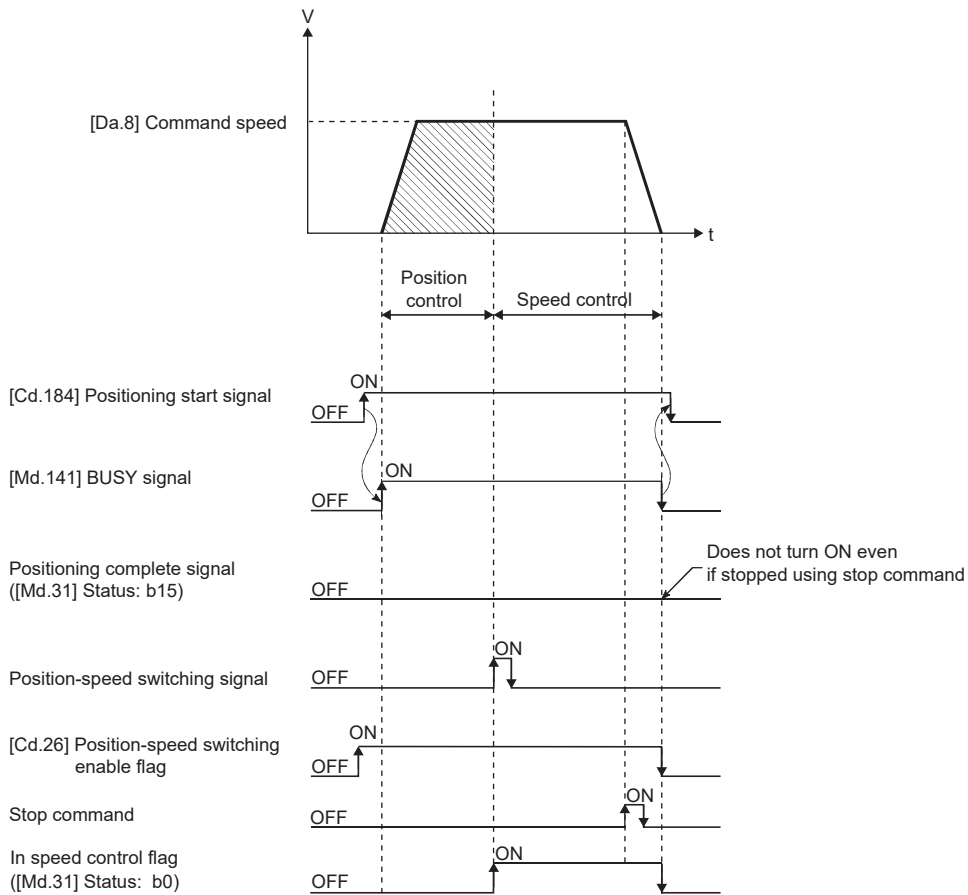

Operation timing and the processing time

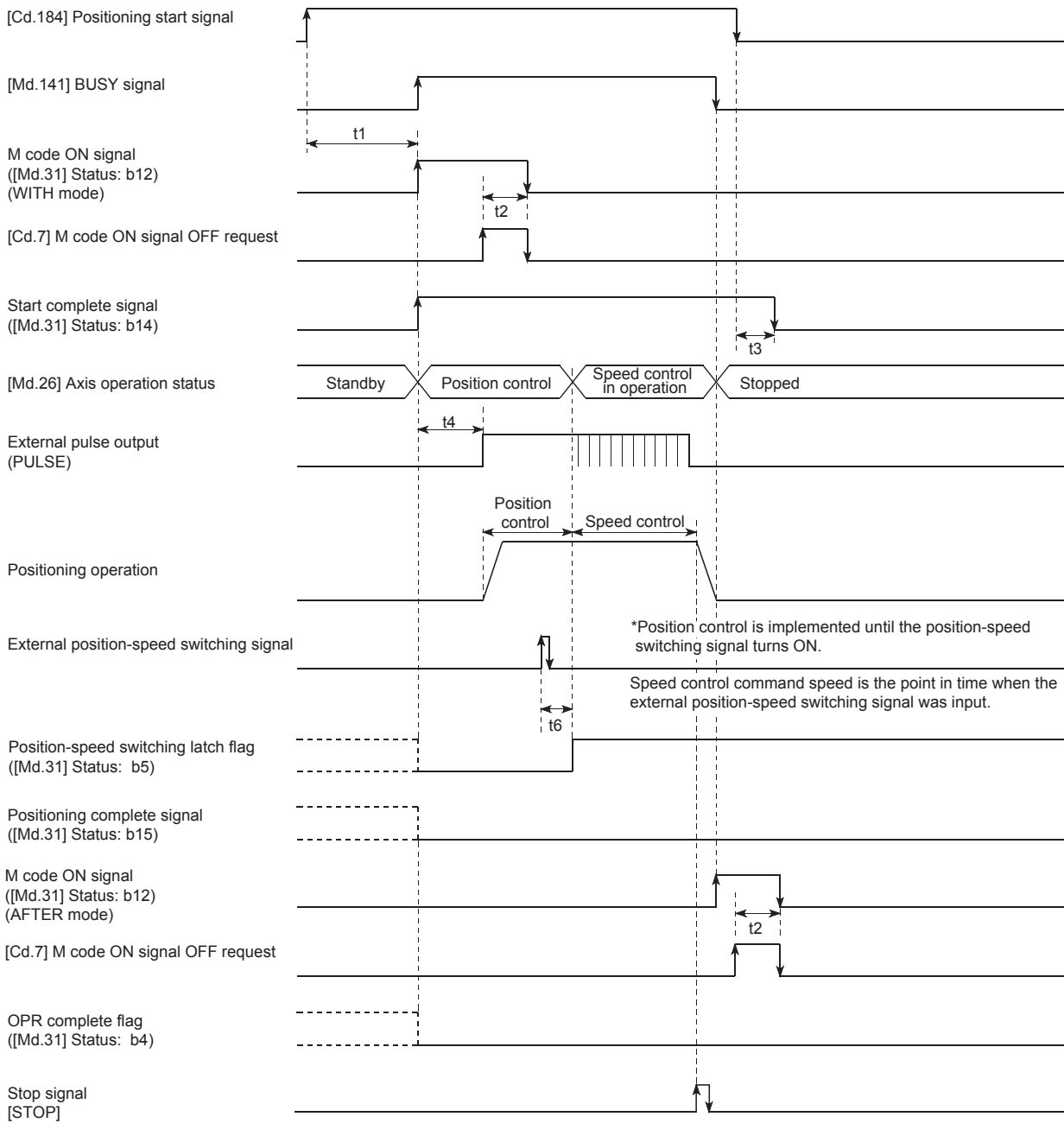

Normal timing time

t1	t2	t3	t4	t5	t6
0.2 to 0.3 ms	0 to 0.88 ms	0 to 0.88 ms	0.1 ms or less	—	1.0 ms

Current feed value

[Md.20] Current feed value during the position-speed switching control depends on the setting of [Pr.21] Current feed value during speed control as follows.

Setting of [Pr.21] Current feed value during speed control	[Md.20] Current feed value
0: Current feed value is not updated	The current feed value is updated during the position control. After the control is switched to the speed control, the current feed value at that point is held.
1: Update current feed value	The current feed value is updated during both position control and speed control.
2: Current feed value is cleared to zero	The current feed value is updated during position control, and the current feed value is then cleared from the moment it is switched to speed control. (Set to 0)

■ If the current feed value is not updated

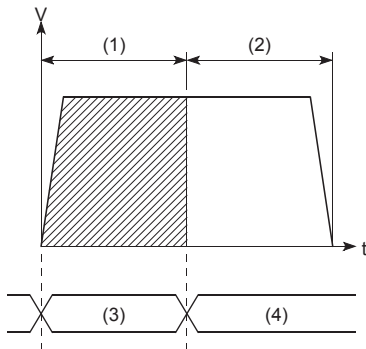

(1) Position control
(2) Speed control
(3) Update
(4) Hold

■ If updating the current feed value

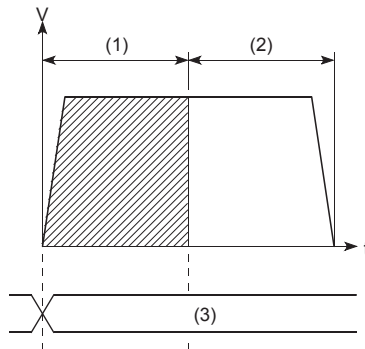

(1) Position control
(2) Speed control
(3) Update

■ If the current feed value is cleared to zero

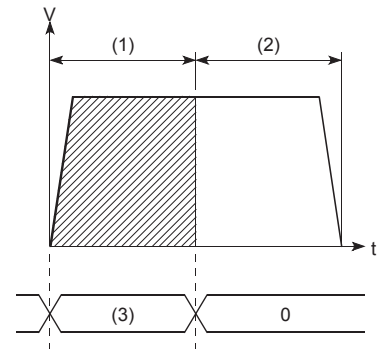

(1) Position control
(2) Speed control
(3) Update

Time taken for switching from position control → speed control

The time taken from when Position-speed switching signal is turned ON to when Position-speed switching latch flag ([Md.31] Status: b5) is turned ON is 1 ms.



Changing the command speed of the speed control

In Position-speed switching control, the command speed of the speed control can be changed during the position control.

- When the command speed change is requested during the control other than the position control of the position-speed switching control, the change request is ignored.
- During the position control, New command speed is stored in [Cd.25] Position-speed switching control speed change register using a program. When Position-speed switching signal is turned on, the setting of [Cd.25] Position-speed switching control speed change register becomes the command speed of the speed control.

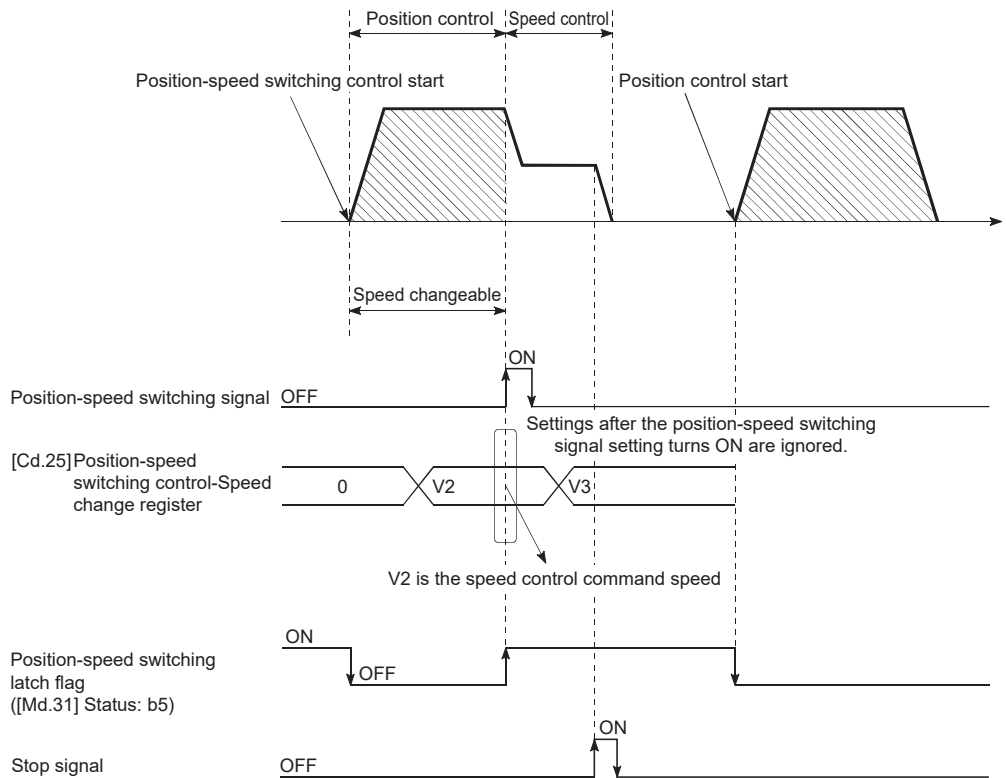

Point

- A change request of the command speed is recognized by writing data into [Cd.25] Position-speed switching control speed change register using a program.
- The timing when the new command speed becomes valid is from when the position-speed switching control is performed to when Position-speed switching signal is input.
- By using Position-speed switching latch flag ([Md.31] Status: b5) of the axis monitor area, the speed change can be enabled and disabled using the interlock function in the speed control.

Restrictions

- If "01: Continuous positioning control" or "11: Continuous path control" is set in [Da.1] Operation pattern, Continuous path control not possible (Error code: 1A1EH, 1A1FH) occurs and the control will not start.
- Position-speed switching control cannot be set to [Da.2] Control method of the positioning data when "11: Continuous path control" is set to [Da.1] Operation pattern of the previous positioning data. For example, if the operation pattern of the positioning data No.1 is "11: Continuous path control", Position-speed switching control cannot be set to the positioning data No.2. If this setting is configured, Continuous path control not possible (Error code: 1A20H) occurs and the deceleration stop is implemented.
- The software stroke limit range during the speed control is checked only when "1: Update current feed value" is set to [Pr.21] Current feed value during speed control. When the unit is degree, the software stroke limit check range is not checked.
- If the start point address of the position control exceeds the software stroke limit range, Software stroke limit (+) (Error code: 1A18H) or Software stroke limit (-) (Error code: 1A1AH) occurs and the operation will not start.
- If the end point address of the position control exceeds the software stroke limit range, Software stroke limit (+) (Error code: 1A18H) or Software stroke limit (-) (Error code: 1A1AH) occurs and the operation will not start.
- The control decelerates and stops when Position-speed switching signal is not input until the positioning target moves for the movement amount specified. When Position-speed switching signal is input during the automatic deceleration in the position control, the speed is accelerated again to the command speed the speed control continues. When Position-speed switching signal is input during the deceleration stop by Stop signal, the control is switched to the speed control and stops. Restart the speed control using a restart command.
- If the changed command speed is equal to or greater than the value set in [Pr.8] Speed limit value, Speed limit value over (Warning code: 0991H) occurs and the control continues at the speed set in [Pr.8] Speed limit value.
- If the value set in [Da.6] Positioning address/movement amount is negative, Outside address range (Error code: 1A30H) occurs.

Positioning data to be set

To use the position-speed switching control, set the following positioning data.

◎: Always set

○: Set as required

—: Setting not required

Setting item	Setting requirement
[Da.1] Operation pattern	◎
[Da.2] Control method	◎ (Set Forward run position-speed or Reverse run position-speed.)
[Da.3] Acceleration time No.	◎
[Da.4] Deceleration time No.	◎
[Da.5] Axis to be interpolated	—
[Da.6] Positioning address/movement amount	◎
[Da.7] Arc address	—
[Da.8] Command speed	◎
[Da.9] Dwell time	○
[Da.10] M code	○
[Da.27] M code ON signal output timing	○
[Da.28] ABS direction in degrees	○
[Da.29] Interpolation speed specification method	—

For details on the settings, refer to the following.

 Page 423 Positioning Data

Current value change

In the current value change, the value in [Md.20] Current feed value of the stopping axis is changed to an address. (The value in [Md.21] Machine feed value is not changed even if the current value is changed.)

One of the following two methods can be used for changing the current value.

- When the current value is changed using positioning data
- When the current value is changed using the start No. for a current value change (No.9003)

The positioning data can be used during the continuous positioning of multiple blocks.

When the current value is changed using positioning data

In Current value change ([Da.2] Control method = Current value change), the value in [Md.20] Current feed value is changed to the address set in [Da.6] Positioning address/movement amount.

■Operation chart

The following shows the operation timing of the current value change. When Positioning start signal is turned on, the value in [Md.20] Current feed value is changed to the value set in [Da.6] Positioning address/movement amount.

Ex.

If the positioning address is changed to "0"

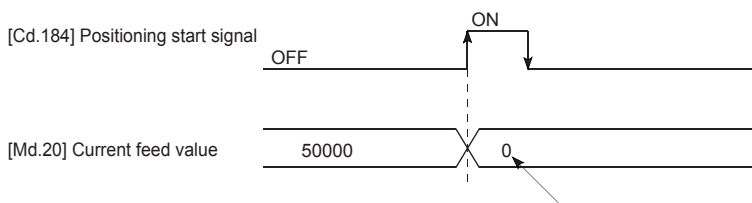

Changes to the positioning address specified using the new current value positioning data

■Restrictions

- If "11: Continuous path control" is set in [Da.1] Operation pattern, New current value not possible (Error code: 1A1CH) occurs and the control will not start. (In the current value change, "11: Continuous path control" be set.)
- Current value change cannot be set in [Da.2] Control method in the positioning data when "11: Continuous path control" is set in [Da.1] Operation pattern of the previous positioning data. (For example, if the operation pattern of the positioning data No.1 is "11: Continuous path control", Current value change cannot be set to the positioning data No.2.) If this setting is configured, New current value not possible (Error code: 1A1DH) occurs and deceleration stops.
- When "2: degree" is set in [Pr.1] Unit setting and the value set in [Da.6] Positioning address/movement amount is out of the setting range (0 to 359.99999 [degree]), Outside new current value range (Error code: 1997H) occurs and the operation will not start.
- If the value set in [Da.6] Positioning address/movement amount is out of the setting range of the software stroke limit ([Pr.12], [Pr.13]), Software stroke limit (+) (Error code: 1A18H) or Software stroke limit (-) (Error code: 1A1AH) occurs and the operation will not start.

■Positioning data to be set

To use the current value change, set the following positioning data.

◎: Always set

○: Set as required

—: Setting not required

Setting item	Setting requirement
[Da.1] Operation pattern	◎
[Da.2] Control method	◎ (Set Current value change.)
[Da.3] Acceleration time No.	—
[Da.4] Deceleration time No.	—
[Da.5] Axis to be interpolated	—
[Da.6] Positioning address/movement amount	◎ (Set the address to be changed.)
[Da.7] Arc address	—
[Da.8] Command speed	—
[Da.9] Dwell time	—
[Da.10] M code	○
[Da.27] M code ON signal output timing	○
[Da.28] ABS direction in degrees	—
[Da.29] Interpolation speed specification method	—

For details on the settings, refer to the following.

📖 Page 423 Positioning Data

When the current value is changed using the start No. for a current value change (No.9003)

In Current value change ([Cd.3] Positioning start No. = 9003), [Md.20] Current feed value is changed to the address set in [Cd.9] New current value.

■Operation chart

The current value is changed by turning on Positioning start signal after the new current value is set in [Cd.9] New current value and 9003 is set in [Cd.3] Positioning start No.

Ex.

If the positioning address is changed to "0"

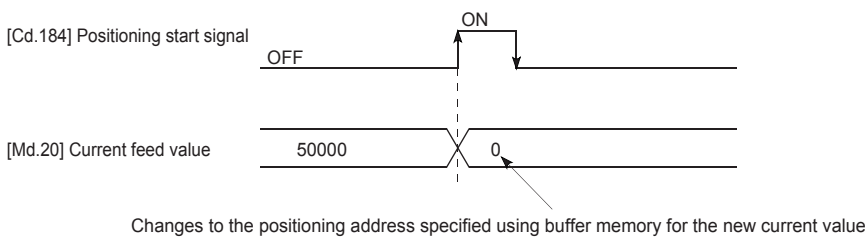

■Restrictions

- When the unit setting is degree and the specified value is out of the setting range, Outside new current value range (Error code: 1997H) occurs.
- If the specified value is out of the software stroke limit range, Software stroke limit (+) (Error code: 1994H) or Software stroke limit (-) (Error code: 1996H) occurs.
- The current value cannot be changed while the stop command and M code ON signal are on.
- The M code output function is invalid.

■Procedure

The following shows the procedure for executing the current value change.

1. Write the current value to "[Cd.9] New current value"
2. Write [9003] to "[Cd.3] Positioning start No."
3. Turn ON the positioning start signal

■Setting method

The following shows the data setting and a program example for executing the current value change using Positioning start signal. ([Md.20] Current feed value is changed to 5000.0 μm.)

(1) Settings data

Set the following data.

Setting item		Setting value	Setting details	Buffer memory address	
				Axis 1	Axis 2
[Cd.3]	Positioning start No.	9003	Sets 9003, the start No. for a current value change.	1500	1600
[Cd.9]	New current value	50000	Set [Md.20] Current feed value after the change.	1506	1606
				1507	1607

(2) Time chart

The following shows the start time chart.

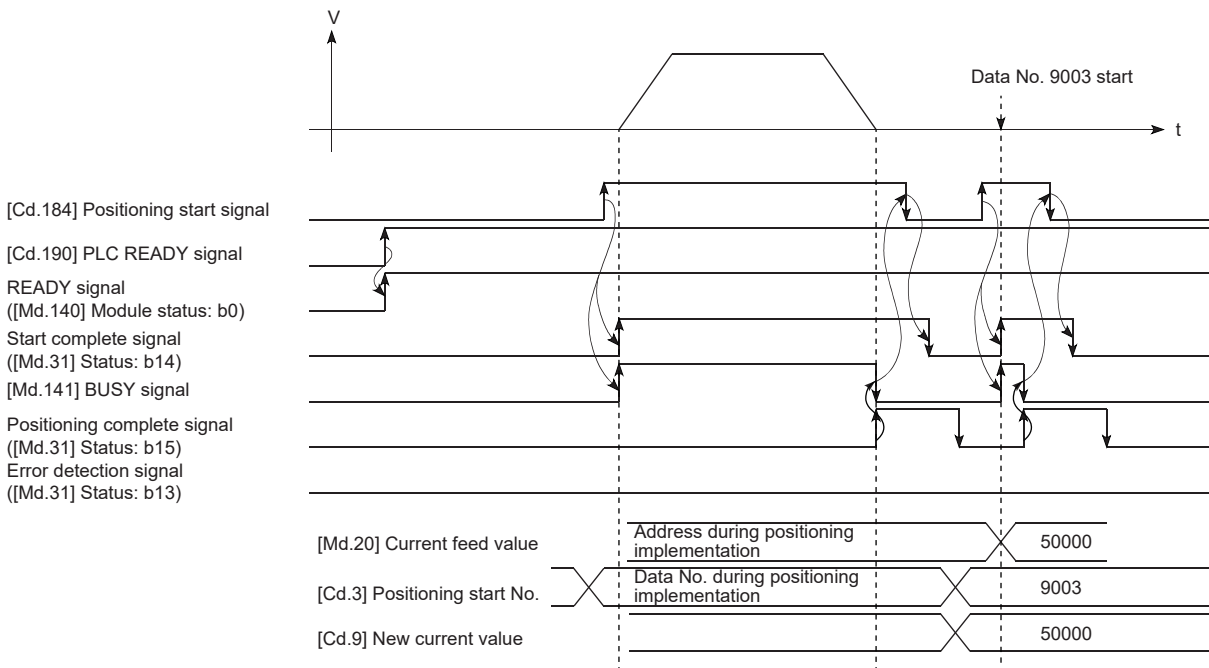

(3) Program example

Add the following program to the control program, and write it to the CPU module.

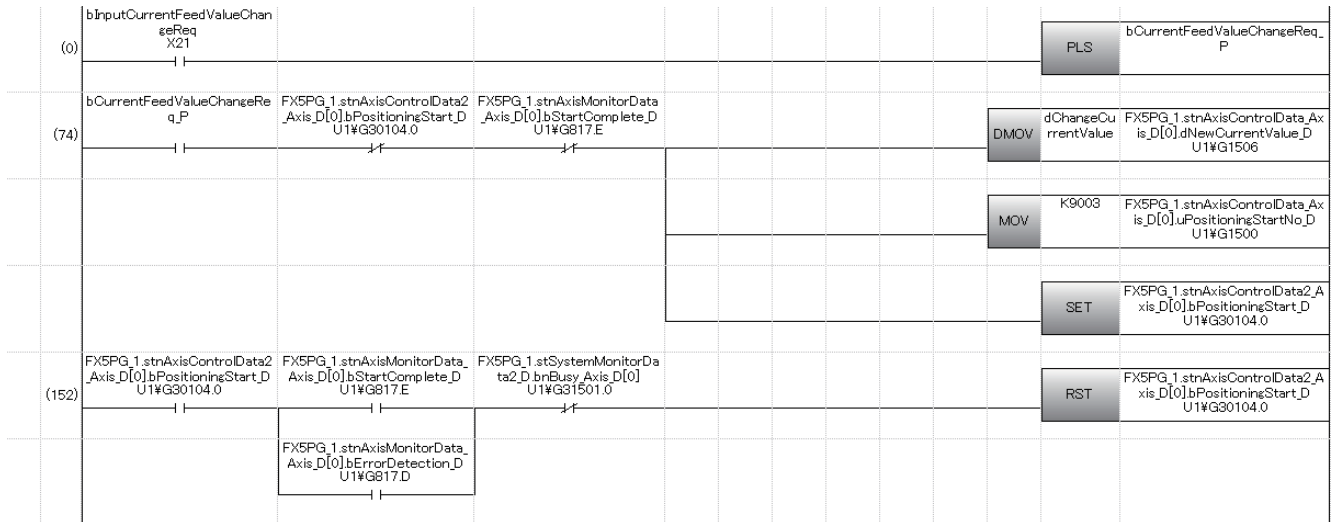

Classification	Label Name	Description												
Module label	FX5PG_1.stnAxisMonitorData_Axis_D[0].bErrorDetection_D	Axis 1 Error detection signal												
	FX5PG_1.stSystemMonitorData2_D.bnBusy_Axis_D[0]	Axis 1 BUSY signal												
	FX5PG_1.stnAxisMonitorData_Axis_D[0].bStartComplete_D	Axis 1 Start complete signal												
	FX5PG_1.stnAxisControlData2_Axis_D[0].bPositioningStart_D	Axis 1 Positioning start signal												
	FX5PG_1.stnAxisControlData_Axis_D[0].uPositioningStartNo_D	Axis 1 Positioning start No.												
	FX5PG_1.stnAxisControlData_Axis_D[0].dNewCurrentValue_D	Axis 1 New current value												
Global label, local label	Define the global label or local label as follows. Setting Assign (Device/Label) for labels is not necessary because the unused internal relay and data device are automatically assigned to the labels.													
	<table border="1"> <thead> <tr> <th></th> <th>Label Name</th> <th>Data Type</th> <th>Class</th> </tr> </thead> <tbody> <tr> <td>1</td> <td>bCurrentFeedValueChangeReq_P</td> <td>Bit</td> <td>... VAR</td> </tr> <tr> <td>2</td> <td>dChangeCurrentValue</td> <td>Double Word [Signed]</td> <td>... VAR</td> </tr> </tbody> </table>		Label Name	Data Type	Class	1	bCurrentFeedValueChangeReq_P	Bit	... VAR	2	dChangeCurrentValue	Double Word [Signed]	... VAR	
	Label Name	Data Type	Class											
1	bCurrentFeedValueChangeReq_P	Bit	... VAR											
2	dChangeCurrentValue	Double Word [Signed]	... VAR											
	<table border="1"> <thead> <tr> <th></th> <th>Label Name</th> <th>Data Type</th> <th>Class</th> <th>Assign (Device/Label)</th> </tr> </thead> <tbody> <tr> <td>18</td> <td>bInputCurrentFeedValueChangeReq</td> <td>Bit</td> <td>... VAR_GLOBAL</td> <td>X21</td> </tr> </tbody> </table>		Label Name	Data Type	Class	Assign (Device/Label)	18	bInputCurrentFeedValueChangeReq	Bit	... VAR_GLOBAL	X21			
	Label Name	Data Type	Class	Assign (Device/Label)										
18	bInputCurrentFeedValueChangeReq	Bit	... VAR_GLOBAL	X21										

NOP instruction

The NOP instruction is a control method that is not executed.

Operation

The positioning data No. to which the NOP instruction is set is not processed and the operation is shifted to the one of the next positioning data No.

Point

[Application example of the NOP instruction]

If the speed switching or the operation suspension (automatic deceleration) may be implemented during the positioning operation between two points in the future, the data can be reserved using the NOP instruction and can be changed only by replacing the identifier.

Positioning data to be set

To use the NOP instruction, set the following positioning data.

◎: Always set

○: Set as required

—: Setting not required

Setting item	Setting requirement
[Da.1] Operation pattern	—
[Da.2] Control method	◎(Sets NOP commands.)
[Da.3] Acceleration time No.	—
[Da.4] Deceleration time No.	—
[Da.5] Axis to be interpolated	—
[Da.6] Positioning address/movement amount	—
[Da.7] Arc address	—
[Da.8] Command speed	—
[Da.9] Dwell time	—
[Da.10] M code	—
[Da.27] M code ON signal output timing	—
[Da.28] ABS direction in degrees	—
[Da.29] Interpolation speed specification method	—

For details on the settings, refer to the following.

 Page 423 Positioning Data

Restrictions

When the NOP instruction is set as the control method of the positioning data No.600, Control method setting error (Error code: 1A26H) occurs.

JUMP instruction

The JUMP instruction is used to jump to the positioning data No. set in the positioning data during Continuous positioning control or Continuous path control.

The following two JUMP instructions can be used.

JUMP instruction	Description
Unconditional JUMP	When no execution condition is set for the JUMP instruction (when 0 is set as the condition data No.)
Conditional JUMP	When implementation conditions are set for the JUMP instruction (The conditions are set in the condition data used with Advanced positioning control.)

By using the JUMP instruction, implementing the same positioning control repeatedly and selecting positioning data No. or implementation conditions are enabled when Continuous positioning control or Continuous path control is performed.

Operation

■When the unconditional JUMP is used

The JUMP instruction is unconditionally executed and the operation jumps to the positioning data No. set in [Da.9] Dwell time.

■When the conditional JUMP is used

The block start condition data is used as the execution condition of the JUMP instruction.

- When block positioning data (No.7000 to 7004) is started, the condition data of each block is used.
- When the positioning data No.1 to 600 are started, the condition data of the start block 0 is used.
- If the implantation condition set in [Da.10] M code of the JUMP instruction is satisfied, the JUMP instruction is implemented to jump to the positioning data No. set in [Da.9] Dwell time.
- If the execution condition set in [Da.10] M code of the JUMP instruction is not satisfied, the JUMP instruction is ignored and the next positioning data No. is executed.

Restrictions

- When using a conditional JUMP instruction, establish the execution conditions of the JUMP instruction by when the positioning data whose number is four number before the positioning data No. of the JUMP instruction is executed. If the execution conditions of the JUMP instruction are not established by the time, the processing for when execution conditions are not established is performed. (During the implementation of the continuous path control or continuous positioning control, it will calculate the positioning data of the positioning data No. four items after the current positioning data.)
- The positioning control such as the one keeps looping until the conditions are satisfied cannot be implemented only using the conditional JUMP instruction. For the target of the JUMP instruction, specify the positioning data whose control method is other than the JUMP instruction and NOP instruction.

Positioning data to be set

To use the JUMP instruction, set the following positioning data.

◎: Always set

○: Set as required

—: Setting not required

Setting item		Setting requirement
[Da.1]	Operation pattern	—
[Da.2]	Control method	◎ (Set the JUMP instruction.)
[Da.3]	Acceleration time No.	—
[Da.4]	Deceleration time No.	—
[Da.5]	Axis to be interpolated	—
[Da.6]	Positioning address/movement amount	—
[Da.7]	Arc address	—
[Da.8]	Command speed	—
[Da.9]	Dwell time	◎ (Set the positioning data No.1 to 600 of the target of the JUMP instruction.)
[Da.10]	M code	◎ (Set the implementation condition of the JUMP instruction with a condition data No. as described below. 0: Unconditional JUMP, 1 to 10: Condition data No. (The condition data for simultaneous start cannot be set.))
[Da.27]	M code ON signal output timing	—
[Da.28]	ABS direction in degrees	—
[Da.29]	Interpolation speed specification method	—

For details on the settings, refer to the following.

 Page 423 Positioning Data

LOOP

The loop control with repetition of the LOOP to LEND instructions is implemented.

Operation

The loop of LOOP to LEND is repeated for the set number of the repetition.

Positioning data to be set

To use the LOOP instruction, set the following positioning data.

- ◎: Always set
- : Set as required
- : Setting not required

Setting item	Setting requirement
[Da.1]	Operation pattern —
[Da.2]	Control method ◎ (Set LOOP.)
[Da.3]	Acceleration time No. —
[Da.4]	Deceleration time No. —
[Da.5]	Axis to be interpolated —
[Da.6]	Positioning address/movement amount —
[Da.7]	Arc address —
[Da.8]	Command speed —
[Da.9]	Dwell time —
[Da.10]	M code ◎ (Sets the number of repetitions.)
[Da.27]	M code ON signal output timing —
[Da.28]	ABS direction in degrees —
[Da.29]	Interpolation speed specification method —

For details on the settings, refer to the following.

 Page 423 Positioning Data

Restrictions

- If 0 is set for the number of repetitions, a control method LOOP setting error (Error code: 1A33H) occurs.
- Although the error does not occur even if LEND is not set after LOOP, the repetition is not processed.
- The nesting between LOOP and LEND cannot be set. If the nesting is set, only the inner LOOP to LEND are processed repeatedly.

Point

The setting becomes easier than the special start FOR (times) by setting required items in the control method. ( Page 184 Repeated start (FOR loop))

- Special start: Positioning start data, special start data, condition data, and positioning data
- Control method: Positioning data

For the special start FOR to NEXT, positioning data is required for each point of FOR and NEXT, but the loop is available with only one data in the control method.

Nesting is available by combining the control method LOOP to LEND and the special start FOR to NEXT. However, LOOP to LEND cannot be set across the blocks. Set the processing of LOOP to LEND to be finished in one block.

For details on Block, refer to the following.

 Page 174 ADVANCED POSITIONING CONTROL

LEND

The operation is returned to the head of the repeating loop (LOOP to LEND).

Operation

The loop is completed when the number of repetition specified in LOOP is 0 and the processing of the next positioning data No. is executed. (Even if the operation pattern is set to "Positioning complete", the setting is ignored.)

To stop the operation after the implementation for the specified number of repetitions, set a dummy positioning data (for example, the positioning in the incremental system whose movement amount is 0).

The following table shows the operation for when Positioning complete (00) is set to LOOP and LEND.

Positioning data No.	Operation pattern	Control method	Condition	Operation
1	Continuous control	ABS2		Positioning data is implemented in the order of No.1 → 2 → 3 → 4 → 5 → 2 → 3 → 4 → 5 → 6. (The operation patterns of the positioning data No. 2 and 5 are ignored.)
2	Positioning Complete	LOOP	Loop count: 2	
3	Continuous path control	ABS2		
4	Continuous control	ABS2		
5	Positioning Complete	LEND		
6	Positioning Complete	ABS2		

Positioning data to be set

To use the LEND instruction, set the following positioning data.

- ◎: Always set
- : Set as required
- : Setting not required

Setting item	Setting requirement
[Da.1] Operation pattern	—
[Da.2] Control method	◎ (Set LEND.)
[Da.3] Acceleration time No.	—
[Da.4] Deceleration time No.	—
[Da.5] Axis to be interpolated	—
[Da.6] Positioning address/movement amount	—
[Da.7] Arc address	—
[Da.8] Command speed	—
[Da.9] Dwell time	—
[Da.10] M code	—
[Da.27] M code ON signal output timing	—
[Da.28] ABS direction in degrees	—
[Da.29] Interpolation speed specification method	—

For details on the settings, refer to the following.

 Page 423 Positioning Data

Restrictions

- The LEND before the execution of LOOP is ignored.
- If the operation pattern Positioning complete is set between LOOP and LEND, the positioning control is completed after the implementation of that positioning data and the loop control is not performed.

10 ADVANCED POSITIONING CONTROL

This chapter describes the details and usage of the advanced positioning control (the control function using Block start data). The advanced positioning control is used to implement applied controls using Positioning data, and examples of the applied controls use the condition judgment to control the positioning data set using the major positioning control, or start positioning data for multiple axes simultaneously.

Check the settings and execution procedures for each control, and configure each setting as required.

10.1 Overview of Advanced Positioning Control

For Advanced positioning control, the execution order and execution conditions of Positioning data are set to execute further applied positioning. (The implementation order and execution conditions are set in the block start data and condition data.) The following types of applied positioning controls can be implemented using advanced positioning control.

Advanced positioning control	Description
Block ^{*1} start (normal start)	With one start, executes positioning data in a block in the set order.
Condition start	Judges the condition set in Condition data for the specified positioning data, and executes Block start data. <ul style="list-style-type: none">• When the condition is established, Block start data is executed.• When not established, that block start data is ignored, and the block start data of the next point is executed.
Wait start	Judges the condition set in Condition data for the specified positioning data, and executes Block start data. <ul style="list-style-type: none">• When the condition is established, Block start data is executed.• When not established, the control stops (waits) until the condition is established.
Simultaneous start ^{*2}	Simultaneously implements the positioning data for the axes specified using condition data (outputs pulses at the same timing).
Repeated start (FOR loop)	Repeats the program from the block start data set with FOR loop to the block start data set in NEXT for the specified number of times.
Repeated start (FOR condition)	Repeats the program from the block start data set with FOR condition to the block start data set in NEXT until the conditions set in the condition data are established.

*1 1 block is defined as all the data continuing from the positioning data in which continuous positioning control or continuous path control is set in [Da. 1] Operation pattern to the positioning data in which Independent positioning control (Positioning complete) is set.

*2 Besides the simultaneous start using Block start data, Multiple axes simultaneous start control of the control system is included.

 Page 71 Multiple axes simultaneous start

Sub functions for advanced positioning control

Advanced positioning control uses Positioning data set with Major positioning control.

For details on the sub functions that can be combined with the major positioning control, refer to the following.

 Page 34 Combining Main and Sub Functions

Note that the pre-reading start function cannot be used together with Advanced positioning control.

Advanced positioning control from GX Works3

Advanced positioning control (start of block start data) can be implemented using the positioning test in the GX Works3. For details on the positioning test, see the following.

 Page 340 Positioning Test

Data required for advanced positioning control

Advanced positioning control is performed by setting the required items in Block start data and Condition data, and starting the block start data. Whether or not the operations can be executed is judged at the execution of the control according to the condition data specified in the block start data.

- Block start data can be set for each number from 7000 to 7004 (called block No.), and up to 50 points can be set for each axis. (This data is controlled with numbers called Points to distinguish it from the positioning data. For example, the 1st point block start data item is called 1st point block start data or Point No. 1 block start data.)
- Condition data can be set for each number from 7000 to 7004 (called block No.), and up to 10 data items can be set for each block number.

Block start data and Condition data are set as one for each block No.

The following table shows the overview of the block start data and condition data stored in the positioning module.

Setting item			Setting detail
Block start data	[Da.11]	Shape	Set whether to end the control after only the block start data of the shape itself is executed, or to continue executing the block start data set in the next point.
	[Da.12]	Start data No.	Set Positioning data No. to be executed.
	[Da.13]	Special start instruction	Set the method by which the positioning data set in [Da.12] will be started.
	[Da.14]	Parameter	Set the conditions by which the start will be executed according to the commands set in [Da.13]. (Specify Condition data No. or No. of repetitions.)
Condition data	[Da.15]	Condition target	Select Device, Stored contents in buffer memory, and Positioning data No. elements for which the conditions are set.
	[Da.16]	Condition operator	Set the judgment method performed for the target set in [Da.15].
	[Da.17]	Address	Set the buffer memory address in which the condition judgment is performed (only when the element set in [Da.15] is Stored contents in buffer memory).
	[Da.18]	Parameter 1	Set the required conditions according to the elements set in [Da.15] and [Da.16].
	[Da.19]	Parameter 2	Set the required conditions according to the elements set in [Da.15] and [Da.16].

Block start data and Condition data configurations

Block start data and Condition data corresponding to Block No. 7000 to 7004 can be stored in the buffer memory. (The following table shows an example for Axis 1.)

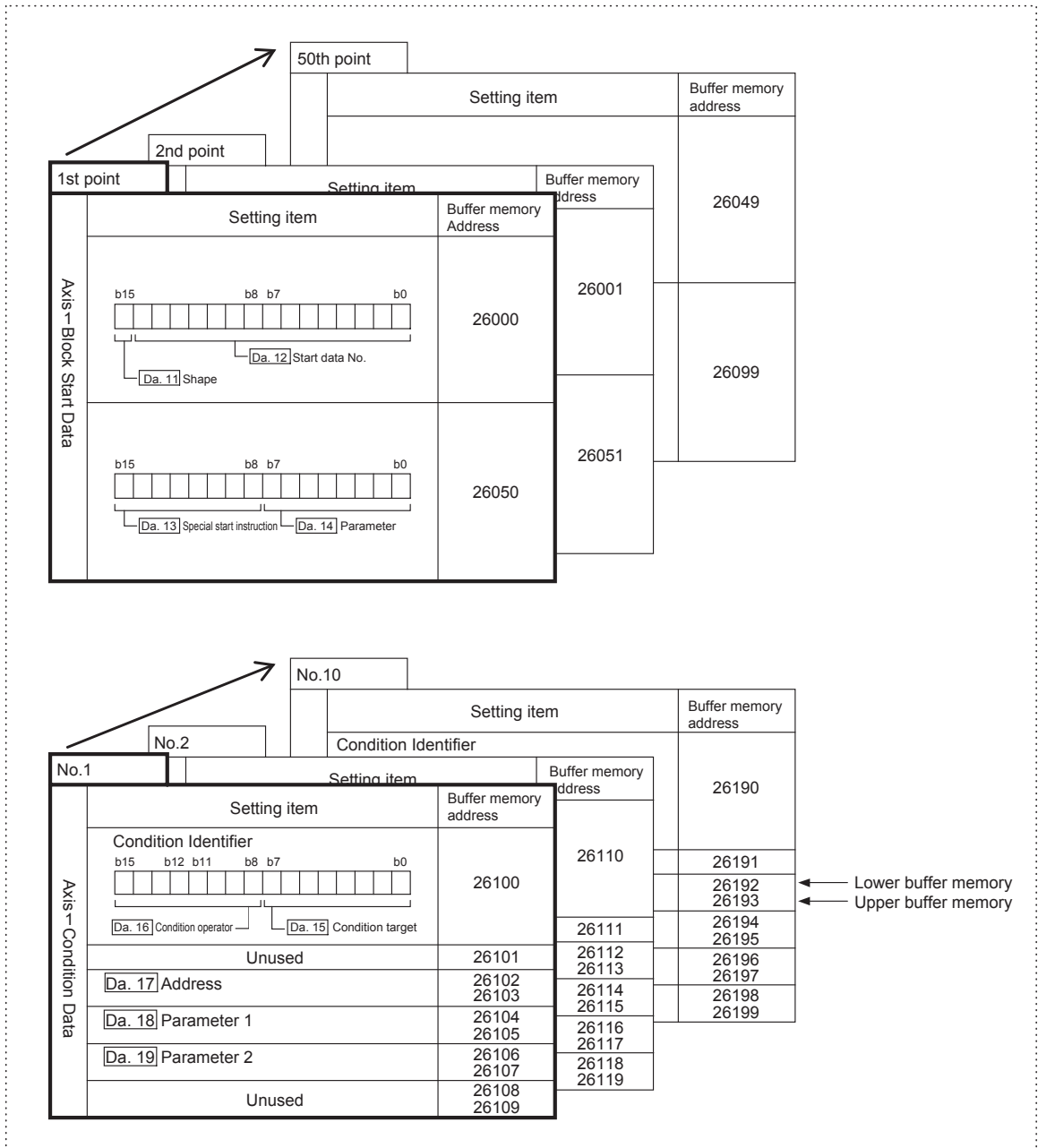

(Same as for Axis 2)

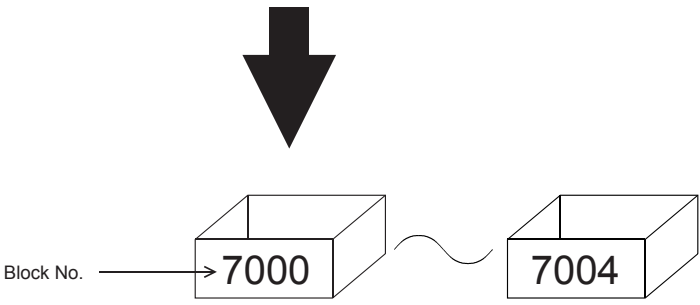

Set the positioning module using either GX Works3 or the program.

10.2 Implementation Procedure for Advanced Positioning Control

The advanced positioning control is performed using the following procedure.

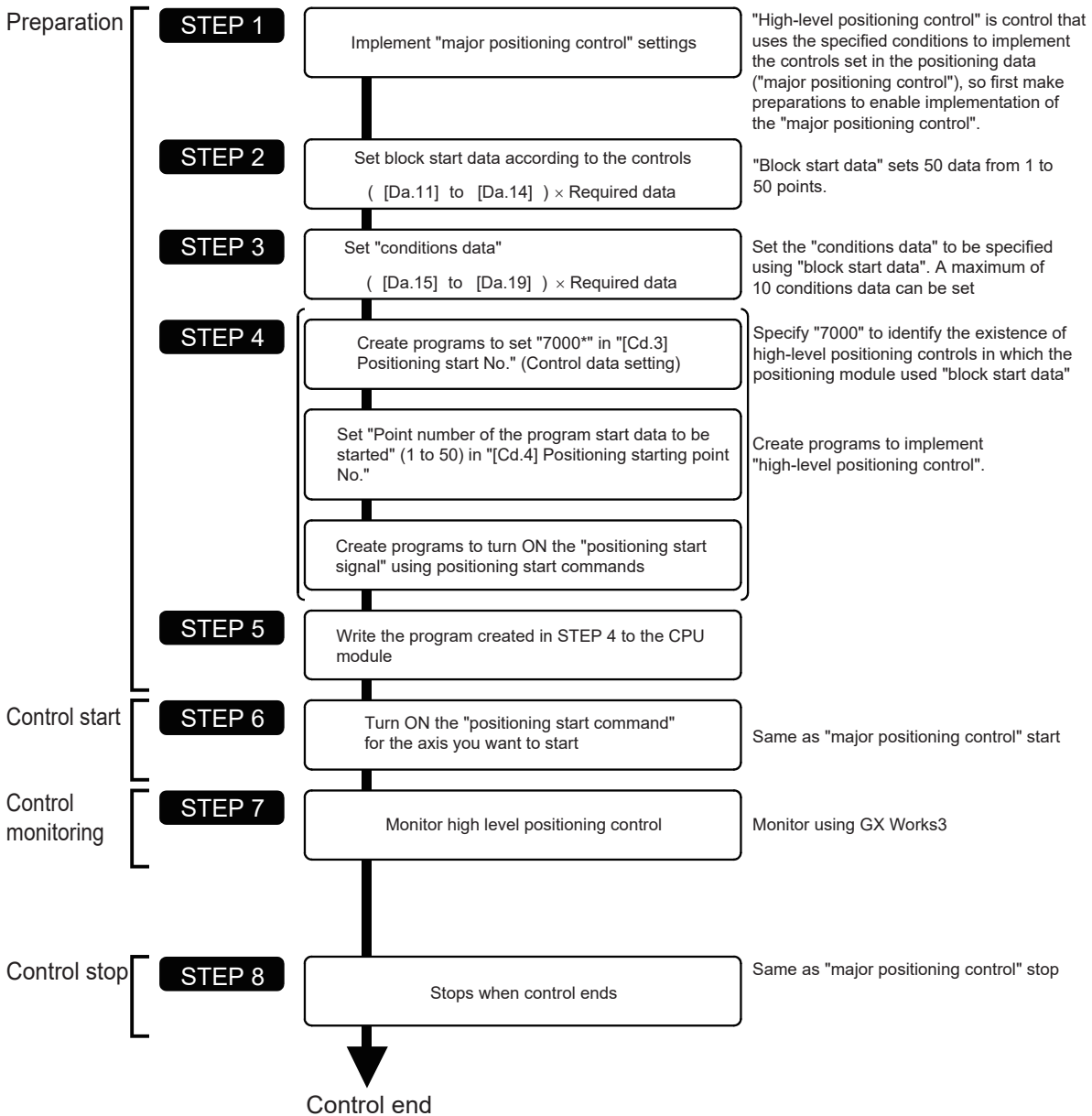

Point

- Five sets of block start data (50 points) and condition data (10 items) corresponding to No. 7000 to 7004 are set using the program.
- Five sets of data from 7000 to 7004 can also be set using GX Works3. If GX Works3 is used to set block start data and condition data corresponding to 7000 to 7004 and to write the data to the positioning module, 7000 to 7004 can be set in [Cd.3] Positioning start No. in STEP 4.

10.3 Setting the Block Start Data

Relation between various controls and block start data

Block start data must be set to perform Advanced positioning control.

The setting requirements and details of each block start data item to be set differ according to the setting of [Da.13] Special start instruction.

The following table shows the setting items of Block start data prepared for various control systems. Further, for the "Conditions Data" to implement the control implementation judgments, refer to  Page 187 Setting the Condition Data. (This section presumes the "block start data" will be set using GX Works3.)

◎: Set either of the two setting items.

×: Setting not possible

—: Setting not required (The set value is ignored. Set the value within the setting range, such as the initial value.)

Block start data setting items			Advanced positioning control			
			Block start (normal start)	Condition start	Wait start	Simultaneous start
[Da.11]	Shape	0: END	◎	◎	◎	◎
		1: Continue	◎	◎	◎	◎
[Da.12]	Start data No.	1 to 600				
[Da.13]	Special start instruction	0	1	2	3	
[Da.14]	Parameter	—	Condition data No.			

Block start data setting items			Advanced positioning control		
			Repeated start (FOR loop)	Repeated start (FOR condition)	NEXT start ^{*1}
[Da.11]	Shape	0: END	× ^{*2}	× ^{*2}	◎
		1: Continue	◎	◎	◎
[Da.12]	Start data No.	1 to 600			
[Da.13]	Special start instruction	4	5	6	
[Da.14]	Parameter	Number of repetitions	Condition data No.	—	

*1 NEXT start instruction is used in combination with Repeated start (FOR loop) and Repeated start (FOR condition). The control using only NEXT start instruction will not be performed.

*2 If End is set for the repeated start, the operation that is the same as the one of the block start (normal start) will be implemented.

Point

Setting "Block start data" using GX Works3 as much as possible is recommended. To implement the setting using programs, many programs and devices are required. The execution becomes complicated, and the scan times will increase.

Block start (normal start)

In Block start (normal start), the positioning data groups of a block are continuously implemented in a set sequence starting from the positioning data set in [Da.12] Start data No. by one start.

The following shows setting examples and a control example in which Block start data and Positioning data are set as shown in the setting examples.

Setting example

■Block start data settings

Axis 1 block start data	[Da.11] Shape	[Da.12] Start data No.	[Da.13] Special start instruction	[Da.14] Parameter
1st point	1: Continue	1	0: Block start	—
2nd point	1: Continue	2	0: Block start	—
3rd point	1: Continue	5	0: Block start	—
4th point	1: Continue	10	0: Block start	—
5th point	0: END	15	0: Block start	—
⋮				

■Positioning data settings

Axis 1 positioning data No.	[Da.1] Operation pattern	Compatible block start data	
1	00: Positioning complete	1st point	Start positioning data No. 1
2	11: Continuous path control	2nd point	Start positioning data No. 2 to 4 as block* ¹
3	01: Continuous positioning control	—	
4	00: Positioning complete	—	
5	11: Continuous path control	3rd point	Start positioning data No. 5 and 6 as block* ¹
6	00: Positioning complete	—	
⋮			
10	00: Positioning complete	4th point	Start positioning data No. 10
⋮			
15	00: Positioning complete	5th point	Start positioning data No. 11
⋮			

*1 1 block is defined as all the data continuing from the positioning data in which Continuous positioning control or Continuous path control is set in [Da.1] Operation pattern to the positioning data in which Independent positioning control (Positioning complete) is set.

Control example

The following describes the control to be executed when the operation using the 1st point block start data of the axis 1 is started.

- The positioning data is implemented in the following order and the operation stopped: Axis 1 positioning data No.1→2→3→4→5→6→10→15.

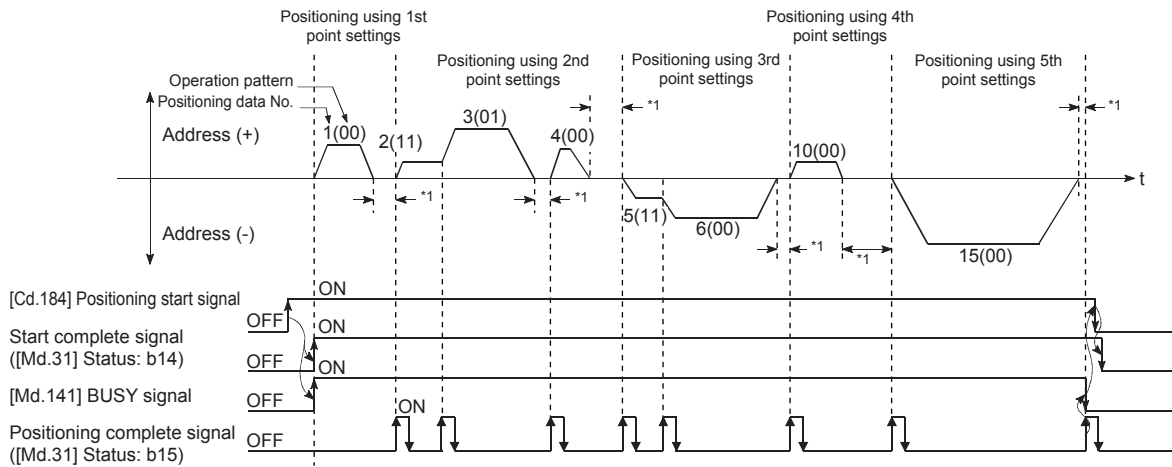

*1 Relevant positioning data dwell time

Condition start

In Condition start, the condition judgment of the condition data specified in [Da.14] Parameter is implemented for the positioning data set in [Da.12] Start data No. If the conditions have been established, the block start data set as 1: Condition start is implemented, and if the conditions have not been established, that block start data is ignored, and the block start data of the next point will be executed.

The following shows setting examples and a control example in which Block start data and Positioning data are set as shown in the setting examples.

Setting example

■Block start data settings

Axis 1 block start data	[Da.11] Shape	[Da.12] Start data No.	[Da.13] Special start instruction	[Da.14] Parameter
1st point	1: Continue	1	1: Condition start	1
2nd point	1: Continue	10	1: Condition start	2
3rd point	0: END	50	0: Block start	—
⋮				

Condition data No. has been set in [Da.14] Parameter.

■Positioning data settings

Axis 1 positioning data No.	[Da.1] Operation pattern	Compatible block start data	
1	01: Continuous positioning control	1st point	When the conditions are established, positioning data No. 1 to 3 are started en block
2	01: Continuous positioning control	—	
3	00: Positioning complete	—	
⋮			
10	11: Continuous path control	2nd point	When the conditions are established, positioning data No. 10 to 12 are started en block
11	11: Continuous path control	—	
12	00: Positioning complete	—	
⋮			
50	00: Positioning complete	3rd point	Start positioning data No. 50
⋮			

Control example

The following describes the control to be executed when the operation using the 1st point block start data of the axis 1 is started.

	Condition judgment target	Control details
(1)	The condition judgment set in Condition data No.1 is performed before the execution of the positioning data No.1 of the axis 1.	<ul style="list-style-type: none"> Positioning data No. 1, 2, and 3 are implemented and processing proceeds to (2). Conditions not established: Processing proceeds to (2).
(2)	The condition judgment set in Condition data No.2 is performed before the execution of the positioning data No.10 of the axis 1.	<ul style="list-style-type: none"> Positioning data No. 10, 11, and 12 are implemented and processing proceeds to (3). Conditions not established: Processing proceeds to (3).
(3)	—	The positioning data No.50 of Axis 1 is executed and processing stops.

Wait start

In Wait start, the condition judgment of the condition data specified in [Da.14] Parameter is implemented for the positioning data set in [Da.12] Start data No. If the conditions have been established, the block start data is implemented, and if the conditions have not been established, the control stops (waits) until the conditions are established.

The following shows setting examples and a control example in which Block start data and Positioning data are set as shown in the setting examples.

Setting example

■Block start data settings

Axis 1 block start data	[Da.11] Shape	[Da.12] Start data No.	[Da.13] Special start instruction	[Da.14] Parameter
1st point	1: Continue	1	2: Wait start	3
2nd point	1: Continue	10	0: Block start	—
3rd point	0: END	50	0: Block start	—
⋮				

Condition data No. has been set in [Da.14] Parameter.

■Positioning data settings

Axis 1 positioning data No.	[Da.1] Operation pattern	Compatible block start data	
1	01: Continuous positioning control	1st point	When the conditions are established, positioning data No. 1 to 3 are started en block
2	01: Continuous positioning control	—	
3	00: Positioning complete	—	
⋮			
10	11: Continuous path control	2nd point	Positioning data No. 10 to 12 are started en block
11	11: Continuous path control	—	
12	00: Positioning complete	—	
⋮			
50	00: Positioning complete	3rd point	Start positioning data No. 50
⋮			

Control example

The following describes the control to be executed when the operation using the 1st point block start data of the axis 1 is started.

	Condition judgment target	Control details
(1)	The condition judgment set in Condition data No.3 is performed to Positioning data No.1 of Axis 1.	<ul style="list-style-type: none"> Positioning data No. 1, 2, and 3 are implemented and processing proceeds to (2). Conditions not established: Control stops (waits) until the conditions are established, and then proceeds to → (1)
(2)	—	The positioning data No.10, 11, 12, and 50 of Axis 1 are executed and processing stops.

Simultaneous start

In Simultaneous start, the positioning data set in [Da.12] Start data No. and positioning data of other axes set in the condition data are simultaneously implemented. (Pulses are output at the same timing.) (Specify Condition data with [Da.14] Parameter.)

The following shows setting examples and a control example in which Block start data and Positioning data are set as shown in the setting examples.

Setting example

■Block start data settings

Axis 1 block start data	[Da.11] Shape	[Da.12] Start data No.	[Da.13] Special start instruction	[Da.14] Parameter
1st point	0: END	1	3: Simultaneous start	4
:				

The positioning data of the axis 2 for performing the simultaneous start is assumed to be set for the condition data specified with [Da.14] Parameter.

■Positioning data settings

Axis 1 positioning data No.	[Da.1] Operation pattern	Compatible block start data	
1	01: Continuous positioning control	1st point	During simultaneous start, positioning data No. 1 to 3 are started en block
2	01: Continuous positioning control	—	
3	00: Positioning complete	—	
:			

Control example

The following describes the control to be executed when the operation using the 1st point block start data of the axis 1 is started.

	Condition judgment target	Control details
(1)	The axis operation status of the axis 2 which is regarded as the simultaneous starting axis.	<ul style="list-style-type: none"> Axis 2 is in the standby state. : Go to (2) Axis 2 is positioning. : An error occurs and no simultaneous start will be implemented.
(2)	—	The positioning data No.1 of Axis 1 and the positioning data of the axis 2 set to Condition data No.4 are simultaneously started.

Precautions

The positioning data numbers implemented by the simultaneous starting axis is set for the conditions data ([Da.18] Parameter 1 and [Da.19] Parameter 2). Set 0 for the starting axis. (Axis that implemented the positioning start.) If a value other than 0 is set, the positioning data No. set in [Da.18] Parameter 1 or [Da.19] Parameter 2 is given priority to be implemented rather than [Da.12] Start data No.

For details, refer to the following.

📖 Page 438 Condition Data

Repeated start (FOR loop)

In Repeated start (FOR loop), the data between the block start data in which 4: FOR loop is set in [Da.13] Special start instruction and the block start data in which 6: NEXT start is set in [Da.13] Special start instruction is repeatedly implemented for the number of times set in [Da.14] Parameter. An endless loop will result if the number of repetitions is 0.

(The number of repetitions is set in [Da.14] Parameter of the block start data in which 4: FOR loop is set in [Da.13] Special start instruction.)

The following shows setting examples and a control example in which Block start data and Positioning data are set as shown in the setting examples.

Setting example

■Block start data settings

Axis 1 block start data	[Da.11] Shape	[Da.12] Start data No.	[Da.13] Special start instruction	[Da.14] Parameter
1st point	1: Continue	1	4: FOR loop	2
2nd point	1: Continue	10	0: Block start	—
3rd point	0: END	50	6: NEXT start	—
⋮				

No. of repetitions has been set in [Da.14] Parameter.

■Positioning data settings

Axis 1 positioning data No.	[Da.1] Operation pattern	Compatible block start data	
1	01: Continuous positioning control	1st point	Start positioning data No. 1 to 3 en block (Repeat start twice from 1st to 3rd point)
2	01: Continuous positioning control	—	
3	00: Positioning complete	—	
⋮			
10	11: Continuous path control	2nd point	Positioning data No. 10 and 11 are started en block
11	00: Positioning complete	—	
⋮			
50	01: Continuous positioning control	3rd point	Positioning data No. 50 and 51 are started en block
51	00: Positioning complete	—	
⋮			

Control example

The following describes the control to be executed when the operation using the 1st point block start data of the axis 1 is started.

- The positioning data No.1, 2, 3, 10, 11, 50, and 51 of the axis 1 are executed.
- Processing returns to the 1st point block start data of the axis 1 and the positioning data No.1, 2, 3, 10, 11, 50, and 51 is executed again, then the control is stopped. (Processing will be repeated for the number of times (2 times) set in [Da.14].)

Repeated start (FOR condition)

In Repeated start (FOR condition), the data between the block start data in which 5: FOR condition is set in [Da.13] Special start instruction and the block start data in which 6: NEXT start is set in [Da.13] Special start instruction is repeatedly implemented until the conditions set in the condition data are established.

The condition judgment is implemented when switching to the point of 6: NEXT start (Before the positioning at the NEXT start point) is implemented. (Specify the condition data in [Da.14] Parameter of the block start data in which 5: FOR condition is set in [Da.13] Special start instruction.)

The following shows setting examples and a control example in which Block start data and Positioning data are set as shown in the setting examples.

Setting example

■Block start data settings

Axis 1 block start data	[Da.11] Shape	[Da.12] Start data No.	[Da.13] Special start instruction	[Da.14] Parameter
1st point	1: Continue	1	5: FOR condition	5
2nd point	1: Continue	10	0: Block start	—
3rd point	0: END	50	6: NEXT start	—
⋮				

Condition data No. has been set in [Da.14] Parameter.

■Positioning data settings

Axis 1 positioning data No.	[Da.1] Operation pattern	Compatible block start data	
1	01: Continuous positioning control	1st point	Positioning data No. 1 to 3 are started en block
2	01: Continuous positioning control	—	
3	00: Positioning complete	—	
⋮			
10	11: Continuous path control	2nd point	Positioning data No. 10 and 11 are started en block
11	00: Positioning complete	—	
⋮			
50	01: Continuous positioning control	3rd point	Start positioning data No. 50 and 51 en block (If the conditions are not established, repeat start from 1st to 3rd point)
51	00: Positioning complete	—	
⋮			



Control example

The following describes the control to be executed when the operation using the 1st point block start data of the axis 1 is started.

	Condition judgment target	Control details
(1)	—	The positioning data No.1, 2, 3, 10, and 11 of the axis 1 are executed.
(2)	The condition judgment set in the condition data No.5 of the axis 1 is performed.*1	<ul style="list-style-type: none"> • Conditions not established: Implement "Positioning data No. 50 and 51", and go to (1). • Conditions established: Implement "Positioning data No. 50 and 51", and stop positioning.

*1 Conditions are judged when switching to the NEXT start point (3rd point in the settings example) (before positioning of the NEXT start point is implemented).

Restrictions when the NEXT start is used

NEXT start instruction shows the end of the repetition when the repeated start (FOR loop) and repeated start (FOR condition) are implemented. ( Page 184 Repeated start (FOR loop),  Page 185 Repeated start (FOR condition))

This section describes the restrictions when 6: NEXT start is set in Block start data.

- The processing when 6: NEXT start is implemented before the implementation of 4: FOR loop or 5: FOR condition is the same as that for 0: Block start.
- The repeated processing will not be implemented if 6: NEXT start is not set after 4: FOR loop or 5: FOR condition. (However, no error will occur.)
- Nesting is not possible between 4: FOR loop and 6: NEXT start, or between 5: FOR condition and 6: NEXT start. If nesting is attempted, FOR to NEXT nest construction (Warning code: 09F1H) occurs. The destination of jump by NEXT at the 7th point is changed to the 4th point and NEXT at the 9th point is processed as Normal start.

When a nest construction is not configured		When a nest construction is configured	
Block Start Data	[Da.13] Special start instruction	Block Start Data	[Da.13] Special start instruction
1st point	Normal start	1st point	Normal start
2nd point	FOR ←	2nd point	FOR
3rd point	Normal start	3rd point	Normal start
4th point	NEXT	4th point	FOR ←
5th point	Normal start	5th point	Normal start
6th point	Normal start	6th point	Normal start
7th point	FOR ←	7th point	NEXT
8th point	Normal start	8th point	Normal start
9th point	NEXT	9th point	NEXT
.		.	
.		.	
—		<ul style="list-style-type: none"> • A warning occurs when FOR at the 4th point is executed. • The destination of jump by NEXT at the 7th point is changed to the 4th point and NEXT at the 9th point is processed as Normal start. 	

10.4 Setting the Condition Data

Relation between various controls and condition data

Set Condition data in the following cases.

- When conditions are set during the implementation of the JUMP instruction (Major positioning control)
- When conditions are set during the implementation of advanced positioning control

Condition data includes the five setting items from [Da.15] to [Da.19], but the setting requirements and details of each setting item depend on the control system and setting conditions used.

The following table lists the condition data [Da.15] Condition target corresponding to each type of the controls. (This section presumes the "conditions data" will be set using GX Works3.)

- ⊙: Set either of the two setting items.
- ×: Setting not possible

Setting items for [Da.15] Condition target	Advanced positioning control				Major positioning control
	Condition start	Wait start	Simultaneous start	Repeated start (FOR condition)	JUMP instruction
01H: Monitor data ([Md.31] b12 to b15, [Md.140], [Md.141]) ^{*1}	⊙	⊙	×	⊙	⊙
02H: Control data ([Cd.180] to [Cd.184], [Cd.190]) ^{*1}	⊙	⊙	×	⊙	⊙
03H: Buffer memory (1 word) ^{*1}	⊙	⊙	×	⊙	⊙
04H: Buffer memory (2 words) ^{*1}	⊙	⊙	×	⊙	⊙
05H: Positioning data No.	×	×	⊙	×	×

*1 Intended for monitor data, control data, and buffer memory with their own positioning modules.

Restriction 

Setting "Conditions data" using GX Works3 as much as possible is recommended. To implement the settings using programs, many programs and devices are required. The execution becomes complicated, and the scan times will increase.

The setting requirements and details of the setting items of the condition data [Da.16] to [Da.19] depend on the settings in [Da.15] Condition target.

The following table lists the setting items of [Da.16] to [Da.19] corresponding to [Da.15] Condition target.

—: Setting not required (The set value is ignored. Set the value within the setting range, such as the initial value.)

** : Value stored in the buffer memory address specified in [Da.17]

[Da.15] Condition target	[Da.16] Condition operator	[Da.17] Address	[Da.18] Parameter 1	[Da.19] Parameter 2
01H: Monitor data ([Md.31] b12 to b15, [Md.140], [Md.141])	07H: SIG=ON 08H: SIG=OFF	—	00H: READY 01H: Module access flag 04H: M code ON (Axis 1) 05H: M code ON (Axis 2) 08H: Error detection (Axis 1) 09H: Error detection (Axis 2) 0CH: BUSY (Axis 1) 0DH: BUSY (Axis 2) 10H: Start complete (Axis 1) 11H: Start complete (Axis 2) 14H: Positioning complete (Axis 1) 15H: Positioning complete (Axis 2)	—
02H: Control data ([Cd.180] to [Cd.184], [Cd.190])			00H: PLC READY 04H: Axis stop (Axis 1) 05H: Axis stop (Axis 2) 08H: Forward JOG (Axis 1) 09H: Reverse JOG (Axis 1) 0AH: Forward JOG (Axis 2) 0BH: Reverse JOG (Axis 2) 10H: Positioning start (Axis 1) 11H: Positioning start (Axis 2) 14H: Implementation prohibition flag (Axis 1) 15H: Implementation prohibition flag (Axis 2)	
03H: Buffer memory (1 word) ^{*2}	01H: **=P1 02H: **≠P1	Buffer memory address	P1 (Numerical value)	P2 (Numerical value) (Set this value only when [Da.16] is "05H" or "06H".)
04H: Buffer memory (2 words) ^{*2}	03H: **≤P1 04H: **>P1 05H: P1≤**≤P2 06H: **≤P1, P2≤**			
05H: Positioning data No.	10H: Axis 1 specification 20H: Axis 2 specification	—	Lower 16 bits	Axis 1 positioning data No. ^{*3}
			Upper 16 bits	Axis 2 positioning data No. ^{*3}

*2 ≤ and ≥ are judged with signed values. (Page 439 [Da.16] Condition operator)

*3 Set 0 for the starting axis. (Axis that implemented the positioning start.) If a value other than 0 is set, the positioning data set in [Da.18] Parameter 1 or [Da.19] Parameter 2 is implemented rather than [Da.12] Start data No.

Judgment whether the condition operator is "=" or "≠" at the wait start

Judgment on data is implemented for each control cycle of the positioning module. Consequently, in the judgment on the data such as the current feed value which varies continuously, the condition operator "=" may not be detected. In cases like this, use a range operator.



PLC CPU memo area can be specified as the buffer memory address to be specified in [Da.17].

Setting examples of the condition data

The following shows setting examples of Condition data.

Example 1

This example uses the on/off state of a device as a condition.

- [Condition] If "[Md.141] BUSY: b0" (=Axis 1 BUSY signal) is "OFF"

[Da.15] Condition target	[Da.16] Condition operator	[Da.17] Address	[Da.18] Parameter 1	[Da.19] Parameter 2
01H: Monitor data ([Md.31] b12 to b15, [Md.140], [Md.141])	08H: SIG=OFF	—	0CH: BUSY (Axis 1)	—

Example 2

This example uses a numerical value stored in the buffer memory as a condition.

- [Condition] If the value stored in buffer memory addresses: 800 and 801 ("[Md.20] Current feed value" of Axis 1) is "100" min.

[Da.15] Condition target	[Da.16] Condition operator	[Da.17] Address	[Da.18] Parameter 1	[Da.19] Parameter 2
04H: Buffer memory (2 words)	04H: **≥P1	800	1000	—

Example 3

This example specifies an axis and the positioning data No. of the axis as the target for the simultaneous start.

- [Condition] The positioning data No.3 of the axis 2 is the target for the simultaneous start.

[Da.15] Condition target	[Da.16] Condition operator	[Da.17] Address	[Da.18] Parameter 1	[Da.19] Parameter 2
05H: Positioning data No.	20H: Axis 2 specification	—	0003H in the upper 16 bits*1	—*1

*1 Set 0000H for the starting axis (Axis that implemented the positioning start).

10.5 Start Program for the Advanced Positioning Control

Starting the advanced positioning control

To execute the advanced positioning control, a program must be created to start the control in the same method as for the major positioning control.

The procedure for starting the 1st point block start data (Regarded as block No.7000) set in axis 1 is described below.

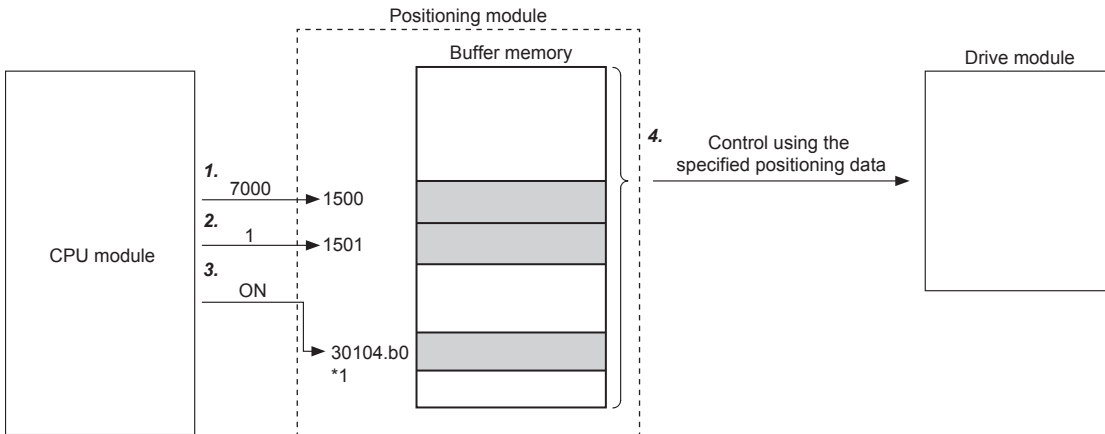

*1 If starting positioning using the next scan for which positioning has finished, use start completion signal ([Md.31]: Status: b14) as the interlock circuit in the program to enable start after the start completion signal ([Md.31] Status: b14) turns OFF after "[Cd.184] Positioning start signal" is turned OFF.

1. Set 7000 in [Cd.3] Positioning start No. (By setting this value, the control is established as advanced positioning control using the block start data.)
2. Set the point number of Block start data started. (In this case, set 1.)
3. Turn on Start signal.
4. The positioning data set to 1st point block start data is started.

Start program example for the advanced positioning control

The following shows a start program example for the advanced positioning control in which the 1st point block start data of the axis 1 is started. (The block No. is regarded as 7000.)

Control data requiring settings

The following control data must be set to execute the advanced positioning control. The setting is performed using a program.

Setting item		Setting value	Setting details	Buffer memory address	
				Axis 1	Axis 2
[Cd.3]	Positioning start No.	7000	Set 7000, which indicates the control using Block start data.	1500	1600
[Cd.4]	Positioning starting point No.	1	Set the point number of the block start data started.	1501	1601

For details on the settings, refer to the following.

☞ Page 470 [Cd.3] Positioning start No.

☞ Page 470 [Cd.4] Positioning starting point No.

Start condition

Satisfy the following conditions to start a program. In addition, set the required conditions in the program to prevent an operation from starting if the conditions are not satisfied.

Signal name		Signal status		Device
Interface signal	PLC READY signal	ON	The CPU module is ready.	[Cd.190] PLC READY signal
	READY signal	ON	Positioning module READY	[Md.140] Module status.b0
	Module access flag	ON	The positioning module buffer memory can be accessed	[Md.140] Module status.b1
	Axis stop signal	OFF	Axis stop signal is off.	[Cd.180] Axis stop signal
	Start complete signal	OFF	Start complete signal is off.	[Md.31] Status.b14
	BUSY signal	OFF	BUSY signal is off.	[Md.141] BUSY signal
	Error detection signal	OFF	No error has been detected.	[Md.31] Status.b13
	M code ON signal	OFF	M code ON signal is off.	[Md.31] Status.b12
External signal	Drive unit READY signal	ON	The drive unit is ready.	—
	Stop signal	OFF	Stop signal is off.	—
	Upper limit (FLS)	ON	The current position is within the limit.	—
	Lower limit (RLS)	ON	The current position is within the limit.	—

Start time chart

The following figure shows a time chart in a case when the positioning data No.1, 2, 10, 11, and 12 of Axis 1 are continuously implemented as an example.

Block start data settings

Axis 1 block start data	[Da.11] Shape	[Da.12] Start data No.	[Da.13] Special start instruction	[Da.14] Parameter
1st point	1: Continue	1	0: Start block	—
2nd point	0: END	10	0: Start block	—
⋮				

Positioning data settings

Axis 1 positioning data No.	[Da.1] Operation pattern	Compatible block start data	
1	11: Continuous path control	1st point	Positioning data Nos. 1 and 2 are started en block
2	00: Positioning complete	—	
⋮			
10	11: Continuous path control	2nd point	Positioning data No. 10 to 12 are started en block
11	11: Continuous path control	—	
12	00: Positioning complete	—	
⋮			

Start time chart

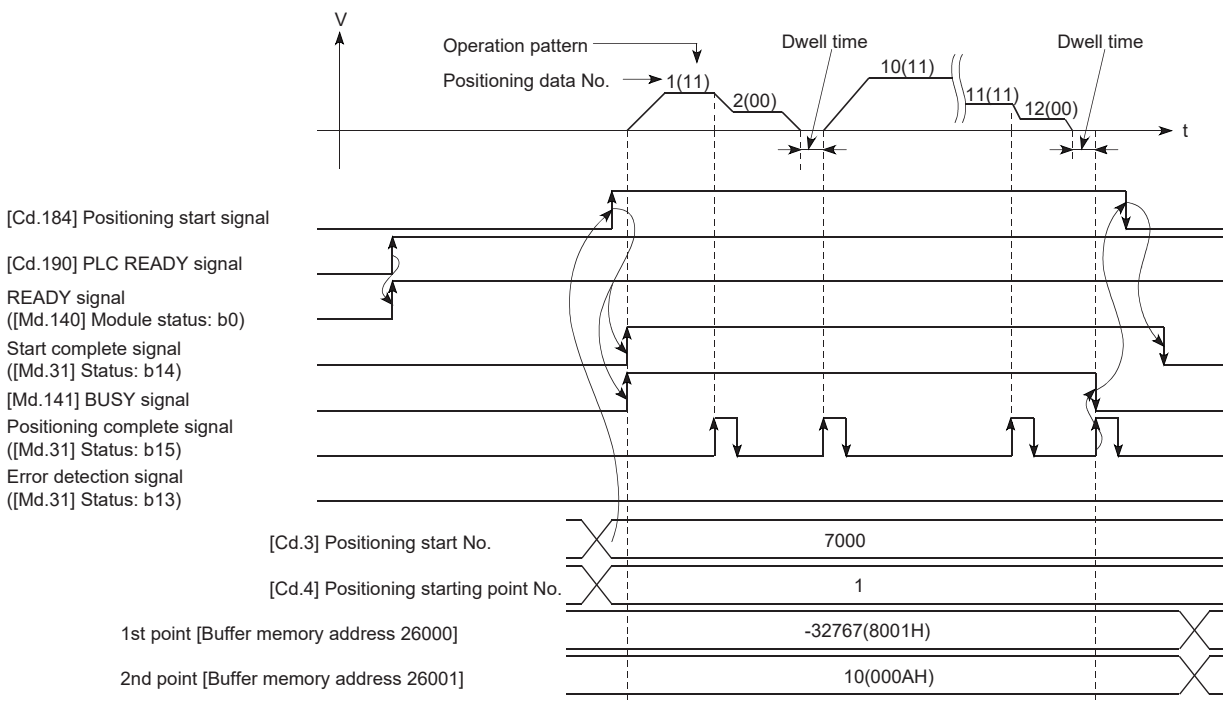

Program example

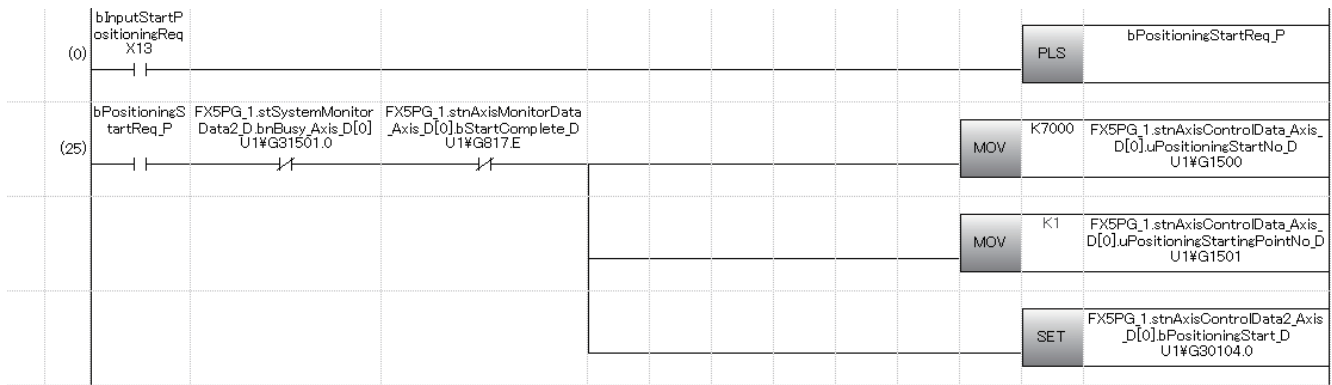

Classification	Label Name	Description												
Module label	FX5PG_1.stSystemMonitorData2_D.bnBusy_Axis_D[0]	Axis 1 BUSY signal												
	FX5PG_1.stnAxisMonitorData_Axis_D[0].bStartComplete_D	Axis 1 Start complete signal												
	FX5PG_1.stnAxisControlData2_Axis_D[0].bPositioningStart_D	Axis 1 Positioning start signal												
	FX5PG_1.stnAxisControlData_Axis_D[0].uPositioningStartNo_D	Axis 1 Positioning start No.												
	FX5PG_1.stnAxisControlData_Axis_D[0].uPositioningStartingPointNo_D	Axis 1 Positioning starting point No.												
Global label, local label	Define the global label or local label as follows. Setting Assign (Device/Label) for labels is not necessary because the unused internal relay and data device are automatically assigned to the labels.													
	<table border="1"> <thead> <tr> <th></th> <th>Label Name</th> <th>Data Type</th> <th></th> <th>Class</th> </tr> </thead> <tbody> <tr> <td>1</td> <td>bCurrentFeedValueReadReq</td> <td>Bit</td> <td>...</td> <td>VAR</td> </tr> </tbody> </table>		Label Name	Data Type		Class	1	bCurrentFeedValueReadReq	Bit	...	VAR			
	Label Name	Data Type		Class										
1	bCurrentFeedValueReadReq	Bit	...	VAR										
	<table border="1"> <thead> <tr> <th></th> <th>Label Name</th> <th>Data Type</th> <th></th> <th>Class</th> <th>Assign (Device/Label)</th> </tr> </thead> <tbody> <tr> <td>12</td> <td>bInputStartPositioningReq</td> <td>Bit</td> <td>...</td> <td>VAR_GLOBAL</td> <td>X13</td> </tr> </tbody> </table>		Label Name	Data Type		Class	Assign (Device/Label)	12	bInputStartPositioningReq	Bit	...	VAR_GLOBAL	X13	
	Label Name	Data Type		Class	Assign (Device/Label)									
12	bInputStartPositioningReq	Bit	...	VAR_GLOBAL	X13									

11 MANUAL CONTROL

This chapter describes the details and usage of the manual control.

Manual control includes a manual pulse generator operation to generate pulse output commands that are issued during the JOG and inching operations which are executed by turning on JOG start signal, or from the manual pulse generator.

The chapter describes manual control used via a program loaded in the CPU module.

11.1 Overview of the Manual Control

Three manual control methods

When the manual control is used, the positioning operation is performed in response to a signal input from an external source. Positioning data is not used.

Manual control is classified into three controls: JOG operation, inching operation, and manual pulse generator operation.

JOG operation

In the JOG operation, the machine is moved only for a movement amount (pulses are continuously output while JOG start signal is on). This control method is used to move the workpiece in the direction corresponding to the limit signal if turned on when operation has stopped due to the limit signal turning off to check the positioning system connection and obtain the positioning data address ( Page 291 Teaching function).

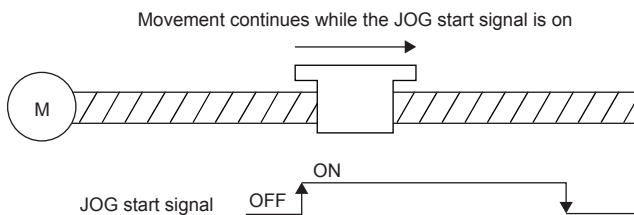

Inching operation

In the inching operation, pulses for a minute movement amount are output manually at 1.77 ms. By setting Inching movement amount of the axis control data in the JOG operation, the workpiece moves only for the set movement amount. (However, the JOG operation is performed when Inching movement amount is set to 0.)

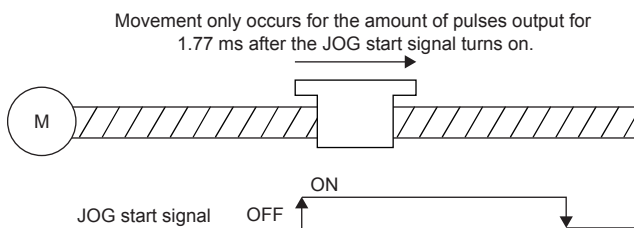

Manual pulse generator operation

Manual pulse generator operation performs positioning in accordance with the number of pulses input from the manual pulse generator, which is to say that it outputs the same number of pulses that were input. This method is used to manually make fine adjustments for precise positioning and to obtain positioning addresses.

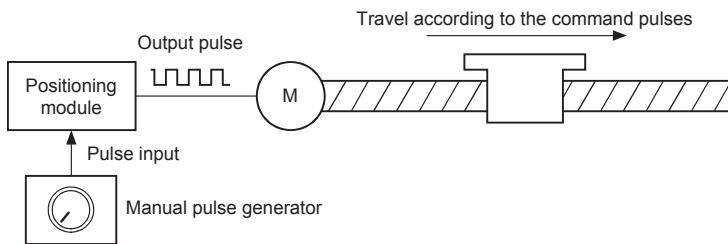

■Sub functions for the manual control

For details on the sub functions that can be combined with the manual control, refer to the following.

☞ Page 34 Combining Main and Sub Functions

Refer to the following for more information on each sub function.

☞ Page 218 CONTROL SUB FUNCTION

■Manual control using GX Works3

GX Works3 test mode can be used to perform JOG operations and Inching operation as well as enable/disable manual pulse generator operation.

■Monitoring manual control

The positioning monitor in GX Works3 can be used to monitor manual control operation. Refer to the following for more information on the positioning monitor.

☞ Page 339 Positioning Monitor

11.2 JOG Operation

Overview of the JOG operation



Use the hardware stroke limit function when performing the JOG operation at a position close to the upper or lower limit. (☞ Page 248 Hardware stroke limit function)

If the hardware stroke limit function is not used, the workpiece may be moved beyond the movement range resulting in an accident.

Operation

JOG operation moves a workpiece in the specified direction by turning on the [Cd.181] Forward JOG start signal or the [Cd.182] Reverse JOG start signal is turned on to output pulses from positioning module to the drive unit. The following figure illustrates an example of JOG operation.

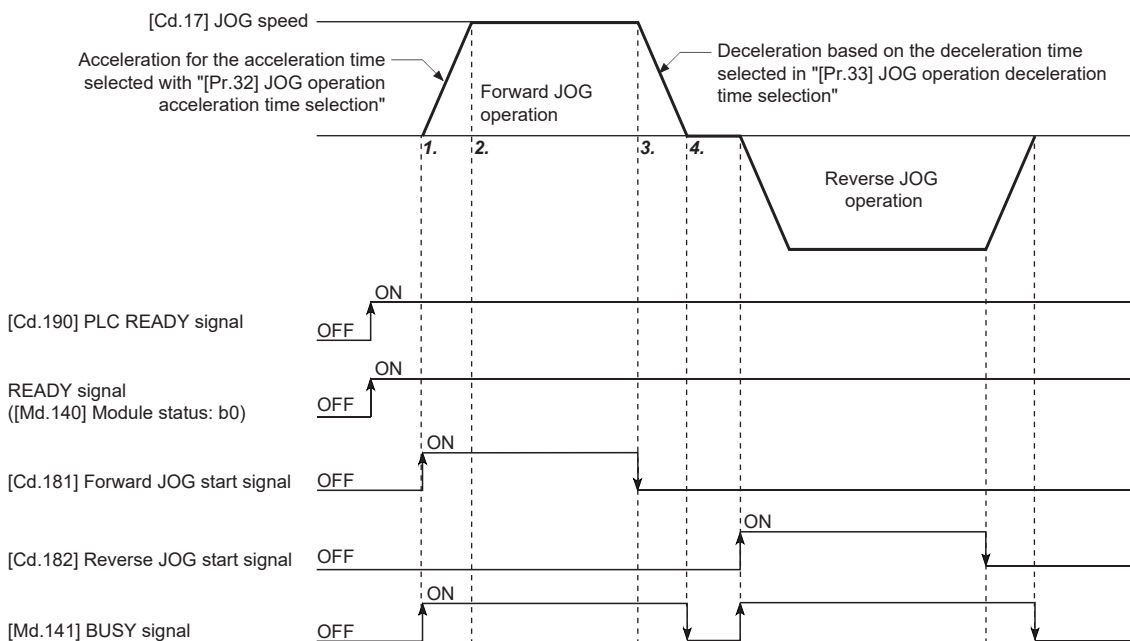

1. When a start signal is turned on, acceleration starts and continues in the direction specified by the start signal for the acceleration time specified with [Pr.32] JOG operation acceleration time selection. BUSY signal turns on at this time.
2. The accelerating workpiece continues moving at the speed set with [Cd.17] JOG speed once it is reached. (The workpiece moves at a constant speed between operation steps 2 and 3.)
3. When the start signal is turned off, deceleration starts and continues in the direction specified by the "[Cd.17] JOG speed" for the deceleration time specified with [Pr.33] JOG operation deceleration time selection.
4. Operation stops when the speed reaches 0. BUSY signal turns off at this time.

Precautions during the operation

- For safety reasons, set [Cd.17] JOG speed to a slow speed and then gradually increase the speed while checking operation.
- If the set JOG speed is out of the setting range or 0 when the JOG operation is started, Outside JOG speed range (Error code: 1980H) occurs and the operation will not start.
- If the value set in [Pr.31] JOG speed limit value is larger than the value in [Pr.8] Speed limit value, JOG speed limit value error (Error code: 1AB8H) occurs and the operation will not start.
- If the value set in [Cd.17] JOG speed exceeds the speed set in [Pr.31] JOG speed limit value, the workpiece will move at the value set in [Pr.31] JOG speed limit value, and JOG speed limit value (Warning code: 0991H) will occur in the positioning module.
- The JOG operation continues even when a warning has occurred.
- Set 0 for [Cd.16] Inching movement amount. If a value other than 0 is set, the inching operation is performed. (Page 204 Inching Operation)

Operation when a stroke limit error occurs

When the operation stops due to a hardware stroke limit error or software stroke limit error during the operation, the JOG operation can be performed in the opposite direction (direction toward the normal range) after the error is reset. (If JOG start signal is turned on in the direction toward outside the limit range, the error occurs again.)

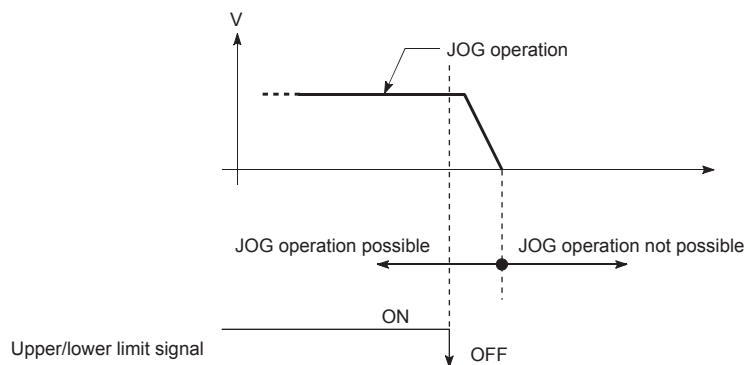

Operation timing and the processing time

The following shows the details on the operation timing and processing time in the JOG operation.

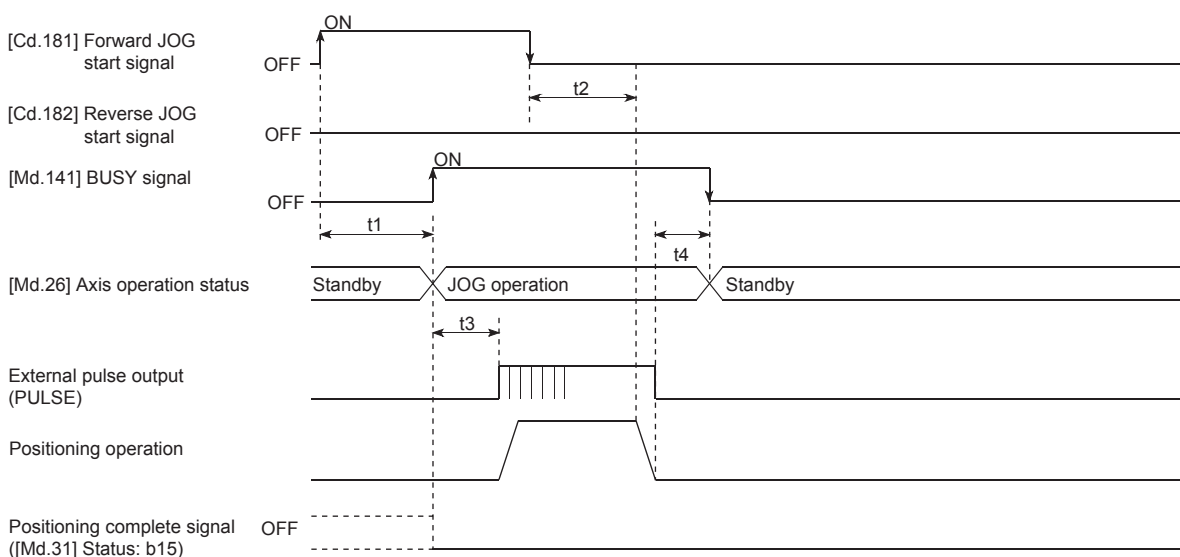

Normal timing time

t1	t2	t3	t4
1.0 to 3.0 ms	1.3 to 2.2 ms	1.3 to 2.2 ms	1.3 to 2.2 ms

Operation procedure of the JOG operation

The JOG operation is performed in the following procedure.

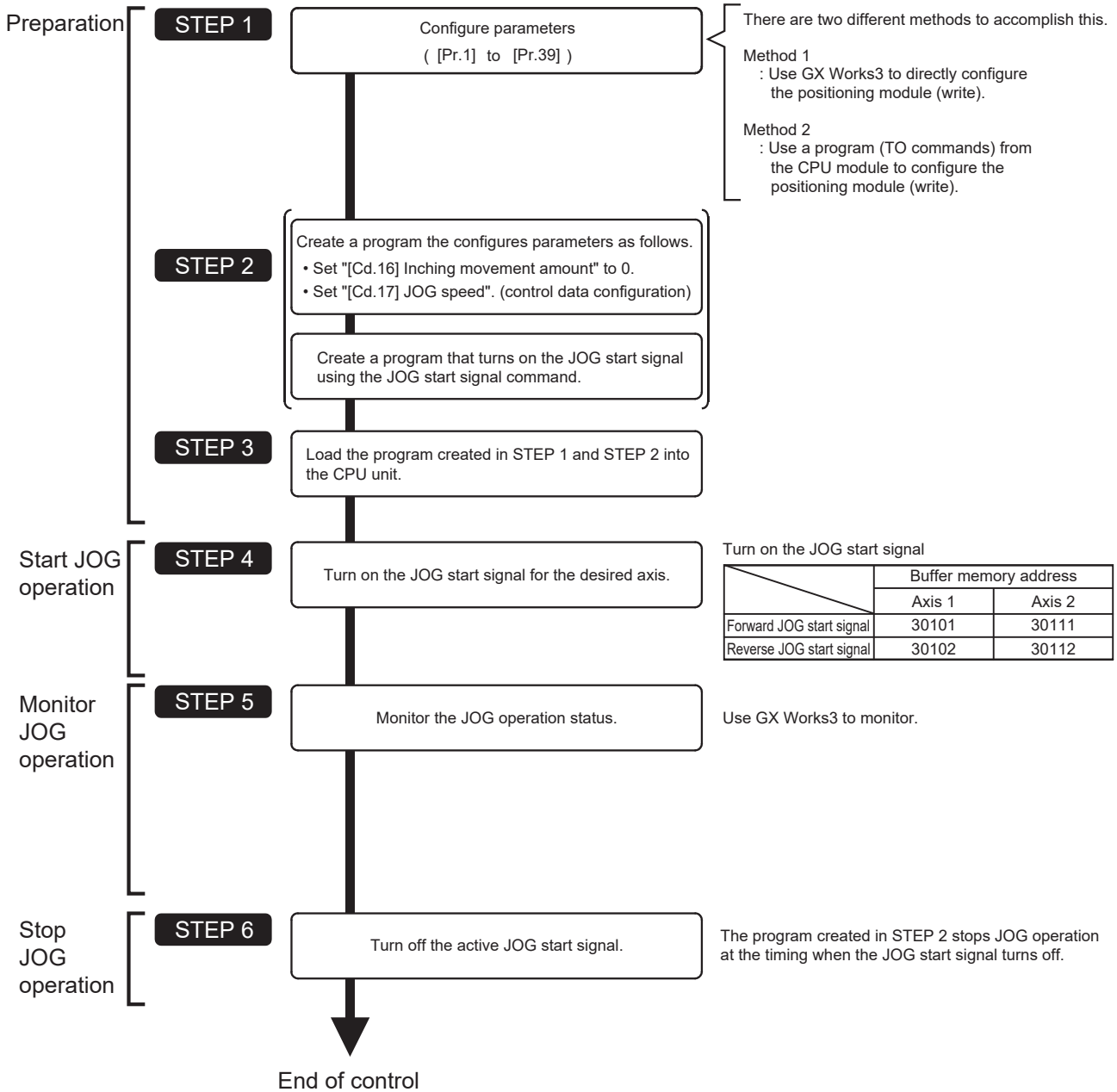

Point

- Mechanical elements such as limit switches are considered as already installed.
- Setting parameters is the common operation for all controls using the positioning module.

Parameters required for the JOG operation

To perform the JOG operation, parameters must be set. The following table shows the required parameters for performing the JOG operation. When only the JOG operation is performed, parameters not described below are not required. (Set the value within the setting range, such as the initial value.)

◎: Always set

○: Set as required (set a value within the setting range such as the initial value when the item is not used.)

Setting item			Setting requirement
Parameter	[Pr.1]	Unit setting	◎
	[Pr.2]	No. of pulses per rotation (Ap) (Unit: pulse)	◎
	[Pr.3]	Movement amount per rotation (Al) (Unit: pulse)	◎
	[Pr.4]	Unit magnification (Am)	◎
	[Pr.5]	Pulse output mode	◎
	[Pr.6]	Rotation direction setting	◎
	[Pr.7]	Bias speed at start (Unit: pulse/s)	○
	[Pr.8]	Speed limit value (Unit: pulse/s)	◎
	[Pr.9]	Acceleration time 0 (Unit: ms)	◎
	[Pr.10]	Deceleration time 0 (Unit: ms)	◎
	[Pr.11]	Backlash compensation amount (Unit: pulse)	○
	[Pr.12]	Software stroke limit upper limit value (Unit: pulse)	○
	[Pr.13]	Software stroke limit lower limit value (Unit: pulse)	○
	[Pr.14]	Software stroke limit selection	○
	[Pr.15]	Software stroke limit valid/invalid setting	○
	[Pr.17]	Torque limit setting value (Unit: %)	○
	[Pr.23]	Output signal logic selection	○
	[Pr.25]	Acceleration time 1 (Unit: ms)	○
	[Pr.26]	Acceleration time 2 (Unit: ms)	○
	[Pr.27]	Acceleration time 3 (Unit: ms)	○
	[Pr.28]	Deceleration time 1 (Unit: ms)	○
	[Pr.29]	Deceleration time 2 (Unit: ms)	○
	[Pr.30]	Deceleration time 3 (Unit: ms)	○
	[Pr.31]	JOG speed limit value (Unit: pulse/s)	◎
	[Pr.32]	JOG operation acceleration time selection	◎
	[Pr.33]	JOG operation deceleration time selection	◎
	[Pr.34]	Acceleration/deceleration processing selection	○
	[Pr.35]	S-curve ratio (Unit: %)	○
	[Pr.36]	Sudden stop deceleration time (Unit: ms)	○
	[Pr.37]	Stop group 1 sudden stop selection	○
	[Pr.38]	Stop group 2 sudden stop selection	○
	[Pr.39]	Stop group 3 sudden stop selection	○

For details on the settings, refer to the following.

 Page 354 DATA USED FOR POSITIONING CONTROL

Point 

- Setting parameters is the common operation for all controls using the positioning module. When performing another control (Major positioning control, Advanced positioning control, or OPR control), configure the setting items required for the control.
- Parameters are set for each axis.

Creating a start program for the JOG operation

To perform the JOG operation, create a program. When creating a program, consider Control data requiring settings, Start condition, and Start time chart. The following shows an example when the JOG operation is started for the axis 1. ([Cd.17] JOG speed is set to 100.00 mm/min.)

Control data requiring settings

The following control data must be set to execute the JOG operation. The setting is executed with a program.

Setting item		Setting value	Setting detail	Buffer memory address	
				Axis 1	Axis 2
[Cd.16]	Inching movement amount	0	Set to "0" for JOG operation.	1517	1617
[Cd.17]	JOG speed	10000	Set a value that is equal to or larger than the value in [Pr.7] Bias speed at start and also equal to or smaller than the one in [Pr.31] JOG speed limit value.	1518 1519	1618 1619

For details on the settings, refer to the following.

☞ Page 474 [Cd.16] Inching movement amount

☞ Page 474 [Cd.17] JOG speed

Start condition

Satisfy the following conditions to start a program. In addition, set the required conditions in the program to prevent an operation from starting if the conditions are not satisfied.

Signal name		Signal status		Device
I/O signals	PLC READY signal	ON	The CPU module is ready.	[Cd.190] PLC READY signal
	READY signal	ON	Positioning module READY.	[Md.140] Module status.b0
	Module access flag ^{*1}	ON	Positioning module buffer memory access allowed.	[Md.140] Module status.b1
	Axis stop signal	OFF	Axis stop signal is off.	[Cd.180] Axis stop signal
	Start complete signal	OFF	Start complete signal is off.	[Md.31] Status.b14
	BUSY signal	OFF	Positioning module inactive.	[Md.141] BUSY signal
	Error detection signal	OFF	No error has been detected.	[Md.31] Status.b13
	M code ON signal	OFF	M code ON signal is off.	[Md.31] Status.b12
External signal	Drive unit READY signal	ON	The drive unit is ready.	—
	Stop signal	OFF	Stop signal is off.	—
	Upper limit (FLS)	ON	The current position is within the limit.	—
	Lower limit (RLS)	ON	The current position is within the limit.	—

*1 To access the buffer memory, the interlock must be provided so that the buffer memory can be accessed after Module access flag ([Md.140] Module status: b1) turns on. When no interlock is provided, the buffer memory may be accessed while the module parameter and module extension parameter that are sent from the CPU module are updated. If the buffer memory is accessed during the update, an unexpected value may be read or written.

Start time chart

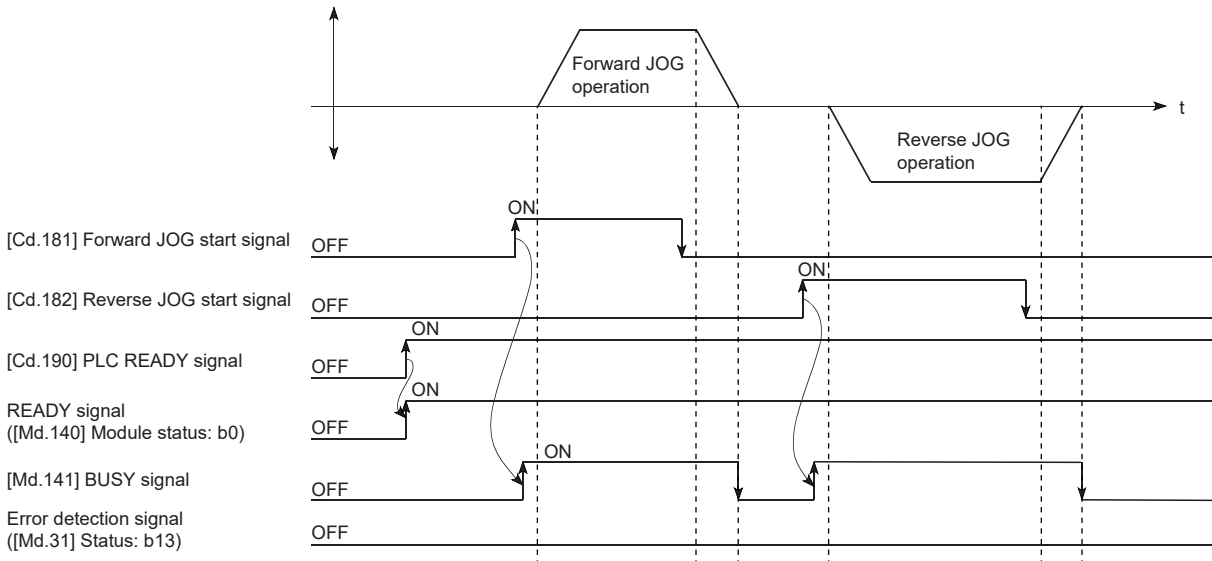

Program example

For the program example of the JOG operation, refer to the following.

- ☞ Page 504 JOG operation setting program
- ☞ Page 504 JOG operation/inching operation execution program

Operation example of the JOG operation

Example 1

When Stop signal is turned on during the JOG operation, the deceleration stop is executed and the JOG operation will stop. When JOG start signal is turned on while Stop signal is turned on, Stop signal ON at start (Error code: 1908H) occurs. The operation can be started when Stop signal is turned off and JOG start signal is off and on again.

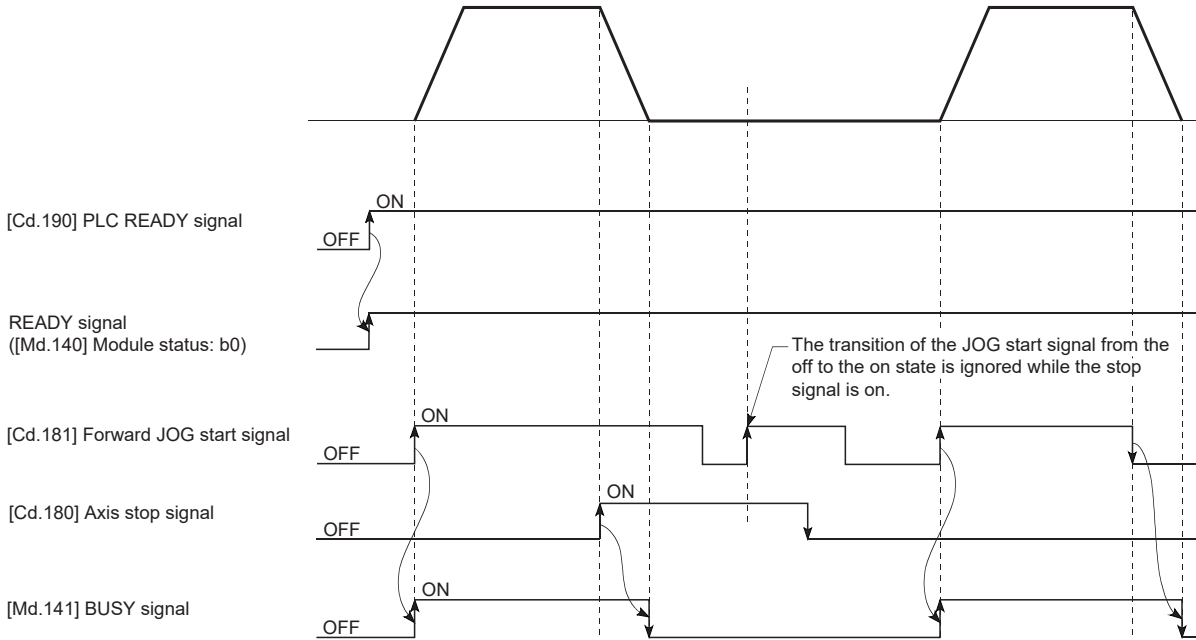

Example 2

When both Forward run JOG start signal and Reverse run JOG start signal are turned on simultaneously for one axis, Forward run JOG start signal is given priority. In this case, Reverse run JOG start signal is validated when BUSY signal of the positioning module turns off. However, if the forward run JOG operation is stopped due to Stop signal or an axis error, the reverse run JOG operation is not performed even if Reverse run JOG start signal is turned on.

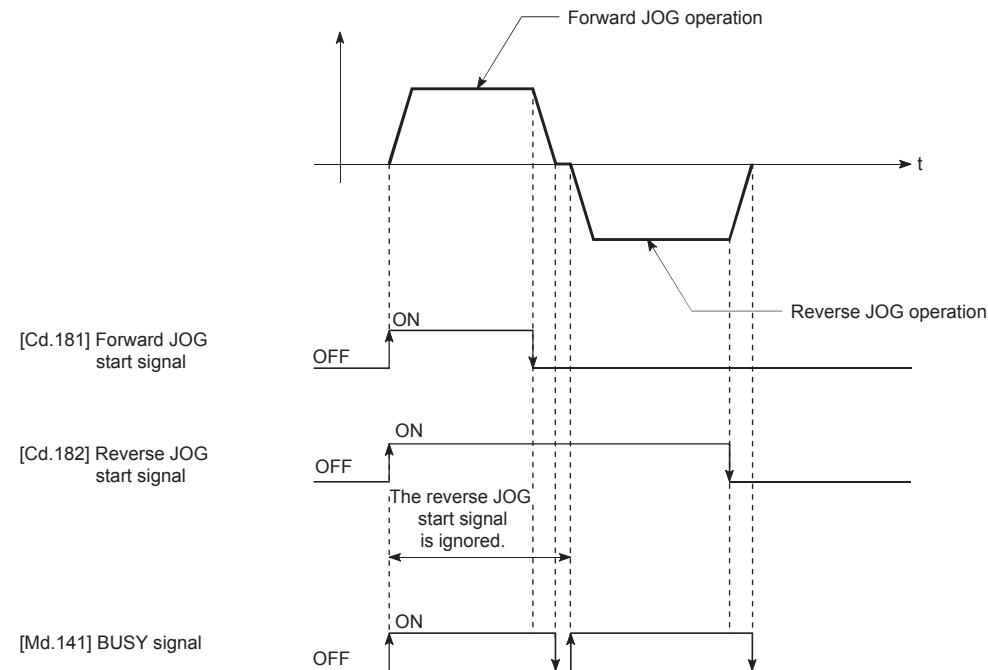

Example 3

When JOG start signal is turned on again during the deceleration due to turning off of JOG start signal, the JOG operation is performed from the point when JOG start signal is turned on.

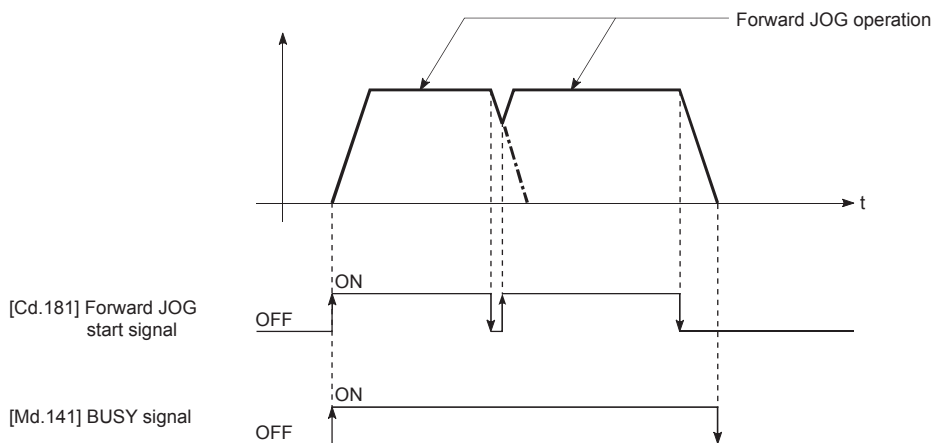

Example 4

If JOG start signal is turned on while using GX Works3 test mode, JOG start signal is ignored and the JOG operation is not performed.

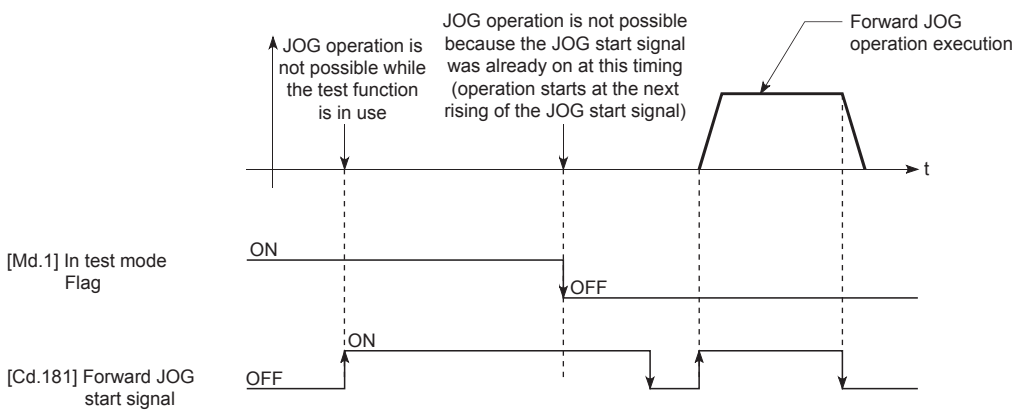

11.3 Inching Operation

Operation overview of the inching operation



Use the hardware stroke limit function when performing the inching operation at a position close to the upper or lower limit. (Page 248 Hardware stroke limit function)

If the hardware stroke limit function is not used, the workpiece may be moved beyond the movement range resulting in an accident.

Operation

In the inching operation, pulses are output to the drive unit for 1.77 ms from when [Cd.181] Forward JOG start signal or [Cd.182] Reverse JOG start signal is turned on to move the workpiece the specified movement amount. The following shows an operation example of the inching operation.

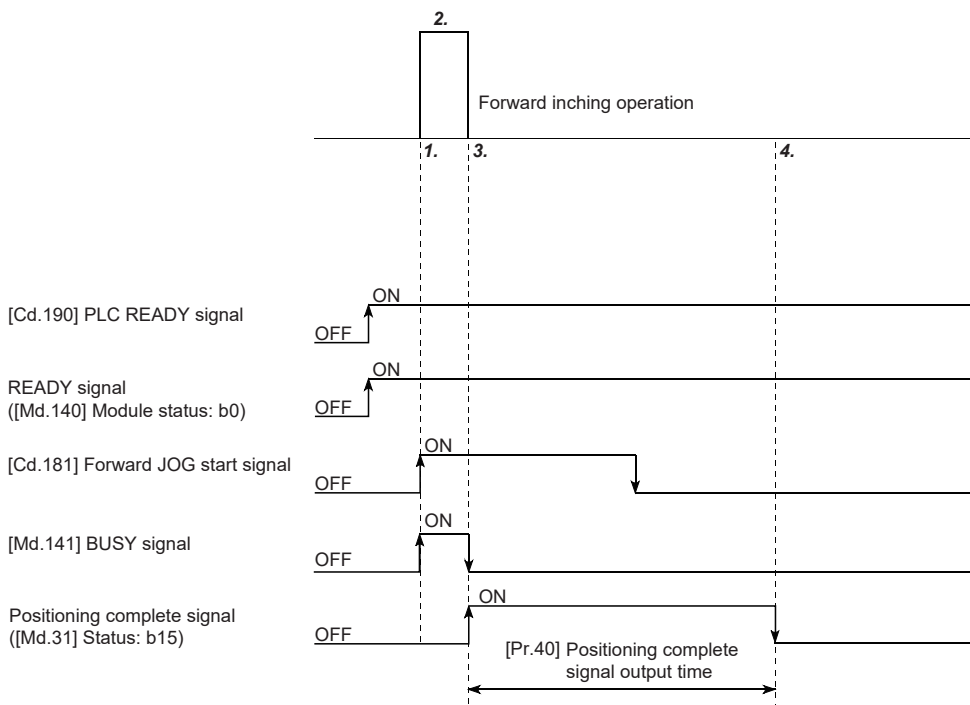

1. When a start signal is turned on, the inching operation is performed in the direction specified with the start signal. BUSY signal turns on at this time.
2. The workpiece moves for the movement amount set in [Cd.16] Inching movement amount.
3. Operation stops when the speed reaches 0. BUSY signal turns off at this time. Positioning complete signal turns on at the same time.
4. Positioning complete signal ([Md.31] Status: b15) turns off after the time set in "[Pr.40] Positioning complete signal output time" elapses.

Operation precautions

- The inching operation does not perform acceleration/deceleration processing. (Pulses for the specified inching movement amount are output at 1.77 ms. The direction of the inching operation is reversed. When the backlash compensation is performed, pulses for the backlash are output at 1.77 ms and pulses for the specified inching movement amount are output at the next 1.77 ms.) [Cd.17] JOG speed is ignored even if it is set. However, Inching movement amount error (Error code: 1981H) occurs in the following cases.

Unit	Error condition
pulse	$[(\text{Cd.16 Inching movement amount}) \times 562.5 > (\text{Pr.31 JOG speed limit value})]$
Other than pulse	$[(\text{Cd.16 Inching movement amount}) \times 337.5 > (\text{Pr.31 JOG speed limit value})]$

- Set a value other than 0 for [Cd.16] Inching movement amount. When 0 is set, the JOG operation is performed. (Page 196 JOG Operation)

Operation when a stroke limit error occurs

When the operation is stopped due to a hardware stroke limit error or software stroke limit error during the operation, the inching operation can be operated in the opposite direction (direction toward the normal range) after the error is reset. (If JOG start signal is turned on in the direction toward outside the limit range, the error occurs again.)

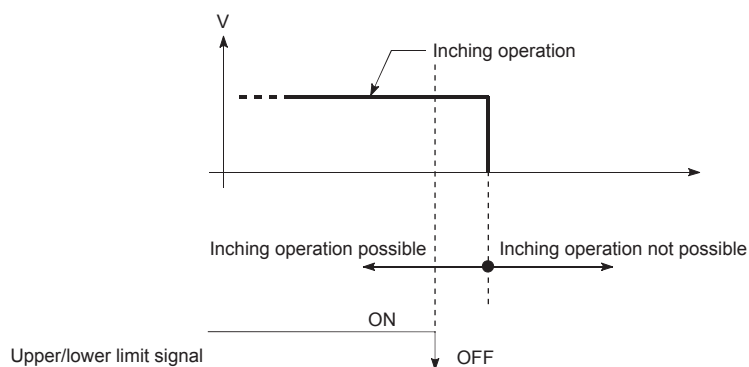

Operation timing and the processing time

The following shows the details on the operation timing and processing time in the inching operation.

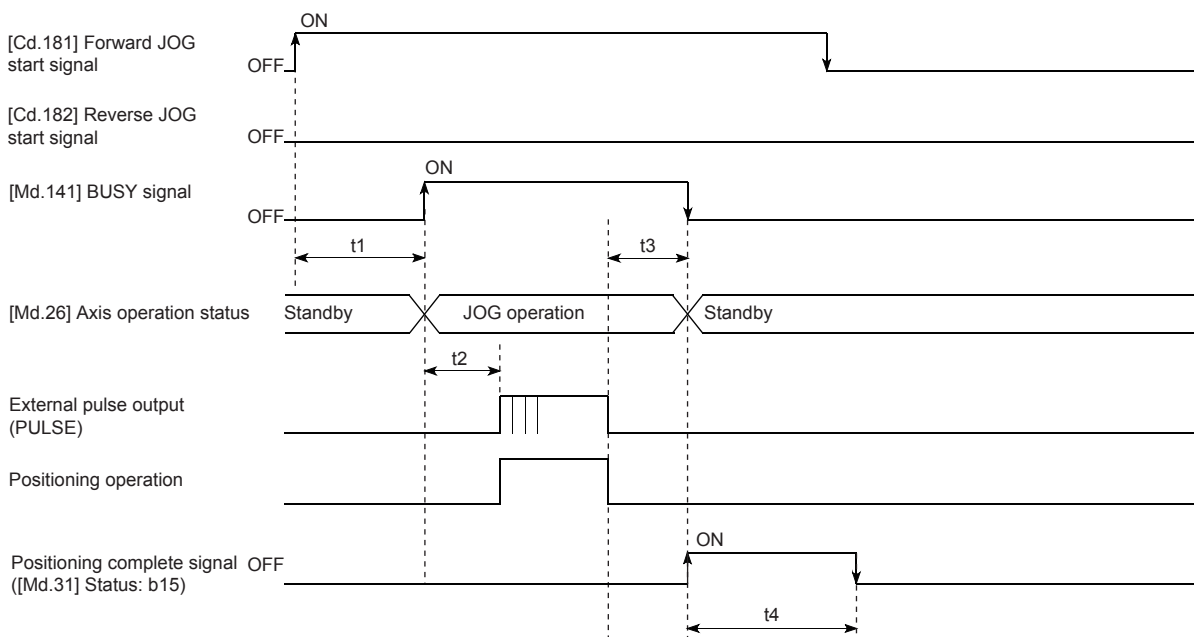

Normal timing time

t1	t2	t3	t4
1.0 to 3.0 ms	1.3 to 2.2 ms	1.3 to 2.2 ms	Depends on the parameter

Operation procedure of the inching operation

The inching operation is performed in the following procedure.

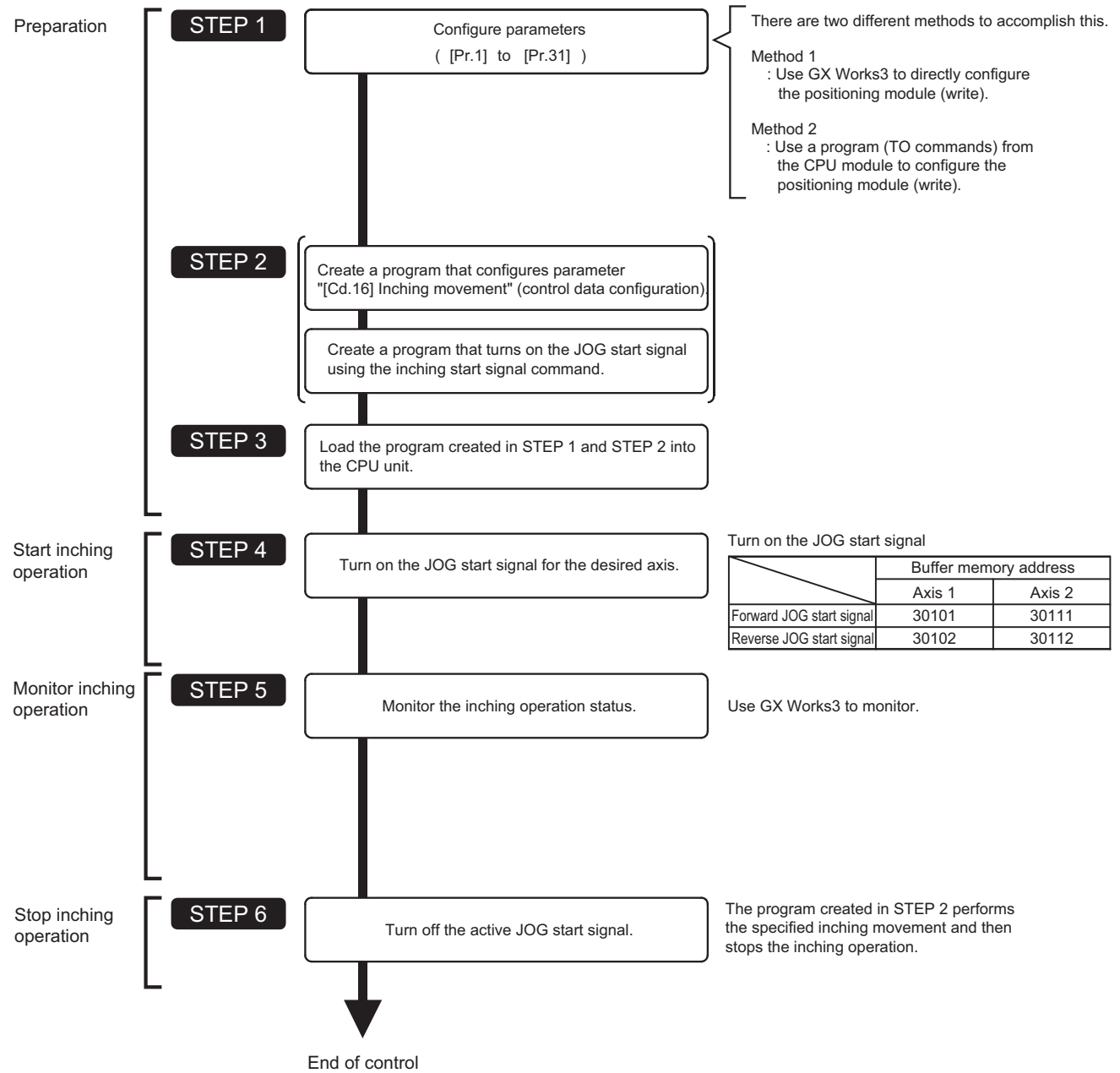

Point

- Mechanical elements such as limit switches are considered as already installed.
- Setting parameters is the common operation for all controls using the positioning module.

Parameters required for the inching operation

To perform the inching operation, parameters must be set. The following table shows the required parameters for performing the inching operation. When only the inching operation is performed, parameters not described below are not required. (Set the value within the setting range, such as the initial value.)

◎: Always set

○: Set as required (set a value within the setting range such as the initial value when the item is not used.)

Setting item			Setting requirement
Parameter	[Pr.1]	Unit setting	◎
	[Pr.2]	No. of pulses per rotation (Ap) (Unit: pulse)	◎
	[Pr.3]	Movement amount per rotation (Al) (Unit: pulse)	◎
	[Pr.4]	Unit magnification (Am)	◎
	[Pr.5]	Pulse output mode	◎
	[Pr.6]	Rotation direction setting	◎
	[Pr.8]	Speed limit value (Unit: pulse/s)	○
	[Pr.11]	Backlash compensation amount (Unit: pulse)	○
	[Pr.12]	Software stroke limit upper limit value (Unit: pulse)	○
	[Pr.13]	Software stroke limit lower limit value (Unit: pulse)	○
	[Pr.14]	Software stroke limit selection	○
	[Pr.15]	Software stroke limit valid/invalid setting	○
	[Pr.17]	Torque limit setting value (Unit: %)	○
	[Pr.23]	Output signal logic selection	○
	[Pr.31]	JOG speed limit value (Unit: pulse/s)	◎

Point

- Setting parameters is the common operation for all controls using the positioning module. When performing another control (Major positioning control, Advanced positioning control, or OPR control), configure the setting items required for the control.
- Parameters are set for each axis.
- For details on the settings, refer to the following.

 Page 385 Basic Setting

Creating a start program for the inching operation

To perform the inching operation, create a program. When creating a program, consider Control data requiring settings, Start condition, and Start time chart. The following shows an example when the inching operation is started for the axis 1. ([Cd.16] Inching movement amount is set to 10.0 μm .)

Control data requiring settings

The following control data must be set to execute the inching operation. The setting is executed with a program.

Setting item		Setting value	Setting detail	Buffer memory address	
				Axis 1	Axis 2
[Cd.16]	Inching movement amount	100	Set a setting value so that the command pulse is not larger than the maximum output pulse. ■Maximum output pulse • FX5-20PG-P: 200 kpulse/s • FX5-20PG-D: 5 Mpulse/s	1517	1617

For details on the settings, refer to the following.

☞ Page 474 [Cd.16] Inching movement amount

Start condition

Satisfy the following conditions to start a program. In addition, set the required conditions in the program to prevent an operation from starting if the conditions are not satisfied.

Signal name		Signal status		Device
Interface signal	PLC READY signal	ON	The CPU module is ready.	[Cd.190] PLC READY signal
	READY signal	ON	Positioning module READY.	[Md.140] Module status.b0
	Module access flag ^{*1}	ON	Positioning module buffer memory access allowed.	[Md.140] Module status.b1
	Axis stop signal	OFF	Axis stop signal is off.	[Cd.180] Axis stop signal
	Start complete signal	OFF	Start complete signal is off.	[Md.31] Status.b14
	BUSY signal	OFF	Positioning module inactive.	[Md.141] BUSY signal
	Positioning complete signal	OFF	Positioning complete signal is off.	[Md.31] Status.b15
	Error detection signal	OFF	No error has been detected.	[Md.31] Status.b13
M code ON signal	OFF	M code ON signal is off.	[Md.31] Status.b12	
External signal	Drive unit READY signal	ON	The drive unit is ready.	—
	Stop signal	OFF	Stop signal is off.	—
	Upper limit (FLS)	ON	The current position is within the limit.	—
	Lower limit (RLS)	ON	The current position is within the limit.	—

*1 To access the buffer memory, the interlock must be provided so that the buffer memory can be accessed after Module access flag ([Md.140] Module status: b1) turns on. When no interlock is provided, the buffer memory may be accessed while the module parameter and module extension parameter that are sent from the CPU module are updated. If the buffer memory is accessed during the update, an unexpected value may be read or written.

Start time chart

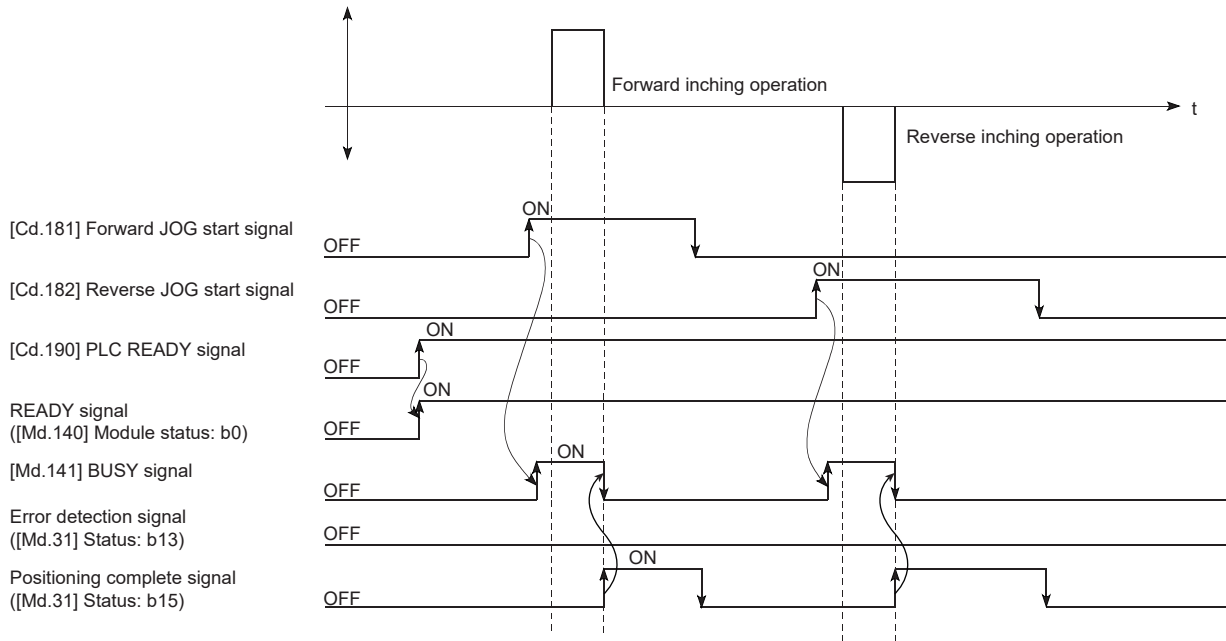

Program example

For the program example of the inching operation, refer to the following.

- ☞ Page 504 JOG operation setting program
- ☞ Page 504 JOG operation/inching operation execution program

Operation example of the inching operation

Example 1

When JOG start signal is turned on while Stop signal is turned on, Stop signal ON at start (Error code: 1908H) occurs. The operation can be started when Stop signal is turned off and JOG start signal is off and on again.

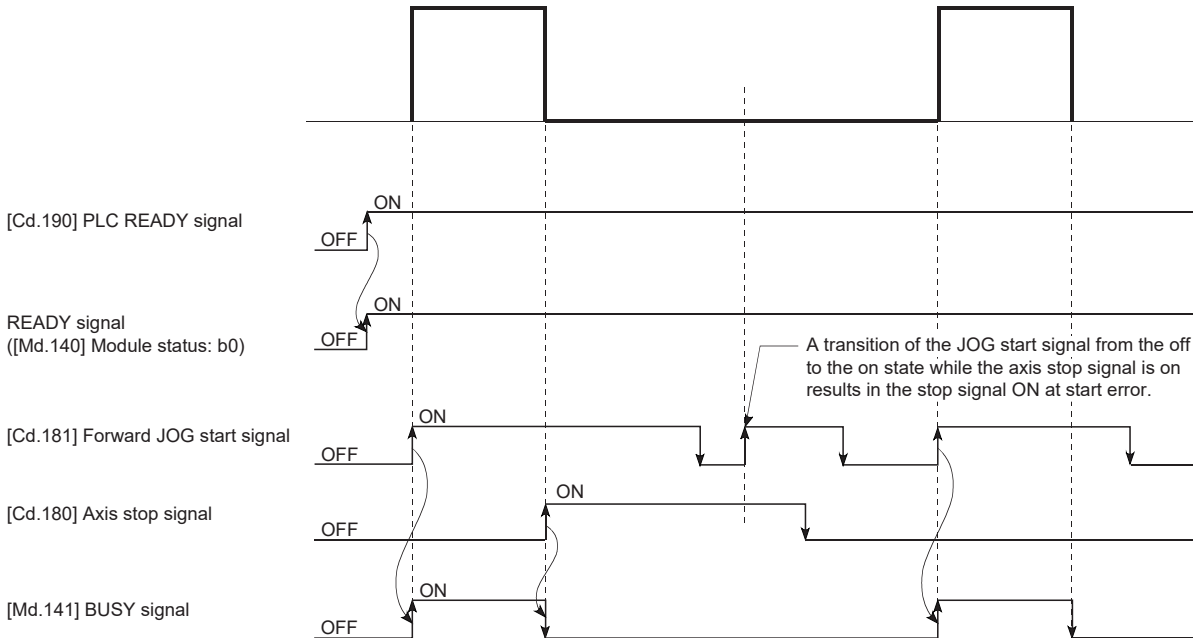

Example 2

If JOG start signal is turned on while using GX Works3 test mode, JOG start signal is ignored and the inching operation is not performed.

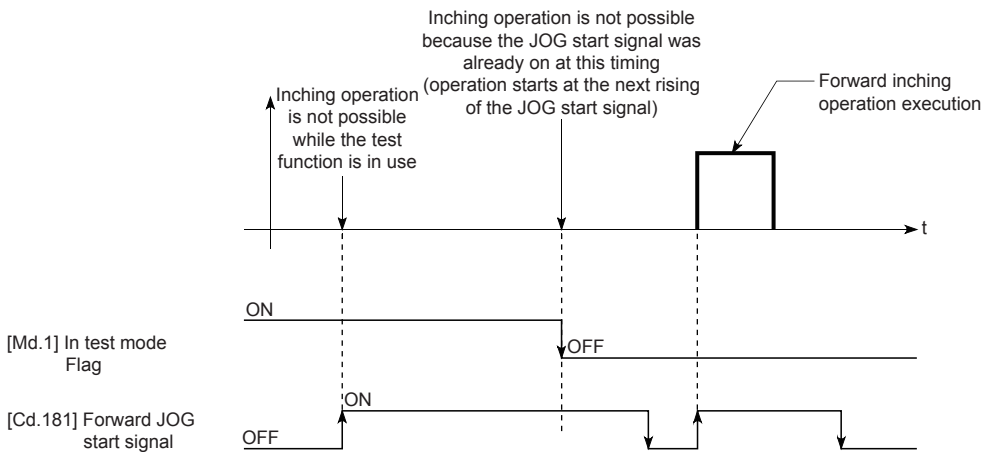

11.4 Manual Pulse Generator Operation

Operation overview of the manual pulse generator operation



When the manual pulse generator operation is not performed, create a program in which [Cd.21] Manual pulse generator enable flag is always 0 (disabled). Touching the manual pulse generator when [Cd.21] Manual pulse generator enable flag is 1 (enabled) may cause an accident or incorrect positioning.

Operation

In the manual pulse generator operation, pulses are input from the manual pulse generator to the positioning module, and output from the positioning module to the servo amplifier for the number of the input pulses and to move the workpiece in the specified direction. The following shows an operation example of the manual pulse generator operation.

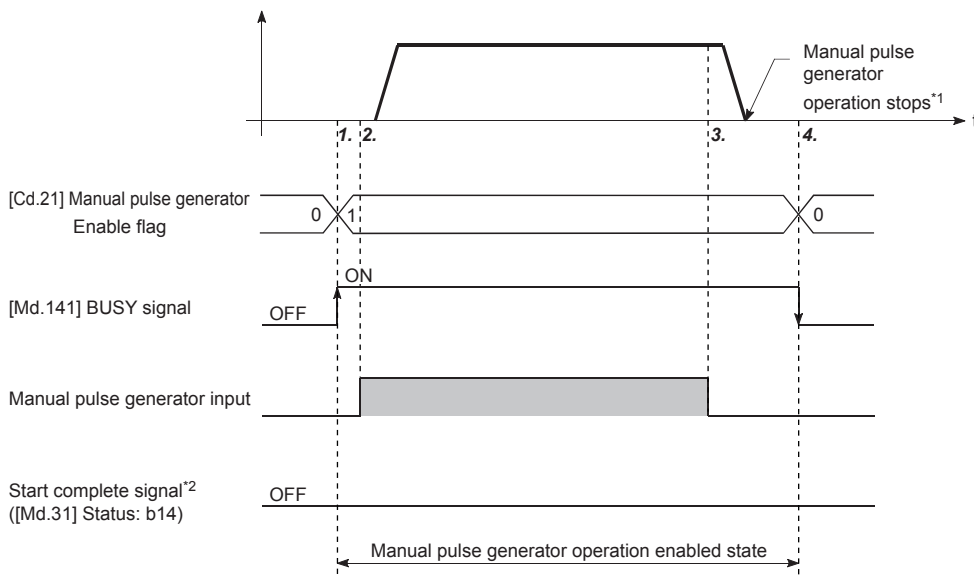

1. When [Cd.21] Manual pulse generator enable flag is set to 1, BUSY signal turns on and the manual pulse generator operation is enabled.
2. The workpiece is moved for the number of pulses input from the manual pulse generator.
3. The workpiece movement stops when no pulse is input from the manual pulse generator.
4. When [Cd.21] Manual pulse generator enable flag is set to 0, BUSY signal turns off and the manual pulse generator operation is disabled.

*1 If the input from the manual pulse generator stops, the machine decelerates and stops within 90 ms. If [Cd.21] Manual pulse generator enable flag is set to 0 during the manual pulse generator operation, the machine decelerates and stops within 90 ms.

*2 Start complete signal does not turn on in the manual pulse generator operation.

Restrictions

- A manual pulse generator is required to perform the manual pulse generator operation.
- Do not use manual pulse generator operation when another axis is in pre-analysis mode. This is because pulses may be output at unintended timings for axes subject to manual pulse generator operation.

Precautions during the operation

The following details must be understood before performing the manual pulse generator operation.

- The speed during the manual pulse generator operation is not limited with [Pr.8] Speed limit value. For this reason, configure [Cd.20] Manual pulse generator 1 pulse input magnification such that the output command frequency is Maximum output frequency or less (FX5-20PG-P: 200 kpulse/s, FX5-20PG-D: 5 Mpulse/s).
- If [Cd.21] Manual pulse generator enable flag is turned on while the positioning module is busy (BUSY signal is on), Start during operation (Warning code: 0900H) occurs.
- If a stop factor occurs during the manual pulse generator operation, the operation stops and BUSY signal turns off. At this time, [Cd.21] Manual pulse generator enable flag remains on, but the manual pulse generator operation cannot be performed. To perform the manual pulse generator operation again, take measures to eliminate the stop factor and turn off and on [Cd.21] Manual pulse generator enable flag. (Note that this excludes when a hardware/software stroke limit error occurs.)
- Pulses are not output if an error occurs when the manual pulse generator operation is started.

Point

- One positioning module can be connected to one manual pulse generator.
- The positioning module can simultaneously output pulses to axis 1 and axis 2 drive units using one manual pulse generator. (1/2 axis simultaneous operation is possible.)

Operation when a stroke limit error occurs

When a hardware stroke limit error or a software stroke limit error is detected during the operation^{*1}, the deceleration stop is performed. However, the status of [Md.26] Axis operation status remains in Manual pulse generator operation^{*1} in this case. After the operation has stopped, the manual pulse generator input pulses in the direction toward outside the limit range are not accepted, but the operation in the direction toward the range can be executed.

*1 Only when the current feed value or the machine feed value overflows or underflows during the deceleration, the status of [Md.26] Axis operation status is changed to Error and the manual pulse generator operation terminates. To perform the manual pulse generator operation again, turn off [Cd.21] Manual pulse generator enable flag once and turn on.

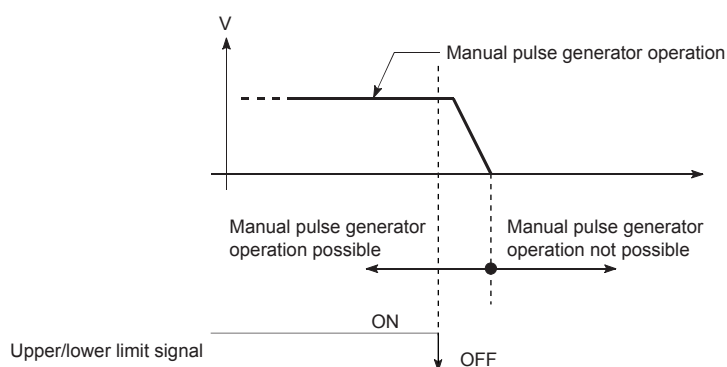

Operation timing and the processing time

The following shows the details on the operation timing and processing time in the manual pulse generator operation.

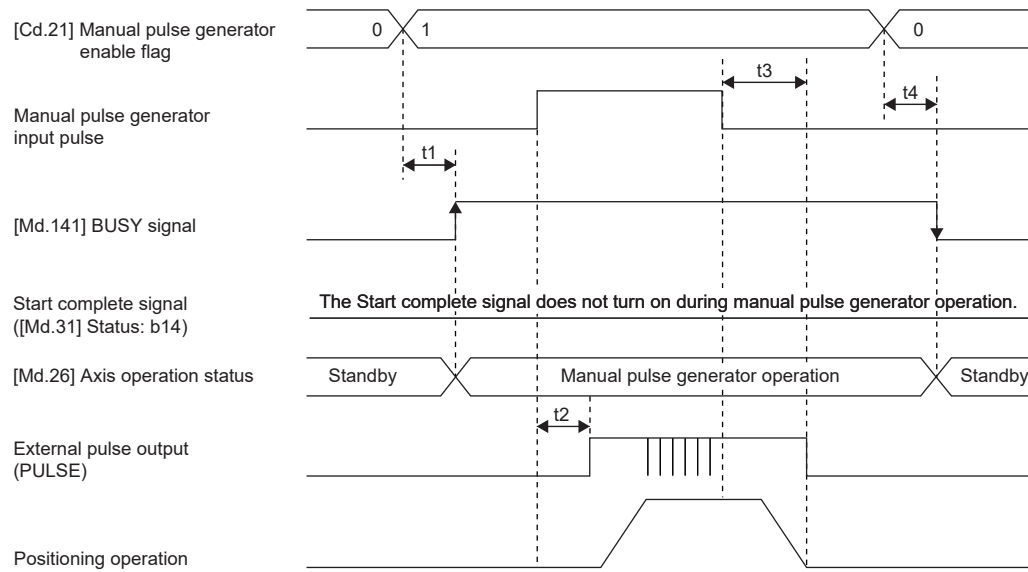

Normal timing time

t1	t2	t3	t4
0 to 0.88 ms	1.7 to 30.2 ms	58.6 to 87.6 ms	32.0 to 61.3 ms

Position control by the manual pulse generator operation

In the manual pulse generator operation, the position is moved for Manual pulse generator 1 pulse movement amount per pulse. The current feed value in the positioning control by the manual pulse generator operation can be calculated using the following calculation formula.

Current feed value = Number of input pulses × [Cd.20] Manual pulse generator 1 pulse input magnification × Manual pulse generator 1 pulse movement amount

[Pr.1] Unit setting	mm	inch	degree	pulse
Manual pulse generator 1 pulse movement amount	0.1 μm	0.00001 inch	0.00001 degree	1 pulse

For example, when [Pr.1] Unit setting is mm and [Cd.20] Manual pulse generator 1 pulse input magnification is 2, 100 pulses are input from the manual pulse generator and the current feed value is as follows.

$$100 \times 2 \times 0.1 = 20 [\mu\text{m}] = 200 [\text{Current feed value}]$$

The number of pulses output actually to the drive unit is (Manual pulse generator 1 pulse movement amount/Movement amount per pulse).

The movement amount per pulse is given by the following calculation formula.

$$\text{Movement per pulse (A)} = \frac{Al \times Am}{Ap}$$

Item	Symbol
[Pr.2] No. of pulses per rotation	Ap
[Pr.3] Movement amount per rotation	Al
[Pr.4] Unit magnification	Am
Movement amount per pulse	A

For example, when [Pr.1] Unit setting is mm and the movement amount per pulse is 1 μm, $0.1/1 = 1/10$, that is, the number of pulses output to the drive unit from the manual pulse generator per pulse is 1/10 pulse. Thus, the positioning module outputs 1 pulse to the drive unit after receiving 10 pulses from the manual pulse generator.

Speed control by the manual pulse generator operation

The speed during the positioning control by the manual pulse generator operation depends on the number of input pulses per unit time, and can be calculated using the following calculation formula.

Output command frequency = Input frequency × [Cd.20] Manual pulse generator 1 pulse input magnification

Operation procedure of the manual pulse generator operation

The manual pulse generator operation is performed in the following procedure.

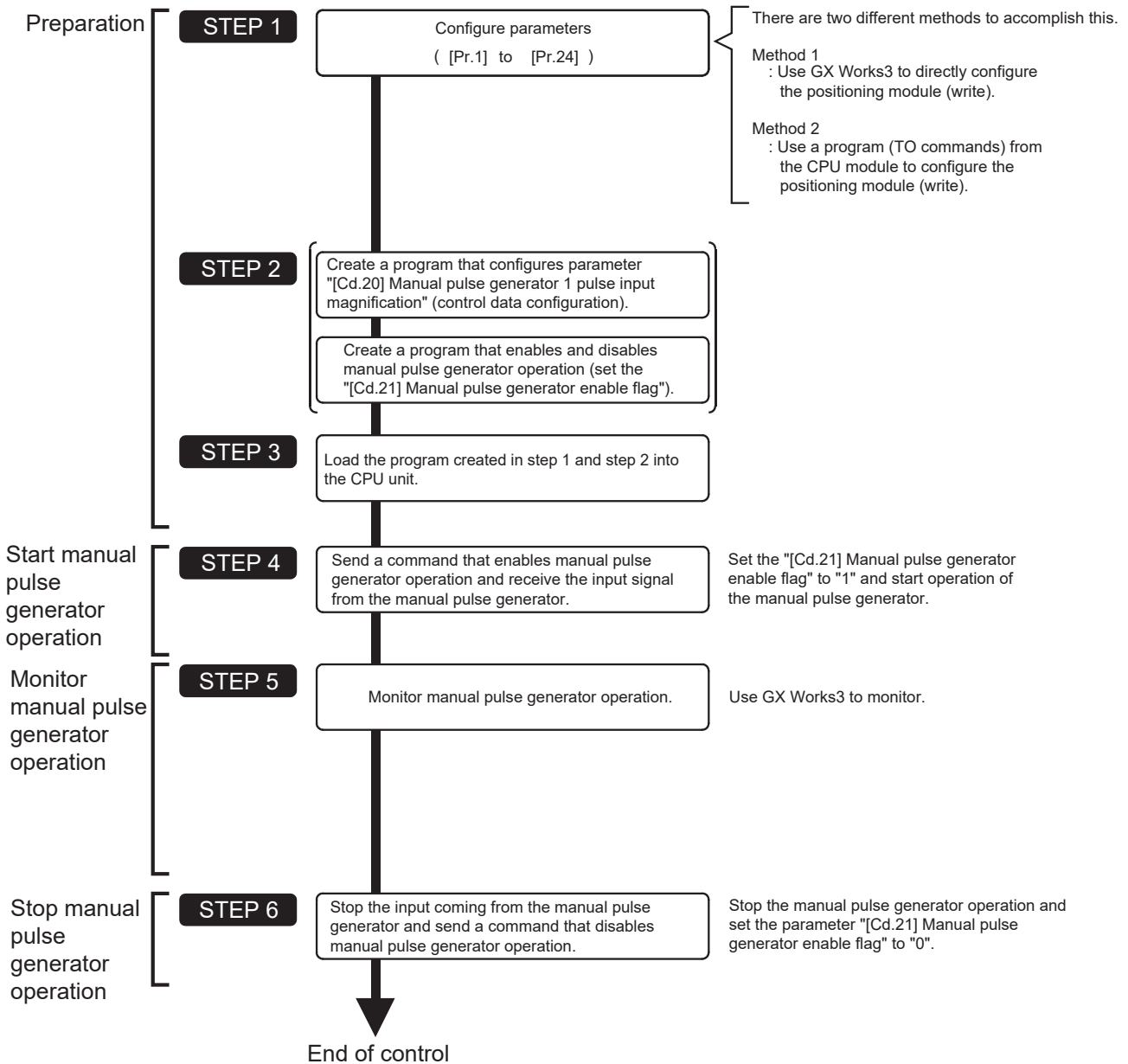

Point

- Mechanical elements such as limit switches are considered as already installed.
- Setting parameters is the common operation for all controls using the positioning module.

Parameters required for the manual pulse generator operation

To perform the manual pulse generator operation, parameters must be set. The following table shows the required parameters for performing the manual pulse generator operation. When only the manual pulse generator operation is performed, parameters not described below are not required. (Set the value within the setting range, such as the initial value.)

◎: Always set

○: Set as required (set a value within the setting range such as the initial value when the item is not used.)

Setting item			Setting requirement
Parameter	[Pr.1]	Unit setting	◎
	[Pr.2]	No. of pulses per rotation (Ap) (Unit: pulse)	◎
	[Pr.3]	Movement amount per rotation (Al) (Unit: pulse)	◎
	[Pr.4]	Unit magnification (Am)	◎
	[Pr.5]	Pulse output mode	◎
	[Pr.6]	Rotation direction setting	◎
	[Pr.11]	Backlash compensation amount (Unit: pulse)	○
	[Pr.12]	Software stroke limit upper limit value (Unit: pulse)	○
	[Pr.13]	Software stroke limit lower limit value (Unit: pulse)	○
	[Pr.14]	Software stroke limit selection	○
	[Pr.15]	Software stroke limit valid/invalid setting	○
	[Pr.17]	Torque limit setting value (Unit: %)	○
	[Pr.22]	Input signal logic selection	○
	[Pr.23]	Output signal logic selection	○
	[Pr.24]	Manual pulse generator input selection	○

Point 

- Setting parameters is the common operation for all controls using the positioning module. When performing another control (Major positioning control, Advanced positioning control, or OPR control), configure the setting items required for the control.
- Parameters are set for each axis. However, the manual pulse generator input logic (b8) of [Pr.22] and [Pr.24] are set only for the axis 1. (The setting for the axis 2 is ignored.)
- For details on the settings, refer to the following.

 Page 385 Basic Setting

Creating a program to enable or disable the manual pulse generator operation

To perform the manual pulse generator operation, create a program. When creating a program, consider Control data requiring settings, Start condition, and Start time chart. The following shows an example when the manual pulse generator operation is started for the axis 1.

Control data requiring settings

The following control data must be set to execute the manual pulse generator operation. The setting is executed with a program.

Setting item		Setting value	Setting detail	Buffer memory address	
				Axis 1	Axis 2
[Cd.20]	Manual pulse generator 1 pulse input magnification	1	Set the manual pulse generator 1 pulse input magnification (1 to 10000 times).	1522 1523	1622 1623
[Cd.21]	Manual pulse generator enable flag	1 (0)	Set 1: Enable manual pulse generator operation. (When the manual pulse generator operation is not performed, set 0: Disable manual pulse generator operation.)	1524	1624

For details on the settings, refer to the following.

☞ Page 475 [Cd.20] Manual pulse generator 1 pulse input magnification

☞ Page 476 [Cd.21] Manual pulse generator enable flag

Start condition

Satisfy the following conditions to start a program. In addition, set the required conditions in the program to prevent an operation from starting if the conditions are not satisfied.

Signal name		Signal status		Device
Interface signal	PLC READY signal	ON	The CPU module is ready.	[Cd.190] PLC READY signal
	READY signal	ON	Positioning module READY.	[Md.140] Module status.b0
	Module access flag ^{*1}	ON	Positioning module buffer memory access allowed.	[Md.140] Module status.b1
	Axis stop signal	OFF	Axis stop signal is off.	[Cd.180] Axis stop signal
	Start complete signal	OFF	Start complete signal is off.	[Md.31] Status.b14
	BUSY signal	OFF	Positioning module inactive.	[Md.141] BUSY signal
	Error detection signal	OFF	No error has been detected.	[Md.31] Status.b13
	M code ON signal	OFF	M code ON signal is off.	[Md.31] Status.b12
External signal	Drive unit READY signal	ON	The drive unit is ready.	—
	Stop signal	OFF	Stop signal is off.	—
	Upper limit (FLS)	ON	The current position is within the limit.	—
	Lower limit (RLS)	ON	The current position is within the limit.	—

*1 To access the buffer memory, the interlock must be provided so that the buffer memory can be accessed after Module access flag ([Md.140] Module status: b1) turns on. When no interlock is provided, the buffer memory may be accessed while the module parameter and module extension parameter that are sent from the CPU module are updated. If the buffer memory is accessed during the update, an unexpected value may be read or written.

Start time chart

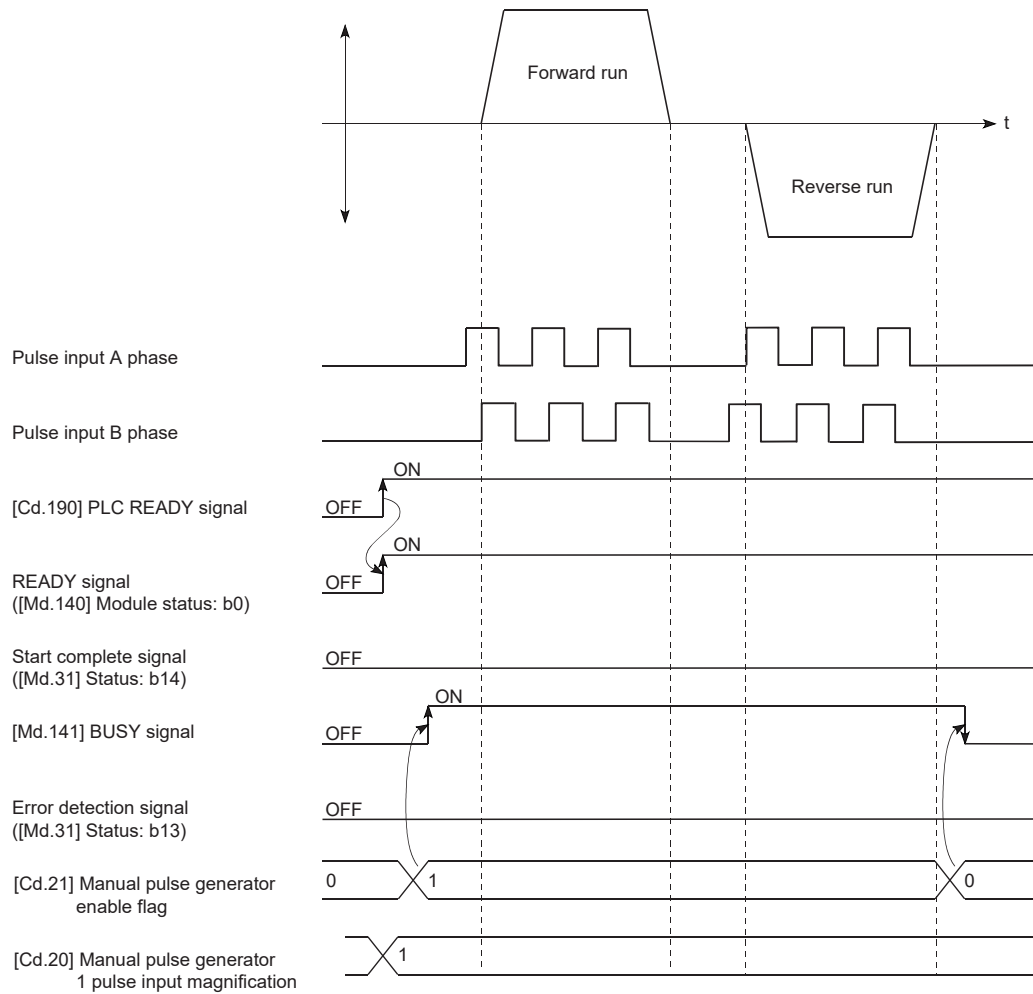

Program example

For the program example of the manual pulse generator operation, refer to the following.

☞ Page 505 Manual pulse generator operation program

12 CONTROL SUB FUNCTION

This chapter describes the details and usage of Sub function added and used in combination with the main functions. A variety of sub functions, including sub functions specific to machine OPR and generally related functions such as control compensation, are available. More appropriate and finer control can be performed by using these sub functions. Each sub function is used together with a main function by setting parameters or creating programs. Check the settings and execution procedures for each sub function, and configure each setting as required.

12.1 Overview of Sub Functions

Sub functions compensate or limit the control, or add functions to the control at the execution of a main function. These sub functions are executed by setting parameters, issuing commands from GX Works3, or using a program for sub functions.

Overview of Sub Functions

The following table shows sub functions.

Sub function		Description
Sub functions specific to machine OPR	OPR retry function	Retries the machine OPR with the upper/lower limit switches during the machine OPR. This allows the machine OPR to be performed even if the axis is not returned to a position before the near-point dog with operations such as the JOG operation.
	OP shift function	After the machine OPR, this function compensates the position by the specified distance from the machine OP position and sets that position as the OP address.
Function to Compensate Control	Backlash compensation function	Compensates the backlash amount of the machine system. Feed pulses equivalent to the set backlash amount are output each time the movement direction changes.
	Electronic gear function	By setting the movement amount per pulse, this function can freely change the machine movement amount per commanded pulse. A flexible positioning system that matches the machine system can be structured with this function.
	Near pass function ^{*1}	Suppresses the machine vibration when positioning data is switched during the continuous path control in the interpolation control.
	Output timing selection of near pass control	This function allows the user to select the timing to output the difference (Δd) between the actual and the set positioning end addresses in the continuous path control, in which the difference (d) is output during the execution of the next positioning data.
Function to limit control	Speed limit function	If the command speed exceeds [Pr.8] Speed limit value during the control, this function limits the command speed to within the setting range of [Pr.8] Speed limit value.
	Torque limit function ^{*2}	If the torque generated by the servo motor exceeds [Pr.17] Torque limit setting value during the control, this function limits the generated torque to within the setting range of [Pr.17] Torque limit setting value.
	Software stroke limit function	If a command outside of the upper/lower limit stroke limit setting range, set in the parameters, is issued, this function will not execute the positioning for that command.
	Hardware stroke limit function	Performs the deceleration stop with the limit switch connected to the positioning module connector for external devices.
Functions that Change Control Details	Speed change function	Changes the speed during positioning. Set the new speed in the speed change buffer memory area ([Cd.14] New speed value) and change the speed with [Cd.15] Speed change request.
	Override function	Changes the speed during positioning within a percentage of 0 to 300%. Execute this function using [Cd.13] Positioning operation speed override.
	Acceleration/ deceleration time change function	Changes the acceleration/deceleration time at the speed change (function added to the speed change function and override function).
	Torque change function	Changes Torque limit value during the control.
	Target position change function	Changes the target position during positioning. The position and speed can be changed simultaneously.
Function related to positioning start	Pre-reading start function	If the positioning start is requested while Execution prohibition flag is on, no pulse is output, and when Execution prohibition flag is turned off and detected, outputting pulses is started within 0.88 ms.
	Start time adjustment function	After the start trigger was input with the quick start function, this function starts outputting pulses after the preset time has passed.
Absolute position restoration function ^{*3}		Restores the absolute position of a specified axis. The OPR after the system is powered on is not required once the OPR is executed at the startup of the system.

Sub function		Description
Function related to positioning stop	Stop command processing for deceleration stop function	Selects a deceleration curve when a stop cause occurs during the deceleration stop processing to speed 0.
	Continuous operation interrupt function	Interrupts the continuous operation. When this request is accepted, the operation will stop at the completion of the positioning data being executed.
	Step function	Temporarily stops the operation to check the positioning operation during debugging and other operation. The operation can be stopped for each Automatic deceleration or Positioning data.
Other functions	Skip function	Pauses (decelerates to stop) the positioning being executed when Skip signal is input, and performs the next positioning.
	M code output function	Issues a command for a subsidiary work (such as stopping clamps or drills and changing tools) corresponding to each M code number (0 to 65535) that can be set to each positioning data.
	Teaching function	Stores the address positioned with the manual control in [Da.6] Positioning address/movement amount of the specified positioning data No.
	Command in-position function	Calculates the remaining distance for the positioning module to reach the positioning stop position for each automatic deceleration, and sets Command in-position flag to 1 when the value is less than the set value. When performing another subsidiary work before the control ends, use this function as a trigger for the subsidiary work.
	Acceleration/ deceleration processing function	Adjusts acceleration/deceleration (acceleration/deceleration time and curve) of the control.
	Deceleration start flag function	To inform the stop timing, this function turns on Deceleration start flag when the speed status is changed from the constant speed or acceleration to deceleration during the position control whose operation pattern is Positioning complete.
	During uncompleted OPR operation setting function	Sets whether or not to execute the positioning control when OPR request flag is on.
Interrupt function	Generates an interrupt request to the CPU module when an interrupt factor is detected, and starts an interrupt program.	

- *1 The near pass function is featured as standard and is valid only when the continuous path control for position control operations is set. The function cannot be set to be invalid with parameters.
- *2 To perform Torque limit, a D/A converter module and a drive unit capable of the torque limit command with an analog voltage must be needed.
- *3 An I/O module with arbitrary number of points and a drive unit capable of configuring an absolute position detection system (which is a Mitsubishi General-Purpose AC Servo and has an absolute position detection function (absolute position data transfer protocol) equivalent to that of MR- J4-□A) are needed.

12.2 Sub Functions Specific to Machine OPR

The sub functions specific to machine OPR include OPR retry function and OP shift function. Each function is executed based on the parameter setting.

OPR retry function

If a workpiece passes over the OP without stopping during the position control, the workpiece may not move back in the direction of the OP although the machine OPR is commanded, depending on the workpiece position. In this case, the workpiece has to be moved to a position before the near-point dog by the JOG operation or other operations to start the machine OPR again. However, by using the OPR retry function, the machine OPR can be performed regardless of the workpiece position.

Control details

The following shows the operation of the OPR retry function.

■OPR retry operation when the workpiece is within the range between the upper/lower limits

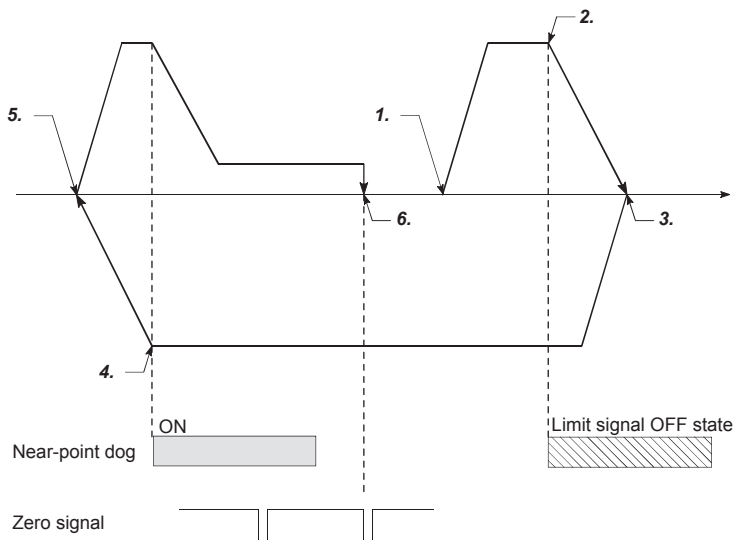

1. The movement starts in the direction set in [Pr.44] OPR direction by Machine OPR start.
2. The operation decelerates when Limit signal OFF is detected.
3. After the operation has stopped due to the detection of Limit signal OFF, the operation moves at the speed set in [Pr.46] OPR speed in the direction opposite to the direction set in [Pr.44] OPR direction.
4. The operation decelerates when Near-point dog signal is turned off.
5. After the operation has stopped due to turning off of Near-point dog signal, the machine OPR is performed in the direction set in [Pr.44] OPR direction.
6. Machine OPR is completed.

■OPR retry operation when the workpiece is outside the range between the upper/lower limits

- When the direction from the workpiece to the OP is the same as the direction set in [Pr.44] OPR direction, the normal machine OPR is performed. The following is an example of when [Pr.44] OPR direction is set to 0: Forward direction.

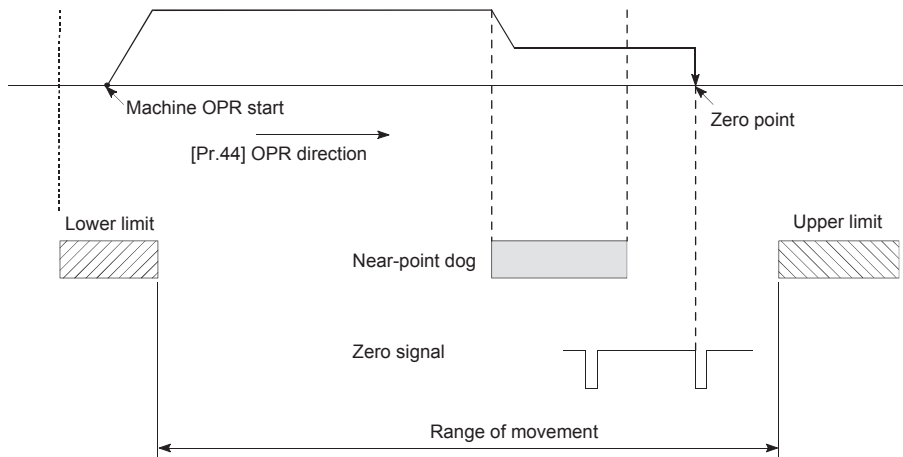

- When the direction from the workpiece to the OP is the opposite direction from the direction set in [Pr.44] OPR direction, the operation performs the deceleration stop when Near-point dog signal is turned off, and performs the machine OPR in the direction set in [Pr.44] OPR direction. The following is an example of when [Pr.44] OPR direction is set to 0: Forward direction.

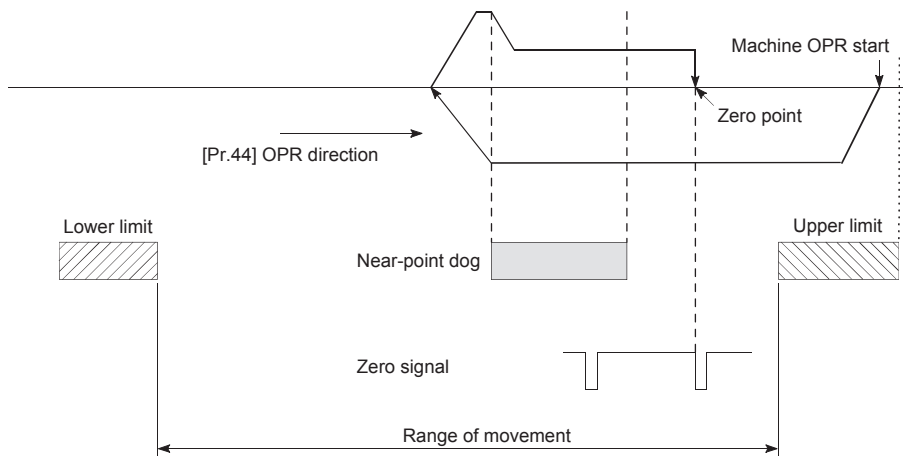

Point

- When [Pr.44] OPR direction is set to 0: Forward direction, check that the limit switch placed in the OPR direction works as the upper limit.
- When [Pr.44] OPR direction is set to 1: Reverse direction, check that the limit switch placed in the OPR direction works as the lower limit.
- Incorrect wiring of these limit switches may cause improper OPR retry operation.
- If any malfunction is identified, check and correct the wiring and the setting in [Pr.6] Rotation direction setting.

■Setting the dwell time during OPR retry

The OPR retry function can perform such a function as the dwell time using [Pr.57] Dwell time during OPR retry when the reverse run operation is performed due to the detection of Upper limit signal or Lower limit signal or when the machine OPR is executed after Near-point dog signal is turned off to stop the operation.

[Pr.57] Dwell time during OPR retry is validated when the operation stops at the positions of A and B in the following figure. (The dwell time is the same value at both the positions.)

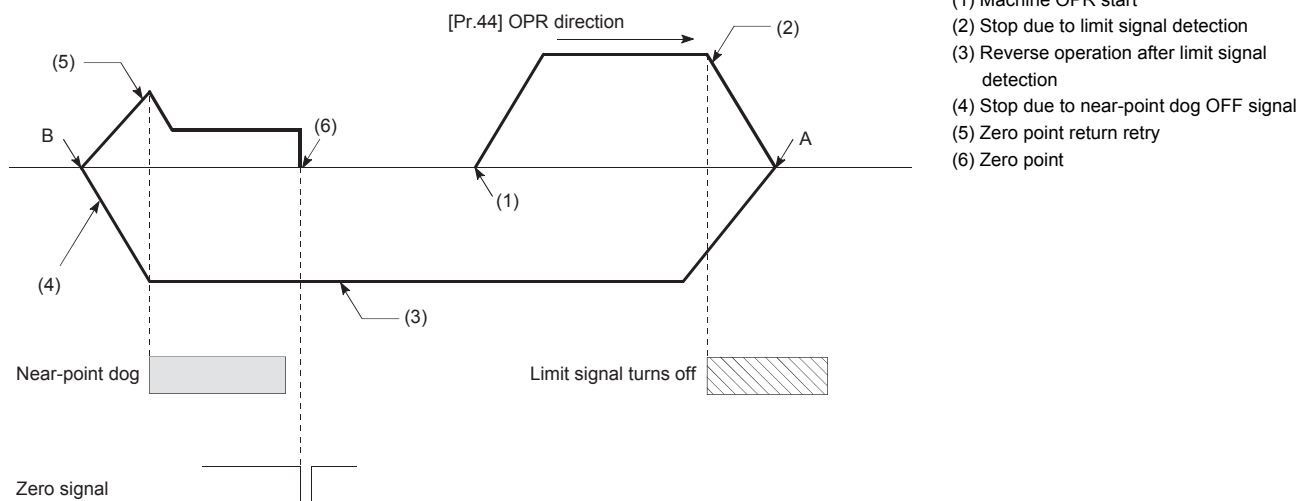

Control precautions

- The following table shows whether the OPR retry function can be executed or not by the method set in [Pr.43] OPR method.

[Pr.43] OPR method	Execution status of the OPR retry function
Near-point dog method	○: Execution possible
Stopper method 1	○: Execution possible ^{*1}
Stopper method 2	○: Execution possible ^{*1}
Stopper method 3	×: Execution not possible
Count method 1	○: Execution possible
Count method 2	○: Execution possible
Data setting method	×: Execution not possible
Limit switch combined-use method	×: Execution not possible

*1 Starting can be executed from the position of the limit switch installed in the opposition direction from the direction set in [Pr.44] OPR direction (Limit signal is off). However, since a stopper is set in the OPR direction, the retry operation in the OPR direction using the limit switch cannot be executed.

- Always establish upper/lower limit switches at the upper/lower limit positions of the machine, and connect them to the positioning module. If the OPR retry function is used without hardware stroke limit switches, the motor will continue rotation until a hardware stroke limit signal is detected.
- Do not configure a system in which the drive unit is powered off by the upper/lower limit switches connected to the positioning module. If the drive unit is powered off by the switches, the OPR retry cannot be performed.

Setting method

To use the OPR retry function, configure the required settings in the parameters shown in the following table, and write them to the positioning module.

When the parameters are set, the OPR retry function will be added to the machine OPR control. The settings are validated at the rising edge (when turned off and on) of [Cd.190] PLC READY signal. (Set [Pr.57] Dwell time during OPR retry as required.)

Setting item		Setting value	Setting detail	Initial value at the factory	Buffer memory address	
					Axis 1	Axis 2
[Pr.48]	OPR retry	1	Set 1: Perform OPR retry by limit switch.	0	78	228
[Pr.57]	Dwell time during OPR retry	→	Set the deceleration stop time during OPR retry. (Arbitrary value between 0 and 65535 [ms])	0	89	239

For details on the settings, refer to the following.

 Page 417 [Pr.48] OPR retry

 Page 422 [Pr.57] Dwell time during OPR retry

Point

- Parameters are set for each axis.
- Setting the parameters using GX Works3 is recommended. To perform the setting using programs, many programs and devices are required. The execution becomes complicated, and the scan times will increase.

OP shift function

When the machine OPR is performed, the OP is normally established using a near-point dog, stopper, and Zero signal. However, by using the OP shift function, the machine can be moved for a specified movement amount from the position where Zero signal was detected. The point moved from that position can be interpreted as a mechanically established OP. The OP shift function can be used regardless of the setting in [Pr.43] OPR method. The section explains the OP shift function.

Control details

The following figure shows the operation of the OP shift function.

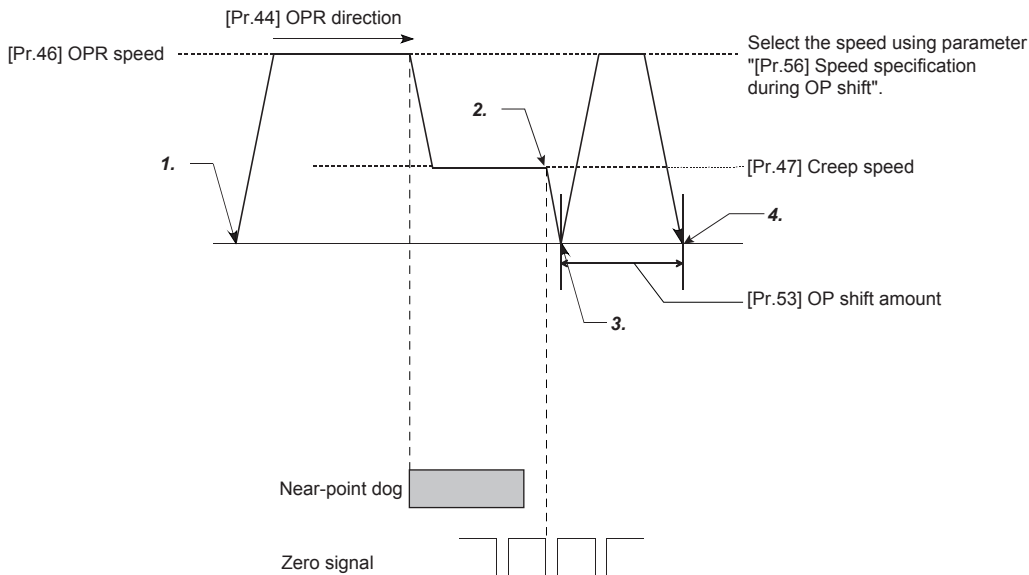

1. The OPR is performed in the direction set in [Pr.44] OPR direction by Machine OPR start.
2. The OPR operation stops when Zero signal is detected and outputs Deviation counter clear output to the drive unit.
3. After Deviation counter clear output is output, the OP shift operation is performed.
4. The position moved for the amount set in [Pr.53] OP shift amount is set as the OP, and the machine OPR is completed.

Setting range of the OP shift amount

Set the OP shift amount within the range from the detected zero signal to the upper/lower limit switches.

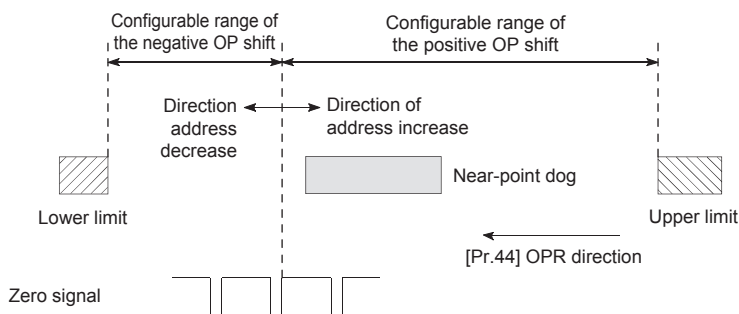

Movement speed during the OP shift

When the OP shift function is used, set the movement speed during the OP shift in [Pr.56] Speed specification during OP shift. Select the movement speed during the OP shift from [Pr.46] OPR speed or [Pr.47] Creep speed. Set the speed in [Pr.56] Speed specification during OP shift.

The following figures show the movement speed during the OP shift when the machine OPR is performed using the near-point dog method.

■OP shift operation at the speed set in [Pr.46] OPR speed (when [Pr.56] Speed specification during OP shift is 0)

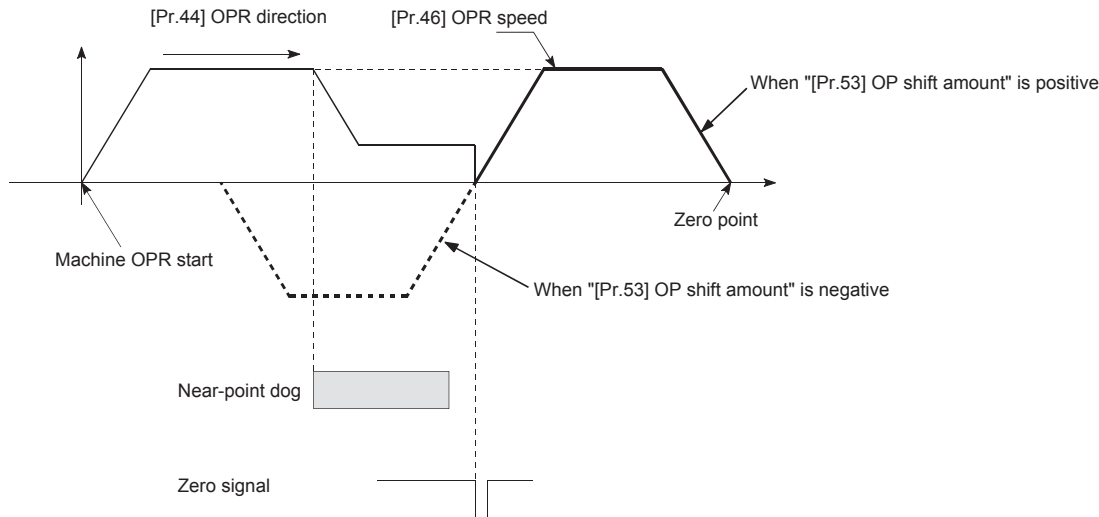

■OP shift operation at the speed set in [Pr.47] Creep speed (when [Pr.56] Speed specification during OP shift is 1)

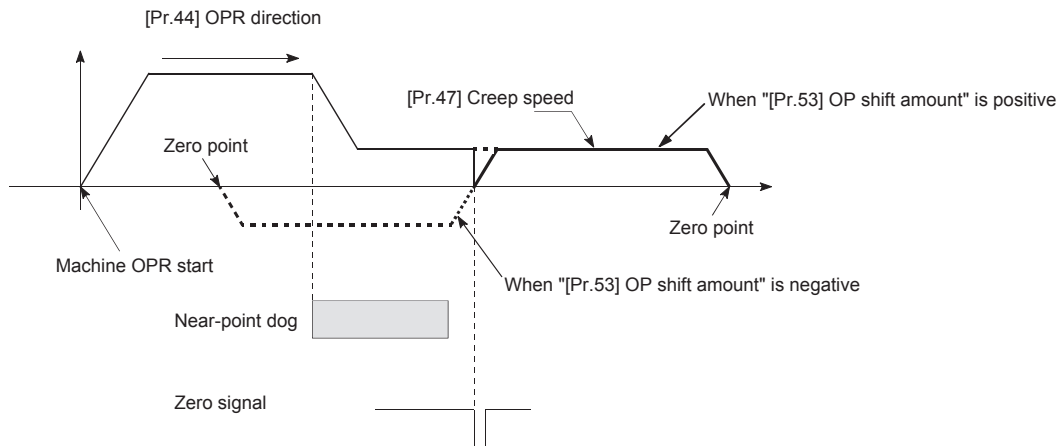

Control precautions

- OPR complete flag ([Md.31] Status: b4), [Md.20] Current feed value, [Md.21] Machine feed value, and [Md.26] Axis operation status are set after the OP shift operation is completed. OPR request flag ([Md.31] Status: b3) is reset after the OP shift operation is completed.
- The value set in [Pr.53] OP shift amount is not added in [Md.34] Movement amount after near-point dog ON. The movement amount immediately before the OP shift operation, considering the amount when the near-point dog is on as 0, is stored. For the stopper method (1, 2, 3), the movement amount is not changed from 0.
- When using the OP shift function with the stopper method (1, 2, 3) selected for the OPR method, configure the OP shift operation in the opposite direction of the OPR direction. Shifting in the OPR direction is not possible due to a mechanical stopper in the OPR direction.

Setting method

To use the OP shift function, configure the required settings in the parameters shown in the following table, and write them to the positioning module.

When the parameters are set, the OP shift function will be added to the machine OPR control. The settings are validated at the rising edge (when turned off and on) of [Cd.190] PLC READY signal.

Setting item		Setting value	Setting detail	Initial value at the factory	Buffer memory address	
					Axis 1	Axis 2
[Pr.53]	OP shift amount	→	Set the shift amount during the OP shift.	0	84 85	234 235
[Pr.56]	Speed specification during OP shift	→	Select the speed during the OP shift. • 0: [Pr.46] OPR speed • 1: [Pr.47] Creep speed	0	88	238

For details on the settings, refer to the following.

 Page 420 [Pr.53] OP shift amount

 Page 421 [Pr.56] Speed specification during OP shift

Point

- Parameters are set for each axis.
- Setting the parameters using GX Works3 is recommended. To perform the setting using programs, many programs and devices are required. The execution becomes complicated, and the scan times will increase.

12.3 Function to Compensate Control

The functions to compensate the control include Backlash compensation function, Electronic gear function, Near pass function, and Output timing selection of near pass control. Each function is executed by setting parameters or creating and writing a program.

Backlash compensation function

This function compensates the backlash amount in the machine system.

When the backlash compensation amount is set, pulses for an extra amount equivalent to the set backlash amount are output every time the movement direction changes.

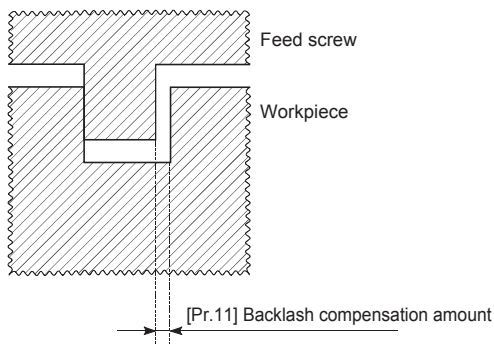

Control details

The following figure shows the operation of the backlash compensation function.

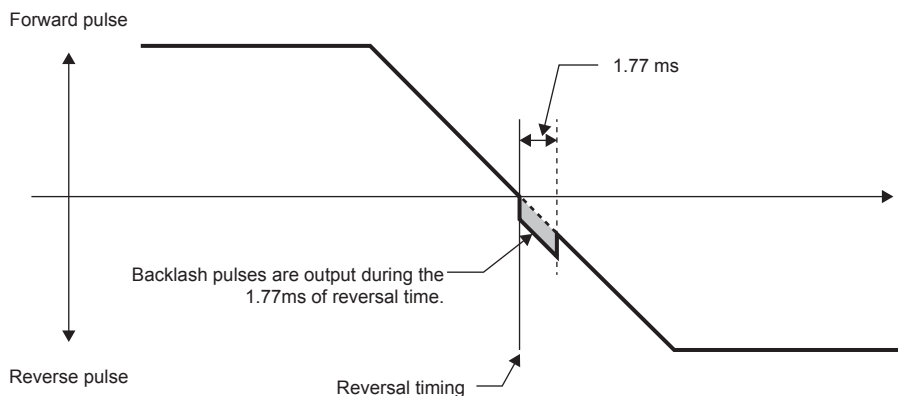

Control precautions

- The feed pulses of the backlash compensation amount are not added to [Md.20] Current feed value or [Md.21] Machine feed value.
- Always perform the machine OPR before starting the control when using the backlash compensation function (when [Pr.11] Backlash compensation amount is set). If the machine OPR is not performed, the backlash amount in the machine system cannot be correctly compensated.
- The number of pulses output in one backlash compensation (value determined by dividing the value in [Pr.11] Backlash compensation amount by Movement amount per pulse) must be 255 or smaller. If 256 or larger value is set, Backlash compensation amount error (Error code: 1AA0H) occurs. (Depending on the connected servo motor, tracking may not be possible if a large number of pulses are output at once.)

$$0 \leq \frac{\text{Backlash compensation amount}}{\text{Movement amount per pulse}} \leq 255 \text{ (Omit values after the decimal point)}$$

- The backlash compensation including the movement amount and [Pr.11] Backlash compensation amount is output when the moving direction changes.
- The backlash compensation function cannot be used for an axis where a stepping motor is connected. Set 0 (initial value) in [Pr.11] Backlash compensation amount.

Setting method

To use Backlash compensation function, set Backlash compensation amount in the parameters shown in the following table and write them to the positioning module.

The settings are validated at the rising edge (when turned off and on) of [Cd.190] PLC READY signal.

Setting item	Setting value	Setting detail	Initial value at the factory	Buffer memory address	
				Axis 1	Axis 2
[Pr.11]	Backlash compensation amount	→	Set the backlash compensation amount.	0	17

For details on the settings, refer to the following.

📖 Page 396 [Pr.11] Backlash compensation amount

Point

- Parameters are set for each axis.
- Setting the parameters using GX Works3 is recommended. To perform the setting using programs, many programs and devices are required. The execution becomes complicated, and the scan times will increase.

Electronic gear function

This function adjusts the pulses calculated and output according to the parameters set in the positioning module with the actual machine movement amount.

Electronic gear function is classified into the following four functions.

- The function converts the command value (speed, movement amount from the start point to the end point) set in mm units into pulse units and determines the pulse frequency and number of the command pulses.

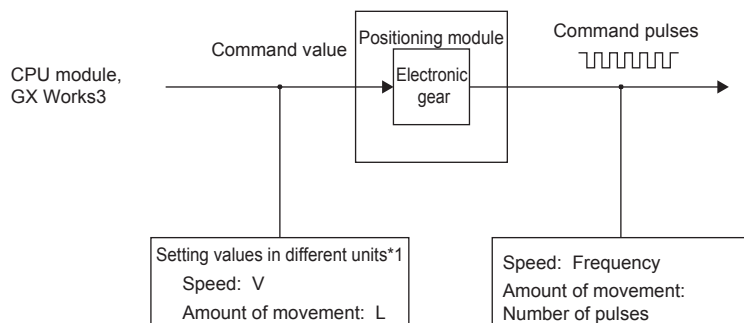

*1 Unit specified with [Pr.1] Unit setting (mm, inch, degree, or pulse)

- If values less than one pulse are generated by converting the movement amount from the start point to the end point in units of pulses, values less than one pulse are not output and the machine stops at the front side of the positioning direction. The values less than one pulse that are not output are accumulated in the positioning module. When the total cumulative value has reached one pulse or more, one pulse is output.
- When the machine OPR is completed, when the current value change is completed, when the speed control is started (excluding when the current feed value change is enabled), or when the fixed-feed control is started, the function clears the cumulative values less than one pulse which could not be output to 0. (If the cumulative value is cleared, an error will occur for the cleared amount in the machine feed value. Control can be constantly performed with the same machine movement amount even when the fixed-feed control is continued.)
- The function compensates the machine system error of the command movement amount and actual movement amount by adjusting Movement amount per pulse. (The value of Movement amount per pulse is defined using [Pr.2] No. of pulses per rotation, [Pr.3] Movement amount per rotation, and [Pr.4] Unit magnification.)
- The positioning module automatically performs the processing other than the error compensation.

Movement amount per pulse

[Pr.2] No. of pulses per rotation (A_p), [Pr.3] Movement amount per rotation (A_l), and [Pr.4] Unit magnification (A_m) are the items for determining how many rotations (equivalent to how many pulses) a motor should operate to move a machine for the movement amount set in the program.

The drive unit controls the positioning to a motor with the number of pulses.

The following shows the control details of the positioning module.

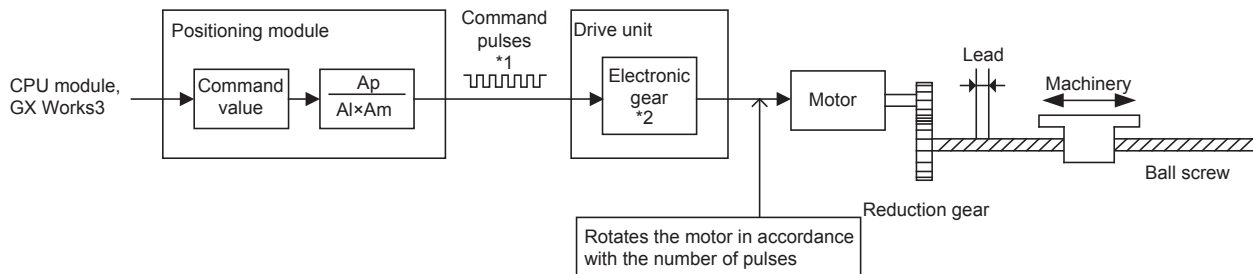

*1 For the FX5-20PG-P, the upper limit of the command pulse frequency is 200 kpulse/s, and for the FX5-20PG-D, the upper limit is 5 Mpulse/s.

*2 For a drive unit without the electronic gear function, or when the electronic gear function is not used, this value is 1.

Consider a system with a motor connected to a ball screw as shown in the figure above. The electronic gear of the drive unit is 1.

The movement amount of the machine is in units of mm or inches. Set the command value in units of mm or inches to the positioning module for the CPU module program.

The motor is controlled by the drive unit in units of pulses. Therefore, since the command value in units of mm or inches is converted in units of pulses, set A_p , A_l , and A_m so that the following relational expression is satisfied.

Item	Symbol
Number of pulses per rotation of motor	A_p
Movement amount per rotation of motor	$A_l \times A_m$

In this case, the machine movement amount for the command 1 pulse output from the positioning module is calculated by the following calculation formula.

$$\text{Movement per pulse (A)} = \frac{A_l \times A_m}{A_p}$$

Point

The command frequency from the positioning module is limited. If the command frequency exceeds the upper limit, increase Movement amount per pulse (A) greater (N times) to decrease the command frequency.

In this case, the electronic gear on the drive unit must be increased by N times as well.

The command pulse from the positioning module is changes to 1/N times. Therefore, multiply it by N on the drive unit side to keep the number of rotations of the motor.

Because Movement amount per pulse (A) is increased, the position accuracy (command resolution) for the command 1 pulse from the positioning module decreases.

Consider to decrease the command speed when the position accuracy is required.

■ Setting range of Ap, AI, and Am

The 16-bit mode and 32-bit mode are provided for each Ap, AI, and Am, and they can be switched by setting a value in [Pr.62] Electronic gear selection. When the resolution of the servo amplifier is high, values of Ap and AI can be set without reducing the values by using an electronic gear with 32 bits.

Determined setting ranges are available for Ap, AI, and Am. The following table shows the setting ranges.

Setting item		Setting range	Buffer memory address	
			Axis 1	Axis 2
[Pr.2]	No. of pulses per rotation (Ap)	When [Pr.62] Electronic gear selection is set to 0: 16 bits 1 to 65535	1	151
		When [Pr.62] Electronic gear selection is set to 1: 32 bits 1 to 200000000	102 103	252 253
[Pr.3]	Movement amount per rotation (AI)	When [Pr.62] Electronic gear selection is set to 0: 16 bits 1 to 65535	2	152
		When [Pr.62] Electronic gear selection is set to 1: 32 bits 1 to 200000000		
[Pr.4]	Unit magnification (Am)	When [Pr.62] Electronic gear selection is set to 0: 16 bits 1, 10, 100, 1000 time(s)	3	153
		When [Pr.62] Electronic gear selection is set to 1: 32 bits 1 time		

For details on the settings, refer to the following.

- ☞ Page 385 [Pr.1] Unit setting
- ☞ Page 386 [Pr.2] No. of pulses per rotation (16 bits) (Ap)
- ☞ Page 387 [Pr.3] Movement amount per rotation (16 bits) (AI)
- ☞ Page 392 [Pr.2] No. of pulses per rotation (32 bits) (Ap)
- ☞ Page 393 [Pr.3] Movement amount per rotation (32 bits) (AI)

In addition, use the value set in [Pr.3] Movement amount per rotation as the movement amount per rotation (AI) to calculate the movement amount per pulse (A).

Ex.

Movement amount per pulse (A) when [Pr.1] Unit setting is 0: mm

Setting item	Setting value
[Pr.2] No. of pulses per rotation	20000
[Pr.3] Movement amount per rotation	40000
[Pr.4] Unit magnification	1

$$A = 40000 \times 10^{-1} \times 1 \div 20000 = 0.2 \mu\text{m}$$

If the value is beyond the setting range, setting values of each parameter can be decreased by reducing the numerator and denominator with the movement amount per pulse (A) kept.

Error compensation method

When the position control is performed using the movement amount per pulse set in the positioning module parameters, an error sometimes occurs between the command movement amount (L) and actual movement amount (L').

That error is compensated in the positioning module by adjusting the values in [Pr.2] No. of pulses per rotation, [Pr.3] Movement amount per rotation, and [Pr.4] Unit magnification. (When [Pr.1] Unit setting is 0: mm)

■Definition

Error compensation amount used to perform the error compensation is defined as follows.

$$\text{Error compensation amount} = \frac{\text{Actual movement (L')}}{\text{Command movement amount (L)}}$$

In the positioning module, Movement amount per pulse is calculated with the following calculation formula. Movement amount per pulse is (A), [Pr.2] No. of pulses per rotation is (Ap), [Pr.3] Movement amount per rotation is (Al), and [Pr.4] Unit magnification is (Am).

$$A = \frac{Al}{Ap} \times Am$$

■Procedure

1. Set Command movement amount (L) and perform the positioning. Set Movement amount per pulse (A) in advance. (☞ Page 229 Movement amount per pulse)
2. After the positioning is completed, measure Actual movement amount (L').
3. Calculate Error compensation amount.

$$\text{Error compensation amount} = \frac{L'}{L}$$

4. Calculate the post-compensation [Pr.2] No. of pulses per rotation (Ap'), [Pr.3] Movement amount per rotation (Al'), and [Pr.4] Unit magnification (Am') from Post-compensation movement amount per pulse (A'). (Adjust the values with Am' so that Al' and Ap' do not exceed the setting range.)

$$\begin{aligned} A' &= A \times \text{Error compensation amount} \\ &= \frac{Al}{Ap} \times Am \times \frac{L'}{L} \\ &= \frac{Al'}{Ap'} \times Am' \end{aligned}$$

[Calculation example]

Condition	<ul style="list-style-type: none"> • Movement amount per rotation: 5000 (μm/rev) • No. of pulses per rotation: 12000 (pulse/rev) • Unit magnification: 1
Positioning result	<ul style="list-style-type: none"> • Command movement amount: 100 mm • Actual movement amount: 101 mm
Correction value	$\frac{AL'}{AP'} = \frac{5 \times 10^3}{12000} \times \frac{101 \times 10^3}{100 \times 10^3} = \frac{5050}{12000} = \frac{101}{240}$ <ul style="list-style-type: none"> • Movement amount per rotation: 101 (μm/rev) ([Pr.3] setting) • No. of pulses per rotation: 240 (pulse/rev) ([Pr.2] setting) • Unit magnification: 1 ([Pr.4] setting)

5. Set the post-compensation [Pr.2] No. of pulses per rotation (Ap'), [Pr.3] Movement amount per rotation (Al'), and [Pr.4] Unit magnification (Am') in the parameters, and write them to the positioning module. The settings are validated at the rising edge (when turned off and on) of [Cd.190] PLC READY signal.

Setting item		Setting value	Setting detail	Value before compensation
[Pr.2]	No. of pulses per rotation	Ap'	Set the post-compensation value.	Ap
[Pr.3]	Movement amount per rotation	Al'	Set the post-compensation value.	Al
[Pr.4]	Unit magnification	Am'	Set the post-compensation value.	Am

For details on the settings, refer to the following.

- ☞ Page 385 [Pr.1] Unit setting
- ☞ Page 386 [Pr.2] No. of pulses per rotation (16 bits) (Ap)
- ☞ Page 387 [Pr.3] Movement amount per rotation (16 bits) (Al)
- ☞ Page 392 [Pr.2] No. of pulses per rotation (32 bits) (Ap)
- ☞ Page 393 [Pr.3] Movement amount per rotation (32 bits) (Al)

Control precautions

If values less than one pulse are generated by converting the movement amount from the start point to the end point into units of pulses with the electronic gear function, values less than one pulse are not output and the machine stops at the front side of the positioning direction.

The values less than one pulse that are not output are accumulated in the positioning module. When the total cumulative value has reached one pulse or more, one pulse is output.

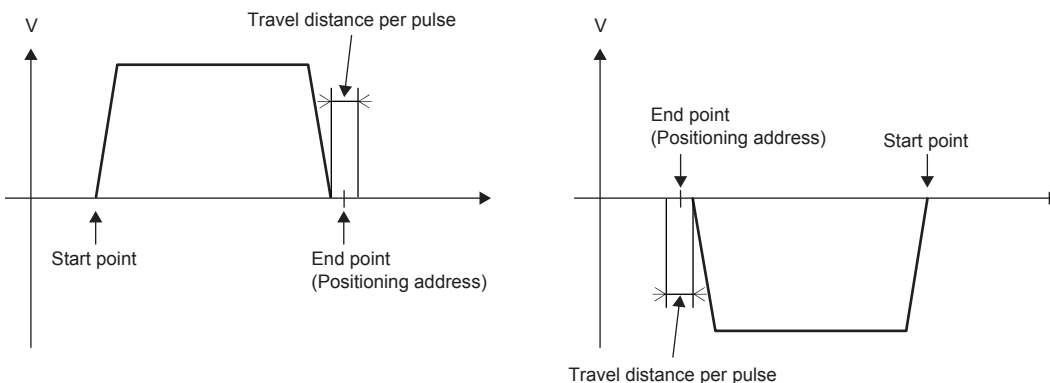

To prevent values less than one pulse from being generated, set the positioning address so that the value calculated by multiplying the movement amount to the end point by the inverse number of Movement amount per pulse (A) becomes an integer.

Setting a value close to 1 for Movement amount per pulse (A) is recommended for the following reasons. Movement amount per pulse of 1 means the minimum value in each [Pr.1] Unit setting (0.1 [μm] for the unit [mm]).

- Note that if the setting value of the movement amount per pulse is decreased, the command frequency increases. Be aware of this when changing settings.
- If the setting value of the movement amount per pulse is less than 1, the machine system may oscillate. Always use the movement amount per pulse within the following range. If the machine system oscillates, use the electronic gear function of the drive unit and increase the movement amount per pulse.

$$\text{Movement amount per pulse (A)} \geq \frac{1}{500}$$

- Set the movement amount per pulse so that the pulse output frequency for the drive unit becomes a value in the following table.

	FX5-20PG-P	FX5-20PG-D
Pulse output frequency for drive unit	200 kpulse/s or less	5 Mpulse/s or less

If the setting value of the pulse output frequency for the drive unit exceeds a value in the table above, the positioning module may not operate properly.

In the positioning module, the generic term for the functions in this section is defined as Electronic gear function. For the definition of Electronic gear on the servomotor side, refer to the manual for the servomotor used.

Near pass function

When the continuous path control is performed using the interpolation control, the near pass function is performed.

This function suppresses the machine vibration occurring at the time of switching the positioning data when the continuous path control is performed using the interpolation control.

[Near pass function]

The extra movement amount occurring at the end of each positioning data being continuously executed is carried over to the next positioning data. Since the alignment is not performed, the output speed drops are eliminated and the machine vibration which occurs during the speed change can be suppressed.

Since the alignment is not performed, the operation is controlled in a path that passes near the position set in [Da.6] Positioning address/movement amount.

Control details

The following figure shows the path of the continuous path control using the 2-axis linear interpolation control.

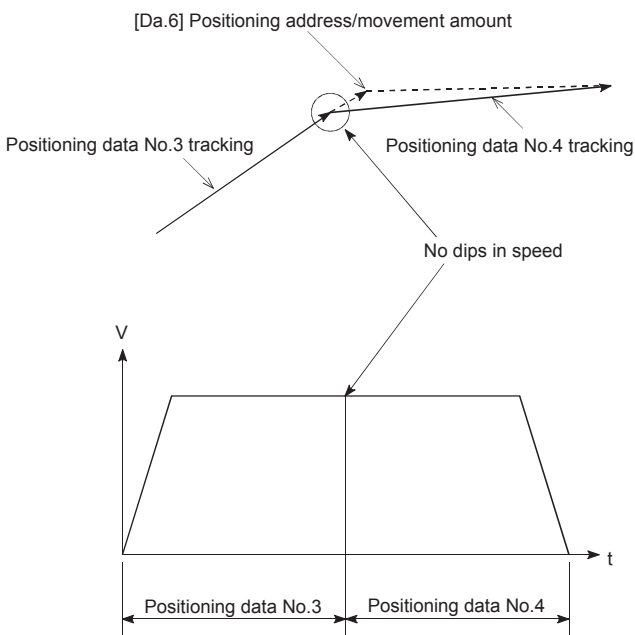

Control precautions

- If the movement amount specified by the positioning data is small during the execution of the continuous path control, the output speed may not reach the command speed.
- The movement direction is not checked during the interpolation control. Thus, the deceleration stop is not performed even if the movement direction is changed. (Refer to the following figure.) Therefore, the interpolation axis may suddenly reverse its direction. To avoid the sudden direction reversal, set Continuous positioning control: 01 for the positioning data at the passing point instead of Continuous path control: 11.

■ Positioning by interpolation

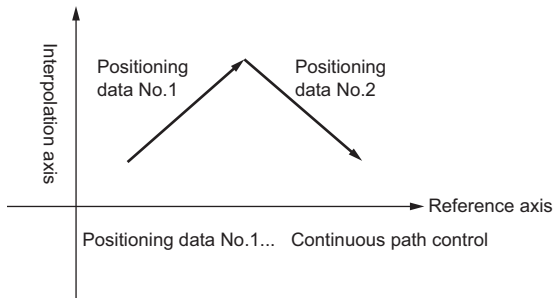

■ Reference axis operation

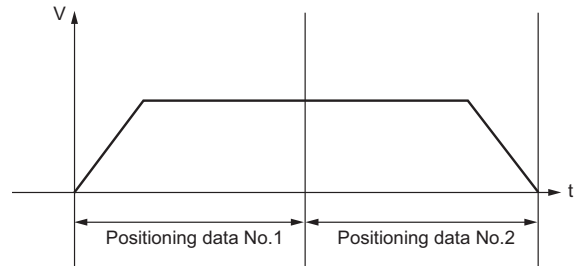

■ Partner axis operation

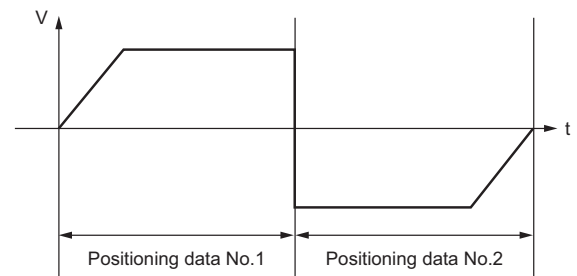

Output timing selection of near pass control

This function allows the user to select the timing to output the difference (Δd) between the actual and the set positioning end addresses in the continuous path control, in which the difference (d) is output during the execution of the next positioning data.

Control details

At constant speed and At deceleration are available as the setting of the near pass output timing.

- At constant speed: The distance Δd is output when the next positioning data is executed at the constant speed.
- At deceleration: The distance Δd is output at the deceleration of $V1$ to $V2$.

In At constant speed, when $V1$, the command speed of the positioning data No. 1, is greater than $V2$, the command speed of the positioning data No. 2, in the operation chart, the distance Δd is output when the next positioning data is executed at the constant speed and the execution time is extended.

In At deceleration, the execution time is not extended and is equivalent to the set execution time of the positioning control.

The following shows the operation chart of Output timing selection of near pass control.

- Theoretical acceleration/deceleration per the design

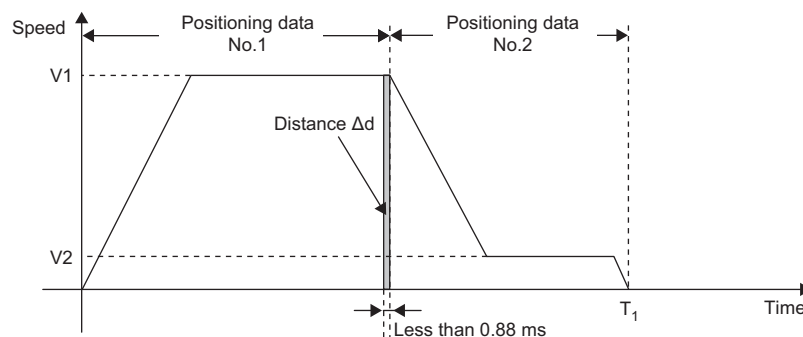

- Actual acceleration/deceleration via the near-pass function

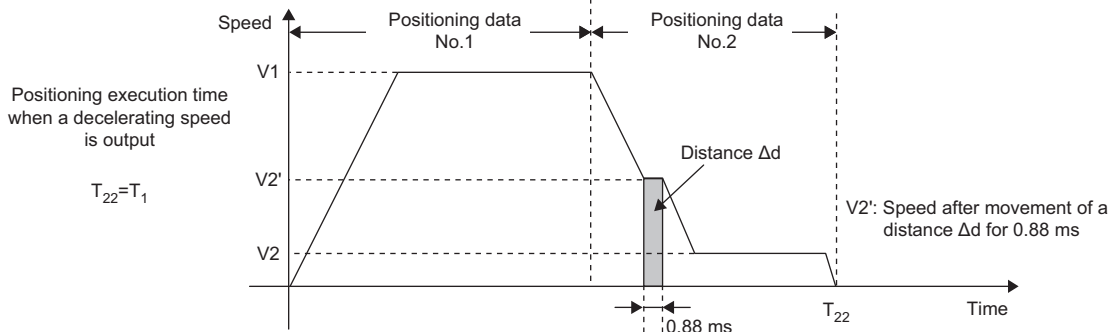
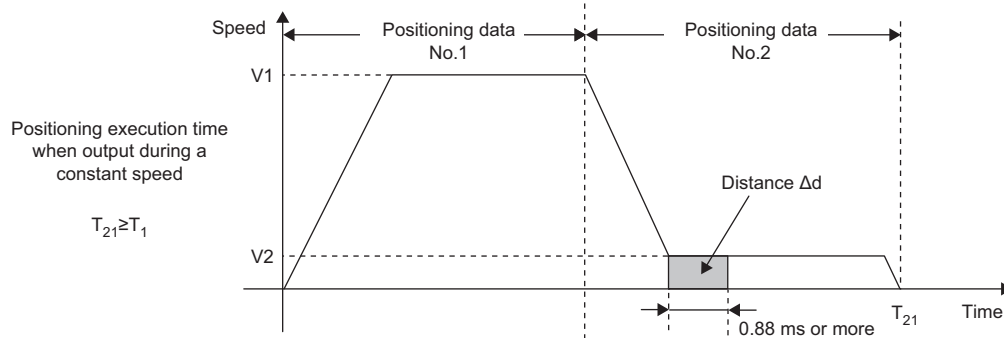

Control precautions

When the relation of command speed V1 and V2 is one of the following, the same command output as the one for At constant speed is executed even if the near pass output timing is set to At deceleration.

- When $V1 \leq V2$

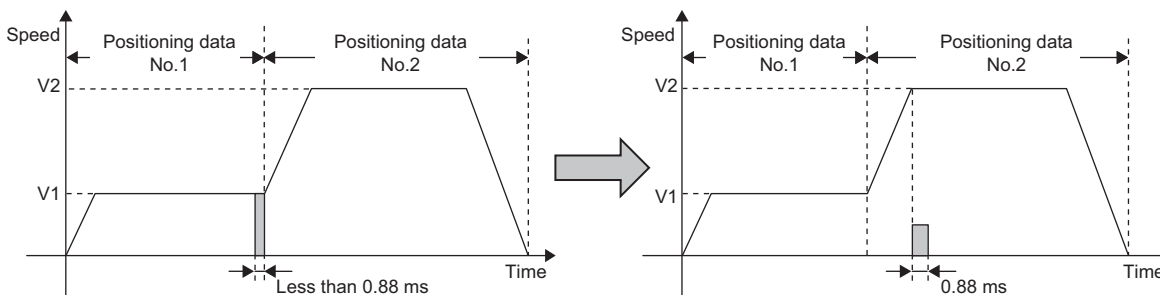

- When (the value that the distance Δd is converted into the speed) $\leq V2 < V1$

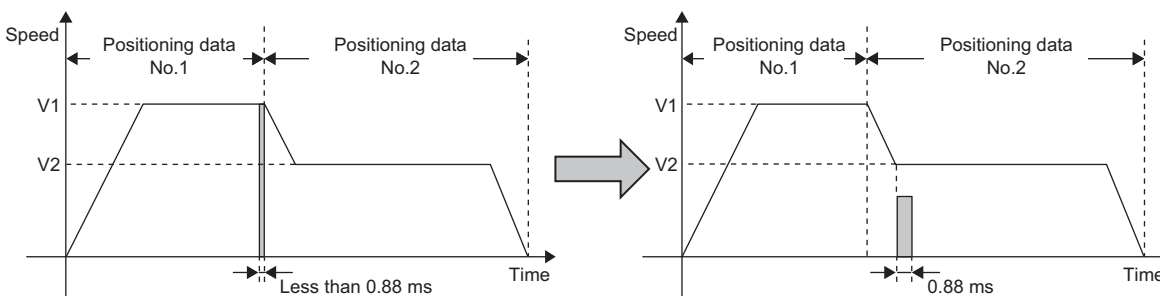

The height of the shaded area in the right figure shows the value that the distance Δd is converted into the speed.

Setting method

To use Output timing selection of near pass control, set the setting value to the following control data with the program. The settings are validated at the rising edge (when turned off and on) of [Cd.190] PLC READY signal.

Setting item	Setting value	Setting detail	Initial value at the factory	Buffer memory address	
				Axis 1	Axis 2
[Cd.43] Output timing selection of near pass control	→	The user selects the timing to output the difference (Δd) between the actual and the set positioning end addresses in the continuous path control, in which the difference (d) is output during the execution of the next positioning data. <ul style="list-style-type: none"> • 0: At a constant speed • 1: During deceleration 	0	1934	

For details on the settings, refer to the following.

☞ Page 468 [Cd.43] Output timing selection of near pass control

12.4 Function to Limit Control

Functions to limit the control include Speed limit function, Torque limit function, Software stroke limit function, and Hardware stroke limit function. Each function is executed by setting parameters or creating and writing a program.

Speed limit function

Speed limit function limits the command speed to a value within the setting range of Speed limit value when the command speed during the control exceeds Speed limit value.

When the command speed exceeds the value set in [Pr.8] Speed limit value, [Md.39] In speed limit flag turns on and Outside command speed range (Warning code: 0A10H) occurs.

Relation between the speed limit function and various controls

The following table shows the relation between Speed limit function and various controls.

⊙: Always set
 —: Setting not required (The set value is ignored. Set the value within the setting range, such as the initial value.)

Control type		Speed limit function	Speed limit value
OPR control	Machine OPR control	⊙	[Pr.8] Speed limit value
	Fast OPR control	⊙	
Major positioning control	Position control	1-axis linear control	⊙
		2-axis linear interpolation control	⊙
		1-axis fixed-feed control	⊙
		2-axis fixed-feed control	⊙
		2-axis circular interpolation control	⊙
	1/2-axis speed control	⊙	
	Speed-position switching control, Position-speed switching control	⊙	
	Other controls	Current value change	—
JUMP instruction, NOP instruction LOOP to LEND		—	
Manual control	JOG operation, Inching operation	⊙	[Pr.31] JOG speed limit value
	Manual pulse generator operation	—	Setting value is invalid

Control precautions

- If any axis exceeds the value in [Pr.8] Speed limit value during either of the 2-axis speed control, the axis exceeding the speed limit value is controlled with the speed limit value. The speeds of the other axes being interpolated are suppressed by the command speed ratio.
- If any axis exceeds the value in [Pr.8] Speed limit value during any of the 2-axis linear interpolation control, 2-axis fixed-feed control, 2-axis circular interpolation control, the axis exceeding the speed limit value is controlled with the speed limit value. The speeds of the other axes being interpolated are suppressed by the movement amount ratio.
- In the 2-axis linear interpolation control or 2-axis fixed-feed control, when 1: Reference axis speed is set in [Pr.20] Interpolation speed specification method, and when the reference axis is the minor axis and the interpolation axis is the major axis, the speed limit value of the interpolation axis may not function.

Setting method

To use the speed limit function, configure the required settings in the parameters shown in the following table, and write them to the positioning module. The set data is validated when the data is written into the positioning module.

Setting item		Setting value	Setting detail	Initial value at the factory	Buffer memory address	
					Axis 1	Axis 2
[Pr.8]	Speed limit value	→	Set the speed limit value (maximum speed during the control).	200000	10 11	160 161
[Pr.31]	JOG speed limit value	→	Set the speed limit value during the JOG operation (maximum speed during the control). (Note that the value in [Pr.31] JOG speed limit value ≤ shall be equal to or less than the one in [Pr.8] Speed limit value.)	20000	48 49	198 199

For details on the settings, refer to the following.

 Page 394 [Pr.8] Speed limit value

 Page 405 [Pr.31] JOG speed limit value

Point

- Parameters are set for each axis.
- Setting the parameters using GX Works3 is recommended. To perform the setting using programs, many programs and devices are required. The execution becomes complicated, and the scan times will increase.

Torque limit function

If the torque generated in the servo motor exceeds Torque limit value, this function limits the generated torque to a value within the setting range of Torque limit value.

This function protects the reducer and limits the power of the pressing operation against the stopper. This function controls the operation so that an excessive load or excessive force is not applied to the machine.

The positioning module does not perform the torque limit of the servo motor directly using this function. The torque limit command to the servo amplifier is performed by the D/A converter module.

System configuration for performing the torque limit

Perform the torque limit in the following configuration. (The following modules are required.)

- D/A converter module
- Drive unit capable of performing the torque limit control with the analog voltage input

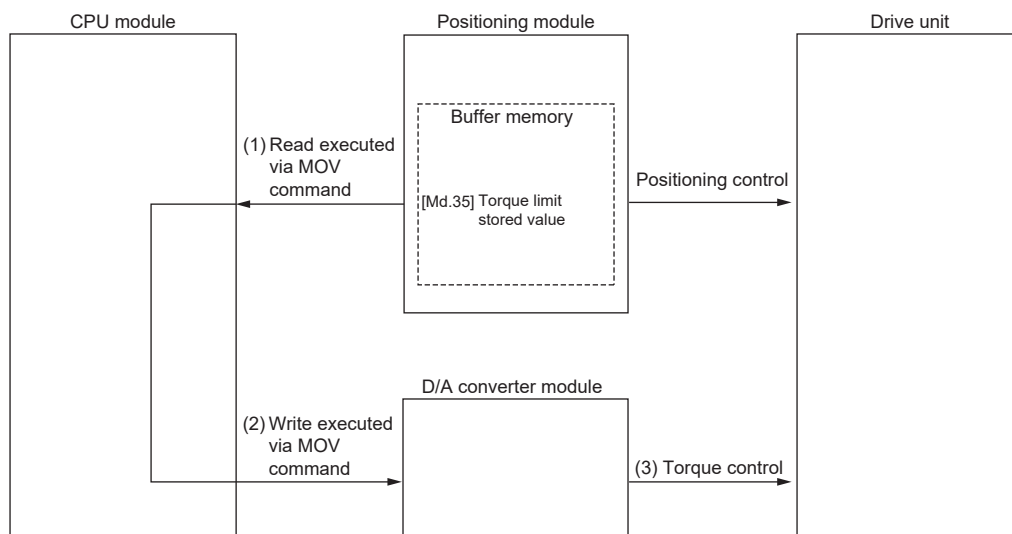

(1) Read the value in [Md.35] Torque limit stored value.

(2) Write the read value into the D/A converter module. (The value must be converted according to the specifications of the D/A converter module.)

(3) The drive unit performs the torque limit according to the voltage input value from the D/A converter module.

Point

The positioning module monitors the creep speed reach during the OPR control and updates the value in [Md.35] Torque limit stored value to the one in [Pr.54] OPR torque limit value. Monitoring this value prevents the need to monitor the creep speed reach using the program. If all controls of the torque limit value are performed using the program ((1) Read with the MOV instruction in the figure), this function does not have to be used.

Relation between the torque limit function and various controls

The following table shows the relation between Torque limit function and various controls.

○: Set as required

—: Setting not required (The set value is ignored. Set the value within the setting range, such as the initial value.)

Control type		Torque limit function	Torque limit value ^{*1}
OPR control	Machine OPR control	○	[Pr.17] Torque limit setting value After the reach of [Pr.47] Creep speed, this value becomes the value in [Pr.54] OPR torque limit value.
	Fast OPR control		
Major positioning control	Position control	1-axis linear control	[Pr.17] Torque limit setting value
		2-axis linear interpolation control	
		1-axis fixed-feed control	
		2-axis fixed-feed control	
		2-axis circular interpolation control	
		1/2-axis speed control	
	Speed-position switching control, Position-speed switching control	○	
	Other controls	Current value change	—
JUMP instruction, NOP instruction LOOP to LEND	—		
Manual control	JOG operation, Inching operation	○	[Pr.17] Torque limit setting value
	Manual pulse generator operation	○	[Pr.17] Torque limit setting value

*1 The torque limit value when [Cd.22] New torque value is set to 0.

Control details

The following shows the operation of the torque limit function.

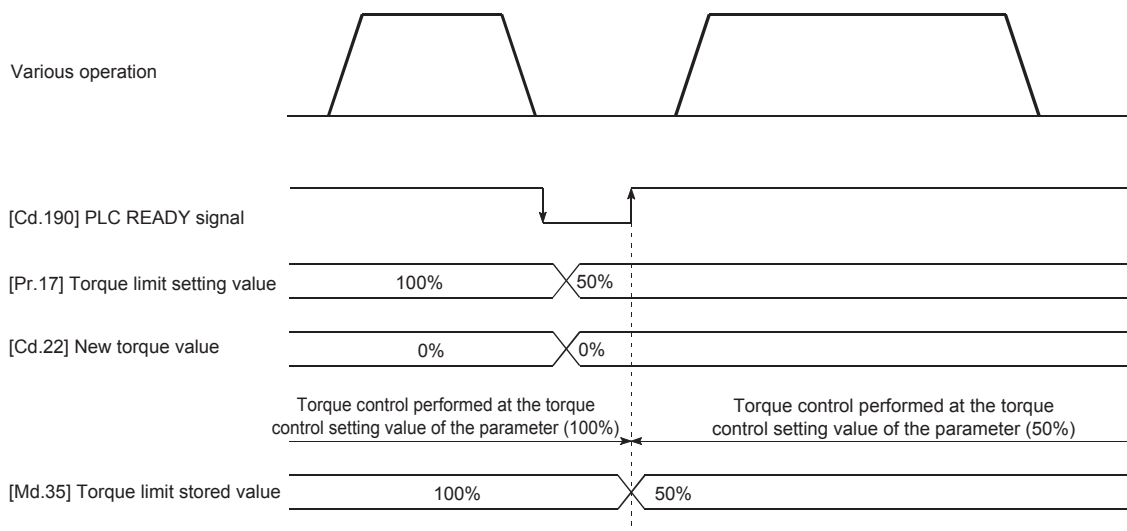

Control precautions

- To limit the torque with the value set in [Pr.17] Torque limit setting value, check that [Cd.22] New torque value is set to 0. If a value other than 0 is set for [Cd.22] New torque value, the value is validated and used for the torque limit. ( Page 239 Torque limit function)
- When the value set in [Pr.54] OPR torque limit value exceeds the value set in [Pr.17] Torque limit setting value, OPR torque limit value error (Error code: 1B0EH) occurs.
- When the operation is stopped by the torque limit, a droop pulse remains in the deviation counter. If Deviation counter clear is performed by issuing an external signal at this time, the position will be deviated when the operation is continued. If the load torque is eliminated, the operation for the amount of droop pulses is performed.

Setting method

To use the torque limit function, configure the required settings in the parameters shown in the following table, and write them to the positioning module. The settings are validated at the rising edge (when turned off and on) of [Cd.190] PLC READY signal.

Setting item		Setting value	Setting detail	Initial value at the factory	Buffer memory address	
					Axis 1	Axis 2
[Pr.17]	Torque limit setting value	→	Set the torque limit value in percentage.	300	26	176
[Pr.54]	OPR torque limit value	→	Set the torque limit value after the reach of [Pr.47] Creep speed in percentage.	300	86	236

For details on the settings, refer to the following.

 Page 399 [Pr.17] Torque limit setting value

 Page 421 [Pr.54] OPR torque limit value

The following table shows the buffer memory address of [Md.35] Torque limit stored value.

Monitor item		Monitor value	Stored contents	Buffer memory address	
				Axis 1	Axis 2
[Md.35]	Torque limit stored value	→	Torque limit value which is valid at that time is stored. ([Pr.17] Torque limit setting value, [Pr.54] OPR torque limit value, or [Cd.22] New torque value)	826	926

For details on the stored contents, refer to the following.

 Page 462 [Md.35] Torque limit stored value

Point

- Parameters are set for each axis.
- Setting the parameters using GX Works3 is recommended. To perform the setting using programs, many programs and devices are required. The execution becomes complicated, and the scan times will increase.

Software stroke limit function

In this function, the address established by the machine OPR is used to set the upper/lower limits of the movable range of the workpiece. If a movement command is issued to an address outside the set range, the command is not performed. In the positioning module, Current feed value and Machine feed value are used as the addresses indicating the current value. Select one of the addresses used for the limit check and set a value in [Pr.14] Software stroke limit selection.

For details on Current feed value and Machine feed value, refer to the following.

☞ Page 112 Checking the current value

The upper and lower limits of the movable range of the workpiece are set in [Pr.12] Software stroke limit upper limit value or [Pr.13] Software stroke limit lower limit value.

Differences in the movable range

The following figure shows the movable range of the workpiece when the software stroke limit function is used.

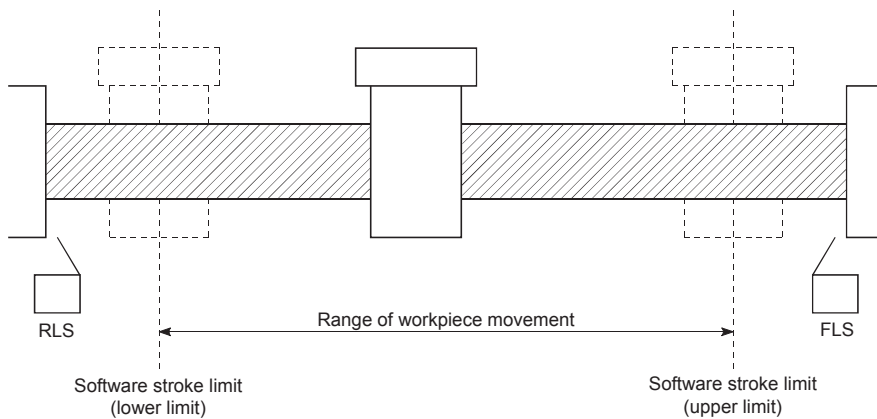

The following figures show the differences in the operation when [Md.20] Current feed value and [Md.21] Machine feed value are used for the movable range limit check.

■Condition

Assume that the current stop position is 2000 and the upper stroke limit is set to 5000.

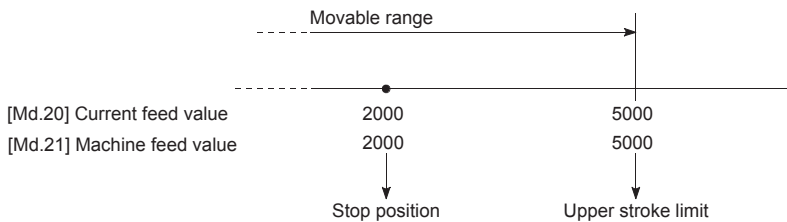

■ Current value change

When the current value is changed from 2000 to 1000, the current feed value changes to 1000, but the machine feed value remains 2000.

- When the machine feed value is set as a limit, the machine feed value of 5000 (current feed value: 4000) becomes the upper stroke limit.

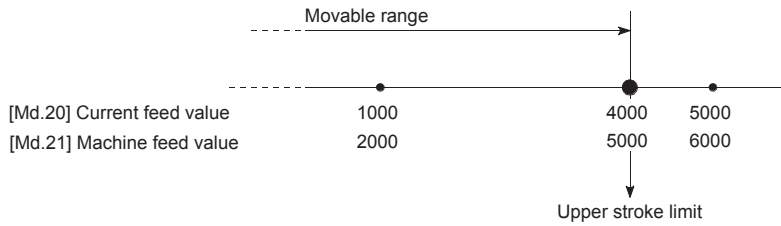

- When the current feed value is set as a limit, the current feed value of 5000 (machine feed value: 6000) becomes the upper stroke limit.

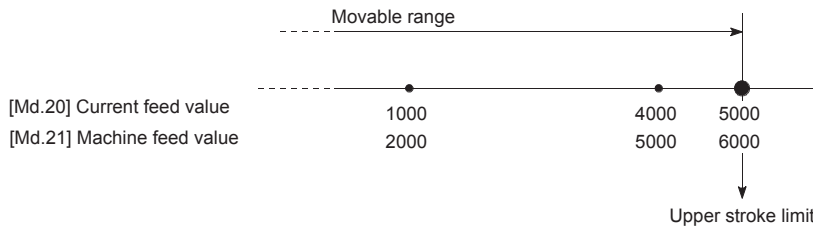

Point

When Machine feed value is set in [Pr.14] Software stroke limit selection, the movable range becomes an absolute range based on the OP. When Current feed value is set, the movable range becomes a relative range from Current feed value.

Details of the software stroke limit check

Check detail		Processing when an error occurs
(1)	An error occurs if the current value ^{*1} is outside the software stroke limit range ^{*2} . (Check [Md.20] Current feed value or [Md.21] Machine feed value.)	Software stroke limit (+) (Error code: 1993H) or Software stroke limit (-) (Error code: 1995H) occurs.
(2)	An error occurs if the command address is outside the software stroke limit range. (Check [Da.6] Positioning address/movement amount.)	Software stroke limit (+) (Error code: 1A18H) or Software stroke limit (-) (Error code: 1A1AH) occurs.

*1 Select either [Md.20] Current feed value or [Md.21] Machine feed value in [Pr.14] Software stroke limit selection.

*2 Movable range from [Pr.12] Software stroke limit upper limit value to [Pr.13] Software stroke limit lower limit value

Relation between the software stroke limit function and various controls

◎: Check valid

○: Check is not performed when the current feed value is not updated at the setting of Current feed value in "[Pr.14] Software stroke limit selection" during the speed control. (☞ Page 401 [Pr.21] Current feed value during speed control)

—: Check is not performed (check invalid)

△: Valid only when "0: Valid" is set in [Pr.15] Software stroke limit valid/invalid setting.

Control type		Limit check	Processing at check	
OPR control	Machine OPR control	—	Check is not performed.	
	Fast OPR control	—		
Major positioning control	Position control	1-axis linear control	◎	(1) and (2) in the following section are checked. ☞ Page 243 Details of the software stroke limit check ■ For speed control The machine decelerates and stops when the software stroke limit range is exceeded. ■ For position control The operation is not performed if the target address is outside the software stroke limit range.
		2-axis linear interpolation control	◎	
		1-axis fixed-feed control	◎	
		2-axis fixed-feed control	◎	
		2-axis circular interpolation control	◎	
	1/2-axis speed control	○ ^{*1,2}		
	Speed-position switching control, Position-speed switching control	○ ^{*1,2}		
Other controls	Current value change	◎	The current value change is not performed if the new current value is outside the software stroke limit range.	
	JUMP instruction, NOP instruction, LOOP to LEND	—	Check is not performed.	
Manual control	JOG operation, Inching operation	△ ^{*3}	(1) and (2) in the following section are checked. ☞ Page 243 Details of the software stroke limit check The machine decelerates and stops when the software stroke limit range is exceeded. The operation can be started only toward the direction of the movable range if the target address is outside the software stroke limit range.	
	Manual pulse generator operation	△ ^{*3}		

*1 The value in [Md.20] Current feed value differs depending on the setting of [Pr.21] Current feed value during speed control.

*2 When the unit is degree, the limit check is not performed during the speed control.

*3 When the unit is degree, the limit check is not performed.

Precautions for the software stroke limit check

- To execute Software stroke limit function properly, the machine OPR must be performed beforehand.
- During the interpolation control, the stroke limit check is performed for every current value of both the reference axis and interpolation axes. All the axes do not start if an error occurs even if an error occurs only in one axis.
- During the circular interpolation control, [Pr.12] Software stroke limit upper limit value or [Pr.13] Software stroke limit lower limit value may be exceeded. In this case, the machine does not decelerate and stop even if the stroke limit is exceeded. Always install limit switches externally if the stroke limit may be potentially exceeded.

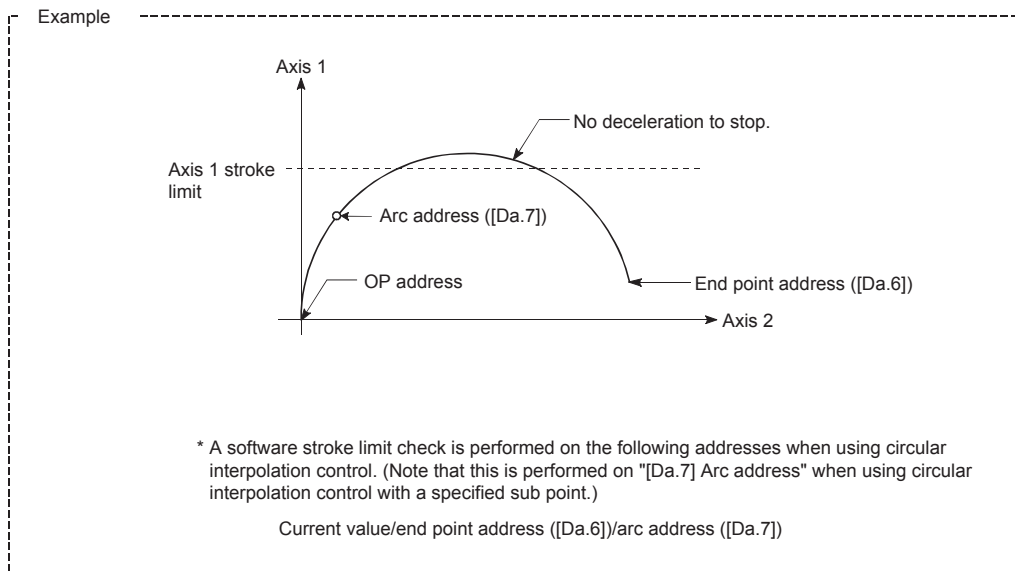

- If an error is detected during the continuous path control, the operation stops at the completion of the execution of the positioning data right before the positioning data having the error.

[Example]

Operation stops immediately after the execution of positioning data No.12 if the positioning address in positioning data No.13 is outside the range of the software stroke limit.

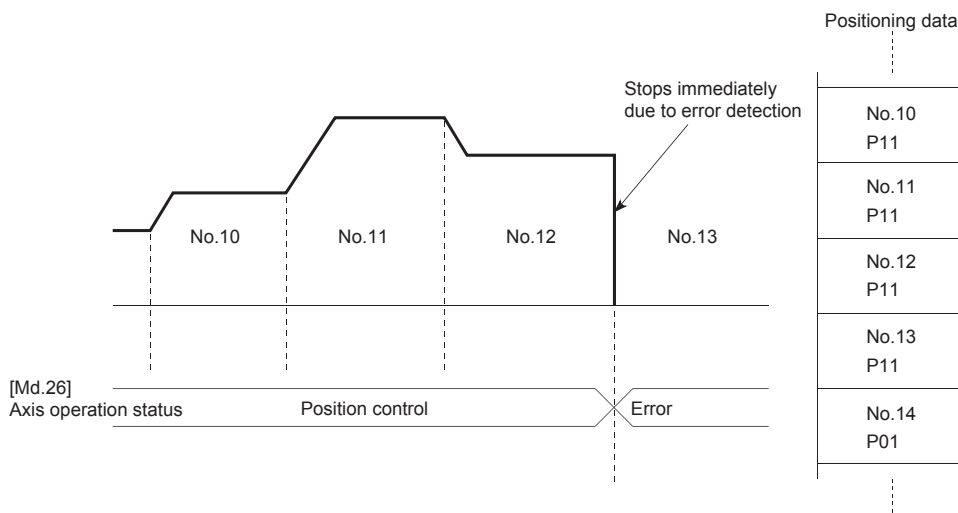

- When the simultaneous start is performed, the stroke limit check is performed for every current value of the axes to be started simultaneously. All the axes do not start if an error occurs even if an error occurs only in one axis.

Setting method

To use the software stroke limit function, set the required values in the parameters shown in the following table, and write them to the positioning module.

The settings are validated at the rising edge (when turned off and on) of [Cd.190] PLC READY signal.

Setting item		Setting value	Setting detail	Initial value at the factory	Buffer memory address	
					Axis 1	Axis 2
[Pr.12]	Software stroke limit upper limit value	→	Set the upper limit value of the movement range.	2147483647	18 19	168 169
[Pr.13]	Software stroke limit lower limit value	→	Set the lower limit value of the movement range.	-2147483648	20 21	170 171
[Pr.14]	Software stroke limit selection	→	Set whether to use [Md.20] Current feed value or [Md.21] Machine feed value as Current value.	0: Current feed value	22	172
[Pr.15]	Software stroke limit valid/invalid setting	0: Valid	Set whether to validate the software stroke limit during the manual control (JOG operation, inching operation, and manual pulse generator operation).	0: Valid	23	173

For details on the settings, refer to the following.

 Page 398 [Pr.15] Software stroke limit valid/invalid setting

Invalidating the software stroke limit

To invalidate the software stroke limit, set a single value in both [Pr.12] Software stroke limit upper limit value and [Pr.13] Software stroke limit lower limit value and write them to the positioning module. (Set a value within the setting range.) (To invalidate only the manual operation, set "1: Software stroke limit invalid" in [Pr.15] Software stroke limit valid/invalid setting.)

The settings are validated at the rising edge (when turned off and on) of [Cd.190] PLC READY signal.

When the unit is degree, the software stroke limit check is not performed during the speed control (including the speed-position switching control and position-speed switching control) or during the manual control regardless of the values set in [Pr.12], [Pr.13], and [Pr.15].

Point

- Parameters are set for each axis.
- Setting the parameters using GX Works3 is recommended. To perform the setting using programs, many programs and devices are required. The execution becomes complicated, and the scan times will increase.

Setting when the control unit is degree

Current value address

The address of [Md.20] Current feed value is a ring address from 0 to 359.99999°.

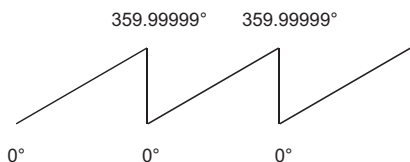

Setting the software stroke limit

The upper/lower limit values of the software stroke limit are between 0 and 359.99999°.

To validate the software stroke limit, set the upper limit value in the clockwise direction from the lower limit value.

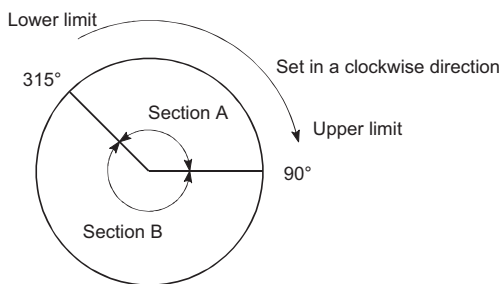

To set the section A or B as the movement range, set the following values.

Section set as the movement range	Software stroke limit lower limit value	Software stroke limit upper limit value
Section A	315.00000°	90.00000°
Section B	90.00000°	315.00000°

Hardware stroke limit function

In Hardware stroke limit function, limit switches are set at the upper/lower limits of the physical movement range, and the control is stopped (by deceleration stop) by the input of a signal from the limit switch.

This function prevents the machine from being damaged by stopping the operation before the workpiece reaches the upper or lower limit of the physical movement range.

Hardware stroke limit switches are normally installed inside the stroke limit or stroke end on the drive unit side, and the control is stopped before the stroke limit or stroke end on the drive unit side is reached.

Precautions

When the hardware stroke limit is required to be wired, ensure to wire it in the negative logic using a normally closed contact. If it is set in the positive logic using a normally open contact, the operation cannot be stopped and a collision occurs when a failure such as a disconnection occurs, resulting in the damage of the machine.

Control details

The following figure shows the operation of the hardware stroke limit function.

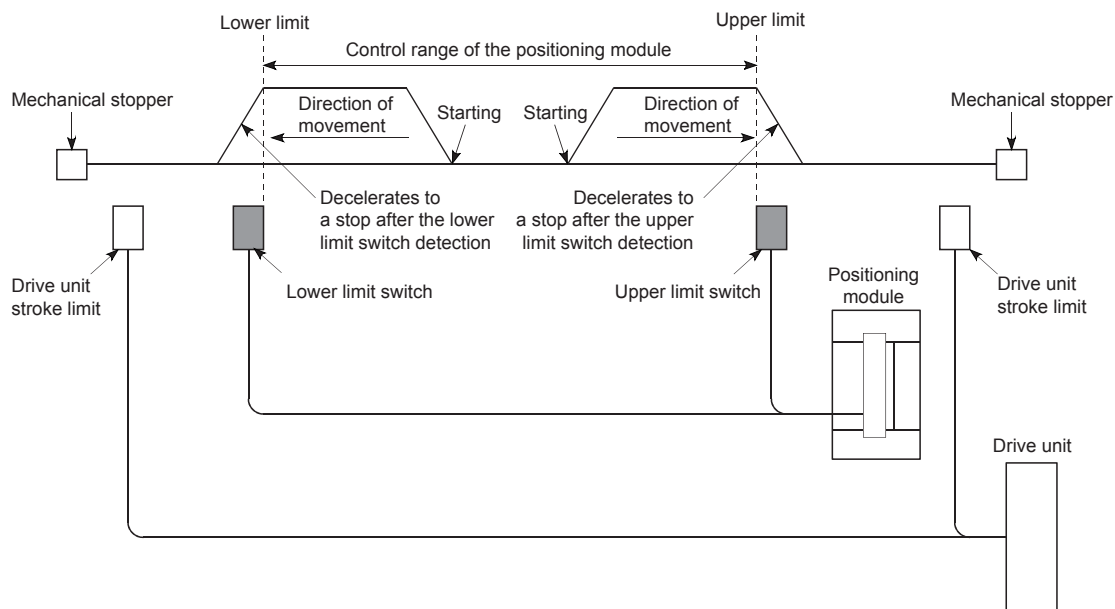

Wiring the hardware stroke limit

When the hardware stroke limit function is used, wire the terminals of the FLS (Upper limit signal) and RLS (Lower limit signal) of the positioning module as illustrated in the following figure. ([Pr.22] Input signal logic selection is initialized)

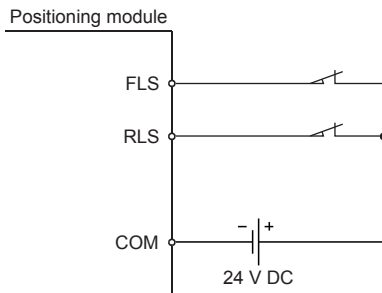

Point

- When wiring the terminals, set the limit switch installed in the direction in which the current feed value increases as the upper limit, and the switch installed in the direction in which the current feed value decreases as the lower limit. If the upper and lower limit switches are wired in incorrect directions, the hardware stroke limit function does not operate properly, and the motor does not stop.
- Adjust the value in [Pr.6] Rotation direction setting so that the increasing or decreasing direction of the current feed value matches with the movement direction of the workpiece. (➤ Page 390 [Pr.6] Rotation direction setting)

Control precautions

- If the machine is stopped outside the positioning module control range (outside the upper/lower limit switches), or is stopped due to the detection of the hardware stroke limit, the OPR control (excluding when the OPR retry function is valid), Major positioning control, and Advanced positioning control cannot be started. To perform these types of the control again, return the workpiece into the positioning module control range using the JOG operation, Inching operation, or Manual pulse generator operation.
- When [Pr.22] Input signal logic selection is set to the initial value, the positioning module cannot perform the positioning control if FLS (Upper limit signal) is separated from COM or RLS (Lower limit signal) is separated from COM (including when not wired).

When the hardware stroke limit function is not used

When the hardware stroke limit function is not used, wire the terminals of the FLS (Upper limit signal) and RLS (Lower limit signal) of the positioning module as illustrated in the following figure.

When Positive logic is set as the logic for FLS and RLS in [Pr.22] Input signal logic selection, the positioning control can be performed even if FLS and RLS are not wired. For details, refer to the following.

➤ Page 314 External I/O Signal Logic Switching Function

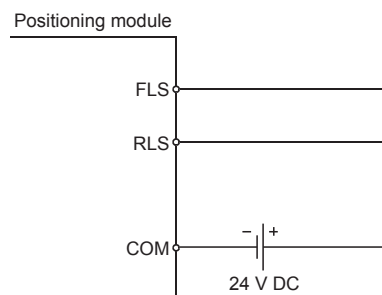

12.5 Functions that Change Control Details

Functions that change the control details include Speed change function, Override function, Acceleration/deceleration time change function, and Torque change function. Each function is executed by setting parameters or creating and writing a program.

Both Speed change function and Override function change the speed. The following shows the differences between these functions. Select one function corresponding to the application.

■Speed change function

- The speed is changed at any timing, only in the control being executed.
- The new speed is directly set.

■Override function

- The speed is changed for all controls to be executed. (Note that the manual pulse generator operation is excluded.)
- The new speed is set in percentage (%) of the command speed.

Speed change function

Speed change function changes the speed of the operation being controlled to a newly specified speed at a specified timing. The new speed is directly set in the buffer memory, and the speed is changed using a speed change command ([Cd.15] Speed change request) or an external command signal.

During the machine OPR, the speed change to the creep speed cannot be performed after the deceleration (or acceleration) start due to the detection of the near-point dog ON.

Control details

The following figure shows the operation during the speed change.

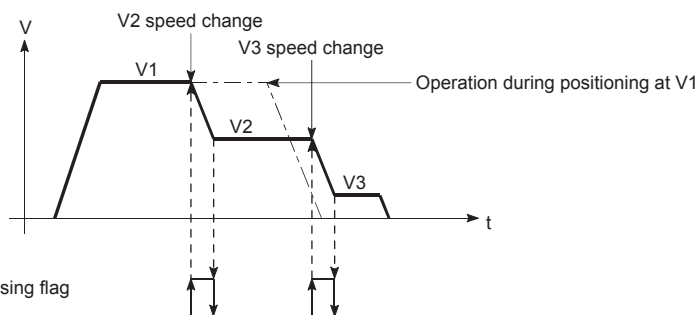

Control precautions

- When the speed is changed during the continuous path control, the next positioning data is controlled with [Cd.14] New speed value if no speed is specified (current speed) in the next positioning data. When a speed is specified in the next positioning data, the next positioning data is controlled at the speed of [Da.8] Command speed.

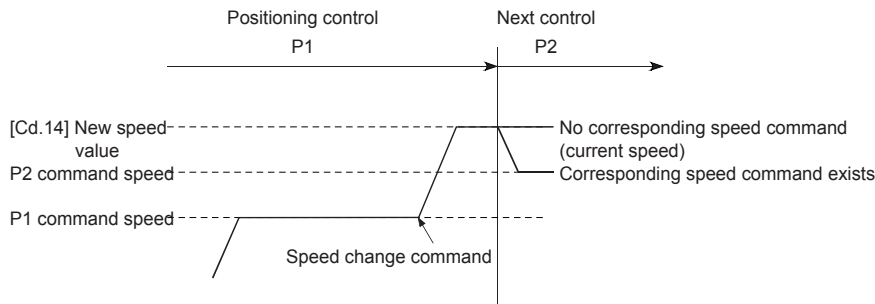

- When the speed is changed during the continuous path control, the speed change is ignored and Insufficient remaining distance (Warning code: 0995H) occurs if a distance enough to perform the speed change cannot be ensured.

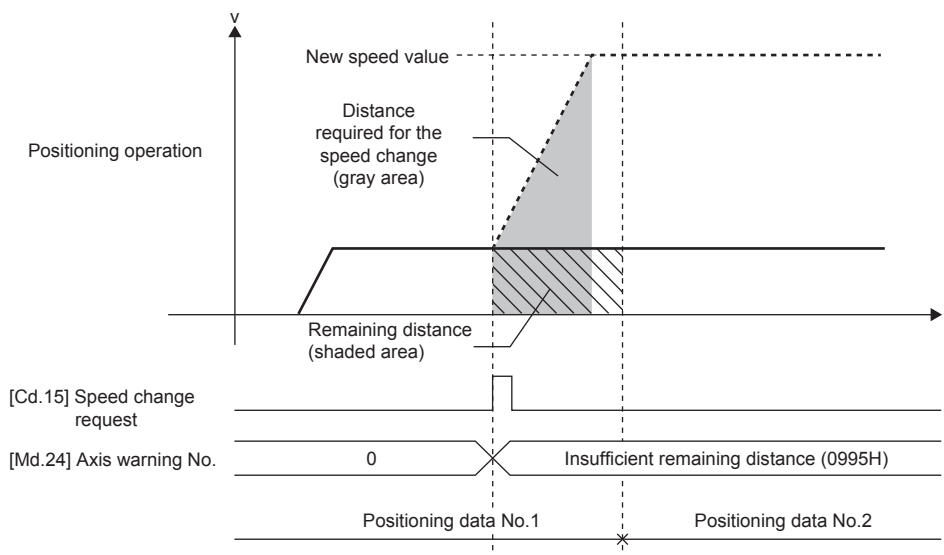

- When the speed is changed by setting [Cd.14] New speed value to 0, the operation is performed as follows.

- When [Cd.15] Speed change request is turned on, Speed change 0 flag ([Md.31] Status: b10) is turned on. (During the interpolation control, Speed change 0 flag on the reference axis side is turned on.)
- The axis stops, but [Md.26] Axis operation status does not change and BUSY signal remains on.
- When a value other than 0 is set in [Cd.14] New speed value and the speed is changed while Speed change 0 flag ([Md.31] Status: b10) is on, Speed change 0 flag ([Md.31] Status: b10) is turned off and the operation continues.
- If a stop signal is input while Speed change 0 flag ([Md.31] Status: b10) is on, BUSY signal turns off and [Md.26] Axis operation status changes to "1: Stopped". In this case, the operation cannot be continued even if a value other than 0 is set in [Cd.14] New speed value and the speed is changed.

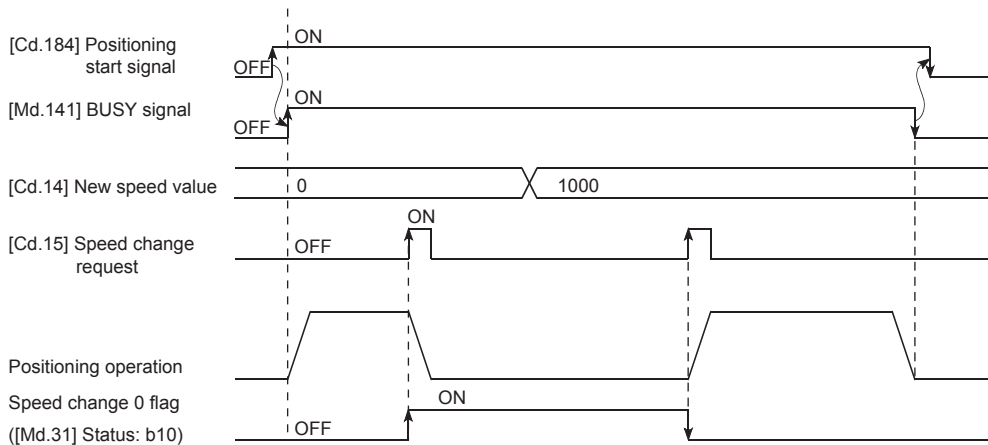

- If the speed is changed during the deceleration by a stop command or during the automatic deceleration in the positioning control, Deceleration/stop speed change (Warning code: 0990H) occurs and the speed cannot be changed.
- When the value set in [Cd.14] New speed value exceeds the one in [Pr.8] Speed limit value, Speed limit value over (Warning code: 0991H) occurs and the speed is controlled with [Pr.8] Speed limit value.
- To change the speed during the interpolation control, configure the required setting in the reference axis.
- To change the speed successively, set 10 ms or longer as the interval between each speed change. (If the interval between the speed changes is short, [Cd.15] Speed change request may not be accepted properly.)
- When a speed change is requested simultaneously to multiple axes, the speed change is performed one by one. Therefore, the start timing of the speed change is different for each axis.
- During the machine OPR, the speed cannot be changed by setting 0 to [Cd.14] New speed value. The speed change request is ignored.
- Deceleration start flag is not turned on when the deceleration is performed using the speed change function.

Setting the function from the CPU module

The following shows the data setting and a program example for changing the control speed of the axis 1 by the command sent from the CPU module. (In this example, the control speed is changed to 20.00 mm/min.)

■Setting data

Set the following data.

Setting item		Setting value	Setting detail	Buffer memory address	
				Axis 1	Axis 2
[Cd.14]	New speed value	2000	Set the new speed.	1514 1515	1614 1615
[Cd.15]	Speed change request	1	Set 1: Change the speed.	1516	1616

For details on the settings, refer to the following.

☞ Page 473 [Cd.14] New speed value

☞ Page 474 [Cd.15] Speed change request

■Time Charts

The following shows the time chart of the speed change.

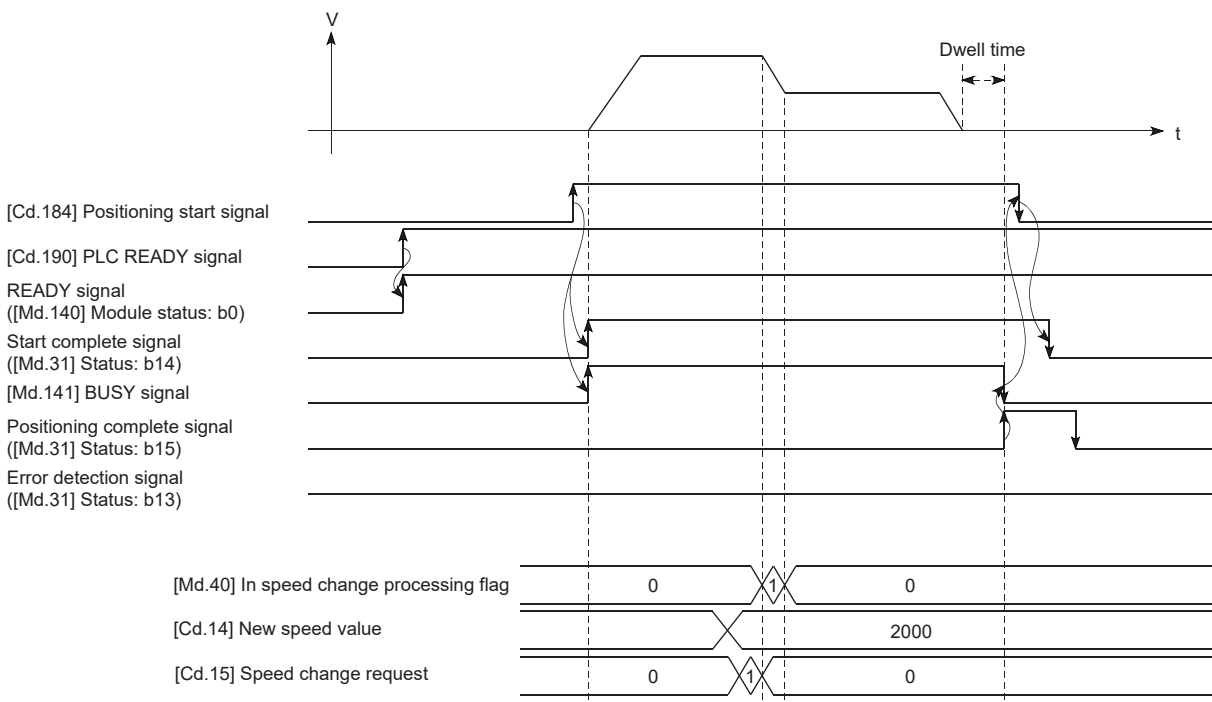

Program example

Add the following program to the control program, and write it to the CPU module.

☞ Page 505 Speed change program

Setting the function using an external command signal

The speed can also be changed using an external command signal.

The following shows the data setting and a program example for changing the control speed of the axis 1 using an external command signal. (In this example, the control speed is changed to 10000.00 mm/min.)

Setting data

Set the following data to perform the speed change using an external command signal.

Setting item	Setting value	Setting detail	Buffer memory address	
			Axis 1	Axis 2
[Pr.42] External command function selection	1	Set 1: External speed change request.	62	212
[Cd.8] External command valid	1	Set 1: Validate external command.	1505	1605
[Cd.14] New speed value	1000000	Set the new speed.	1514 1515	1614 1615

For details on the settings, refer to the following.

☞ Page 412 [Pr.42] External command function selection

☞ Page 471 [Cd.8] External command valid

☞ Page 473 [Cd.14] New speed value

Time Charts

The following shows the time chart of the speed change.

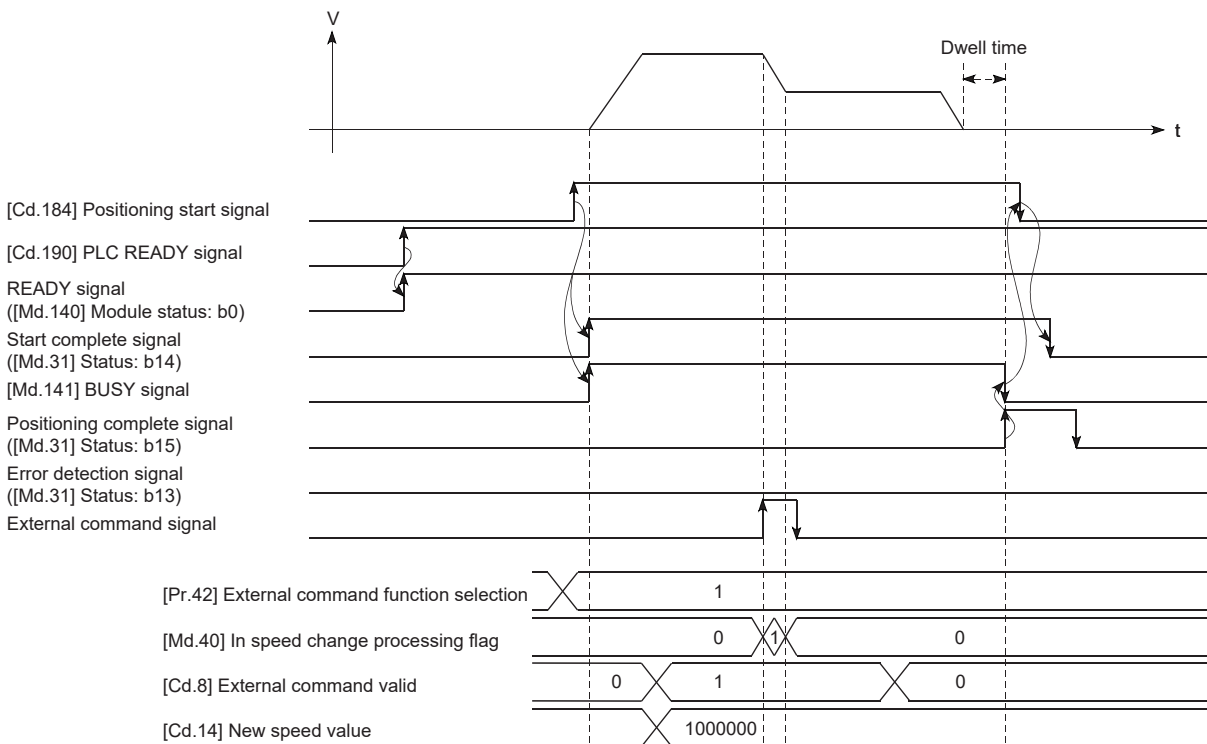

Program example

Add the following program to the control program, and write it to the CPU module.

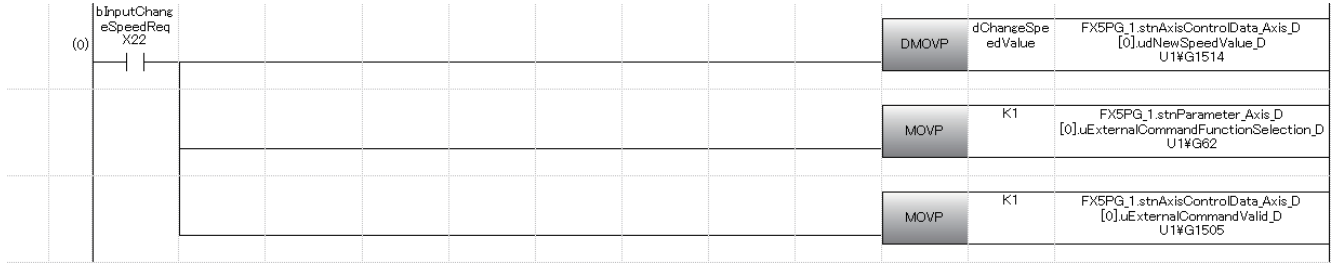

Classification	Label Name	Description										
Module label	FX5PG_1.stnParameter_Axis_D[0].uExternalCommandFunctionSelection_D	Axis 1 External command function selection										
	FX5PG_1.stnAxisControlData_Axis_D[0].uExternalCommandValid_D	Axis 1 External command valid										
	FX5PG_1.stnAxisControlData_Axis_D[0].udNewSpeedValue_D	Axis 1 New speed value										
Global label, local label	Define the global label or local label as follows. Setting Assign (Device/Label) for labels is not necessary because the unused internal relay and data device are automatically assigned to the labels.											
	<table border="1"> <thead> <tr> <th></th> <th>Label Name</th> <th>Data Type</th> <th>Class</th> </tr> </thead> <tbody> <tr> <td>1</td> <td>dChangeSpeedValue</td> <td>Double Word [Unsigned]/Bit String [32-bit]</td> <td>VAR</td> </tr> </tbody> </table>		Label Name	Data Type	Class	1	dChangeSpeedValue	Double Word [Unsigned]/Bit String [32-bit]	VAR			
	Label Name	Data Type	Class									
1	dChangeSpeedValue	Double Word [Unsigned]/Bit String [32-bit]	VAR									
	<table border="1"> <thead> <tr> <th></th> <th>Label Name</th> <th>Data Type</th> <th>Class</th> <th>Assign (Device/Label)</th> </tr> </thead> <tbody> <tr> <td>19</td> <td>blnputChangeSpeedReq</td> <td>Bit</td> <td>VAR_GLOBAL</td> <td>X22</td> </tr> </tbody> </table>		Label Name	Data Type	Class	Assign (Device/Label)	19	blnputChangeSpeedReq	Bit	VAR_GLOBAL	X22	
	Label Name	Data Type	Class	Assign (Device/Label)								
19	blnputChangeSpeedReq	Bit	VAR_GLOBAL	X22								

Override function

Override function changes the command speed by a specified percentage (0 to 300%) for all controls to be executed. The speed can be changed by setting the percentage (%) by which the speed is changed in [Cd.13] Positioning operation speed override.

Control details

The following shows the operation of the override function.

- This function is valid from the moment when the positioning control is started.
- A value changed using the override function is monitored by [Md.22] Feedrate.
- If [Cd.13] Positioning operation speed override is set to 100 (%), the speed does not change.
- If [Cd.13] Positioning operation speed override is set to 1 to 100 (%) and the value in [Md.22] Feedrate is less than 1, Less than speed 1 (Warning code: 0904H) occurs and the control is performed at the speed unit 1 at that time.
- When [Cd.13] Positioning operation speed override is set to 0 (%), the speed becomes 0 and Speed change 0 flag ([Md.31] Status: b10) is turned on.
- When the speed is changed using the override function during the position control or during the position control of the speed-position switching control and position-speed switching control, the operation is performed at a speed for the distance if a distance enough to perform the speed change cannot be ensured.
- If the speed changed using the override function is equal to or greater than the value set in [Pr.8] Speed limit value, Speed limit value over (Warning code: 0991H) occurs and the speed is controlled at the speed set in [Pr.8] Speed limit value. [Md.39] In speed limit flag is turned on.

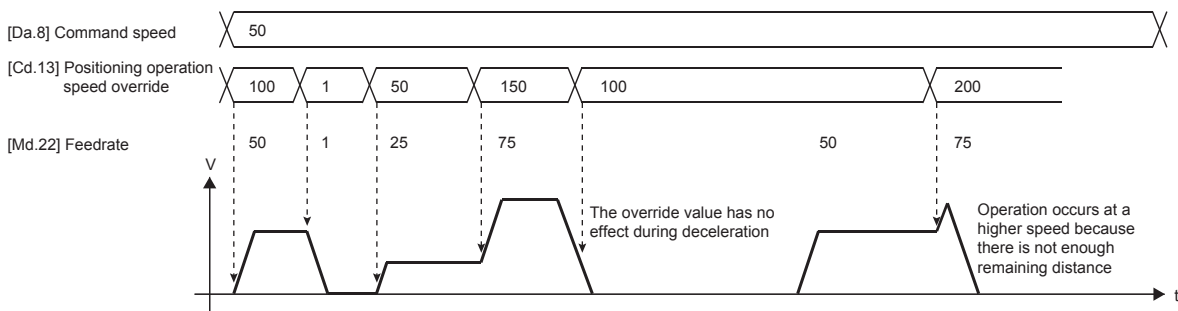

Control precautions

- When the speed is changed using Override function during the continuous path control, the speed change is ignored and Insufficient remaining distance (Warning code: 0995H) occurs if a distance enough to perform the speed change cannot be ensured.

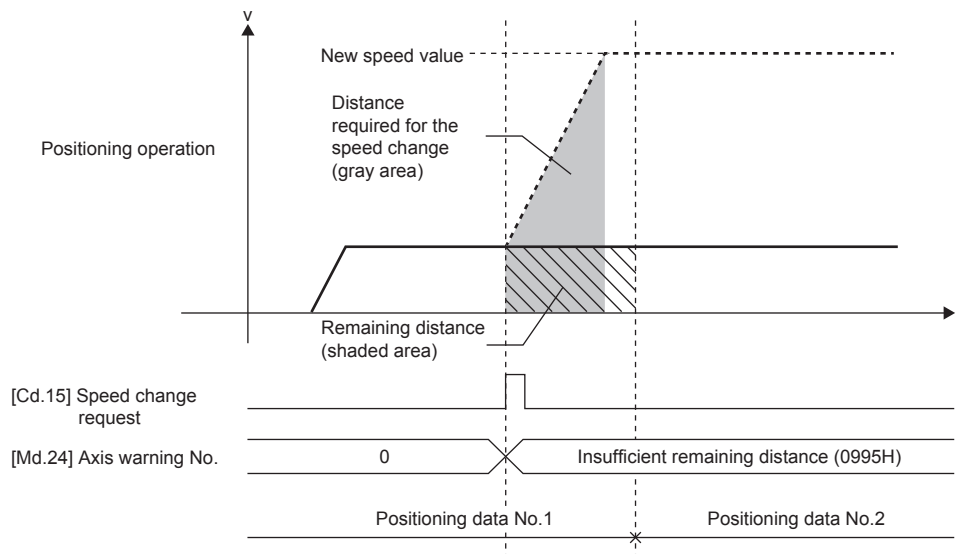

- During the deceleration by a stop command or during the automatic deceleration in the position control, Deceleration/stop speed change (Warning code: 0990H) occurs and the speed cannot be changed using the override function. (The value set in [Cd.13] Positioning operation speed override is validated after the deceleration stop.)
- To change the speed using the override function during the interpolation control, configure the required setting in the reference axis.
- To change the speed successively using the override function, set 10 ms or longer as the interval between each speed change. (If the interval between the speed changes is short, the override value may not be reflected to the speed.)
- When the machine OPR is performed, the speed change using the override function cannot be performed after the start of the deceleration to the creep speed following the detection of the near-point dog ON. In this case, the speed change request is ignored.
- Deceleration start flag is not turned on when the deceleration is performed using the override function.

Setting method

The following shows the data setting and a program example for setting the override value of the axis 1 to 200%.

■Setting data

Set the following data.

Setting item		Setting value	Setting detail	Buffer memory address	
				Axis 1	Axis 2
[Cd.13]	Positioning operation speed override	200	Set the new speed in percentage (%).	1513	1613

For details on the settings, refer to the following.

☞ Page 473 [Cd.13] Positioning operation speed override

■Time Charts

The following shows the time chart of the speed change using the override function.

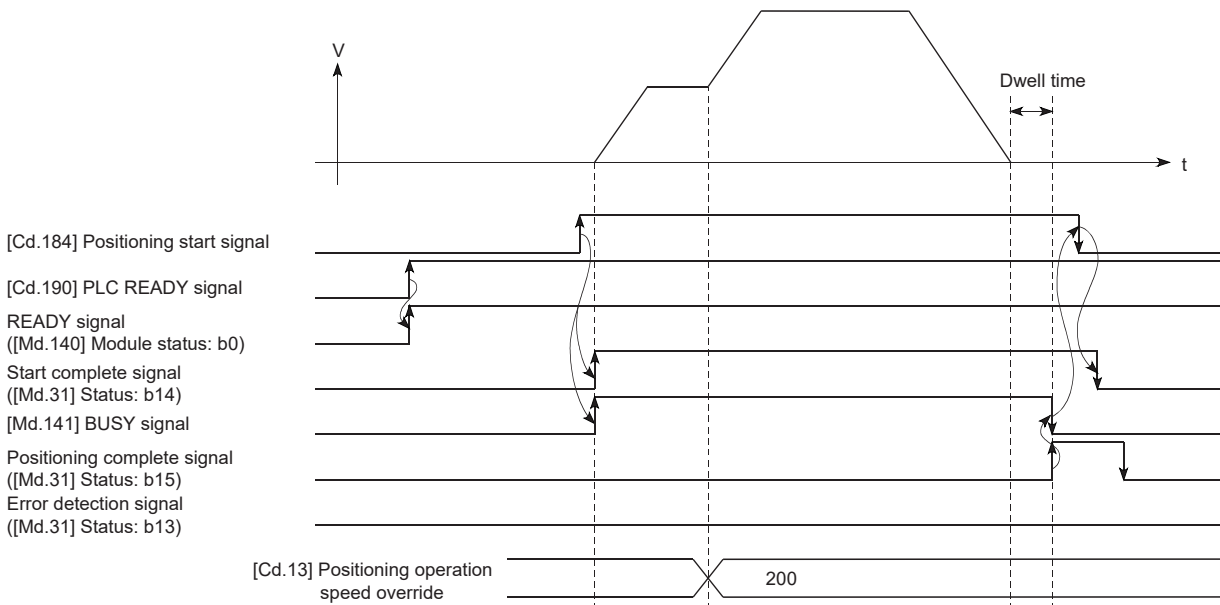

■Program example

Add the following program to the control program, and write it to the CPU module.

☞ Page 505 Override program

Acceleration/deceleration time change function

Acceleration/deceleration time change function is used to change the acceleration/deceleration time during the speed change to an arbitrary value when the speed change is performed using Speed change function and Override function.

In a normal speed change (when the acceleration/deceleration time is not changed), the acceleration/deceleration time previously set in the parameters (values in [Pr.9], [Pr.10], and [Pr.25] to [Pr.30]) is set in [Da.3] and [Da.4] of the positioning data, and the control is performed with that acceleration/deceleration time. However, by setting a new acceleration/deceleration time ([Cd.10] and [Cd.11]) to the control data, and issuing an acceleration/deceleration time change enable command ([Cd.12] Acceleration/deceleration time change during speed change, enable/disable selection) to change the speed when the acceleration/deceleration time change is enabled, the speed will be changed with the new acceleration/deceleration time ([Cd.10] and [Cd.11]).

Control details

After setting the following two items, perform the speed change to change the acceleration/deceleration time at the speed change.

- Setting a new value of the acceleration/deceleration time ([Cd.10] New acceleration time value, [Cd.11] New deceleration time value)
- Enabling the acceleration/deceleration time change ([Cd.12] Acceleration/deceleration time change during speed change, enable/disable selection)

The following figure shows the operation at the acceleration/deceleration time change.

■ When Acceleration/deceleration time change disabled is set

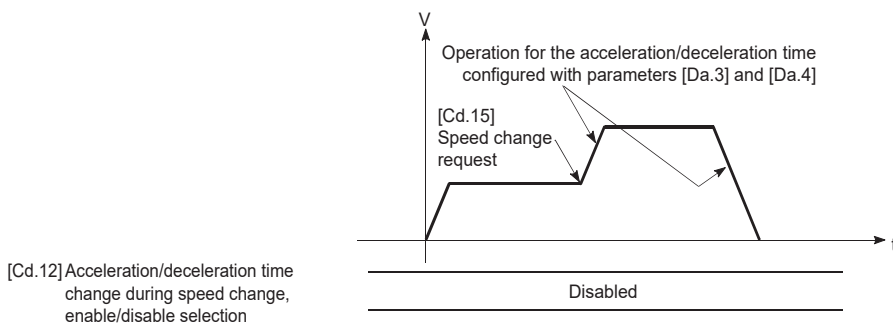

■ When Acceleration/deceleration time change enabled is set

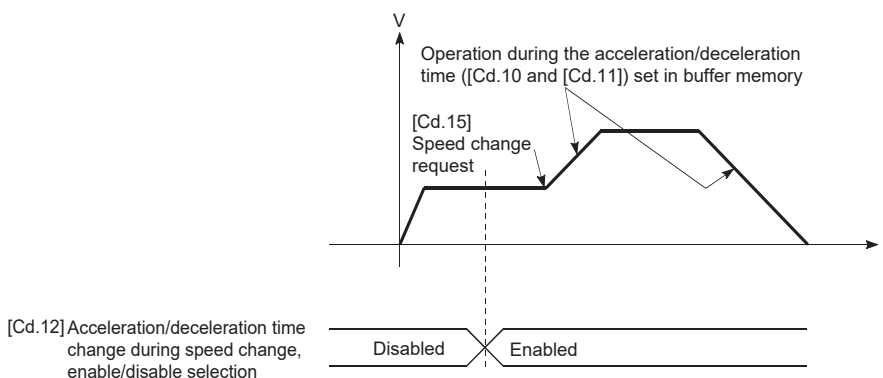

Control precautions

- When 0 is set in [Cd.10] New acceleration time value and [Cd.11] New deceleration time value, the acceleration/ deceleration time is not changed even if the speed change is performed. In this case, the operation is controlled at the acceleration/deceleration time previously set in the parameters.
- New acceleration/deceleration time is valid during the execution of the positioning data for which the speed change was performed. In the continuous positioning control and continuous path control, even though the speed change is performed and the acceleration/deceleration time has been changed to the new acceleration/deceleration time ([Cd.10] and [Cd.11]), the control will be performed at the previously set acceleration/deceleration time when switching to the next positioning data is performed.
- Even if the acceleration/deceleration time change is set to be disabled after New acceleration/deceleration time is validated, the positioning data for which New acceleration/deceleration time was validated continues to be controlled with that value. (The next positioning data is controlled at the acceleration/deceleration time set in the parameters in advance.)

[Example]

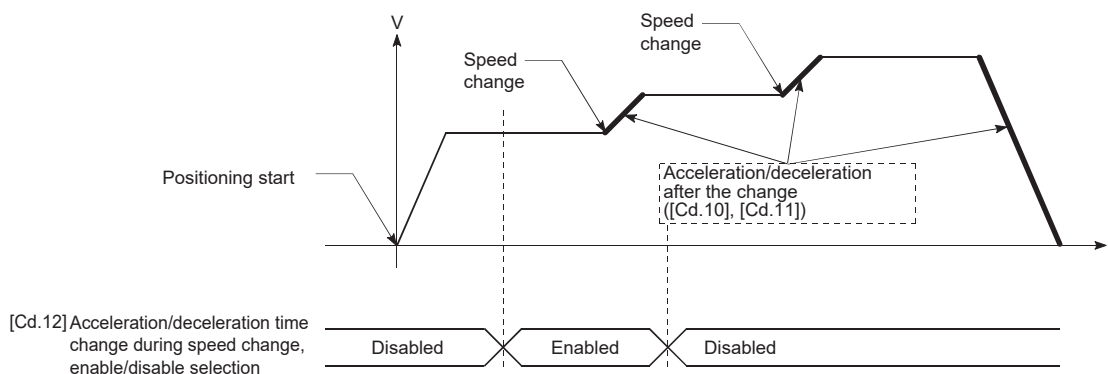

- If New acceleration/deceleration time is set to 0 and the speed change is performed after New acceleration/deceleration time is validated, the operation is controlled at the previous New acceleration/deceleration time.

[Example]

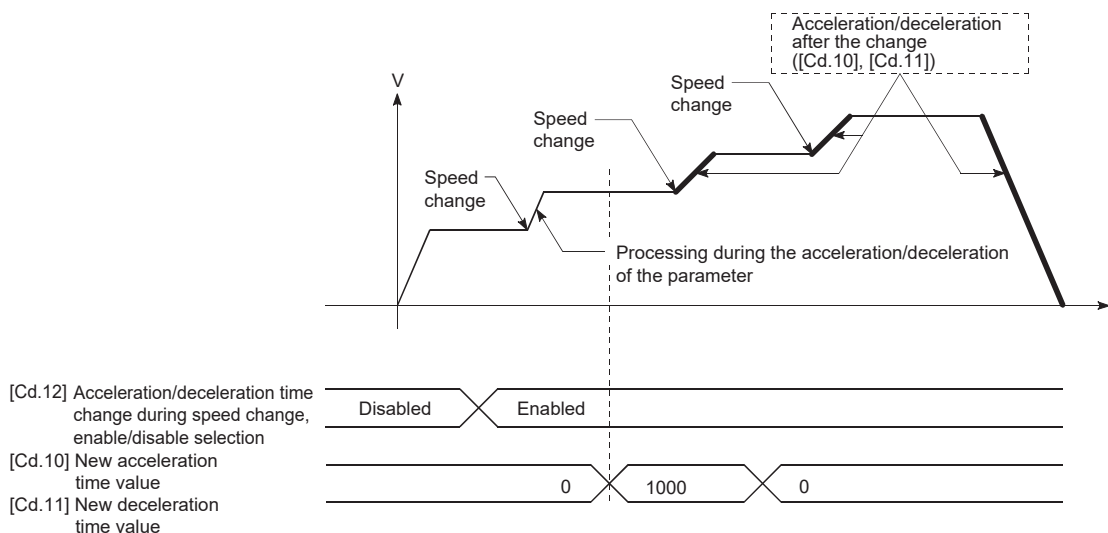

Point

If the speed change is performed when the acceleration/deceleration time change is enabled, New acceleration/deceleration time becomes the acceleration/deceleration time for the positioning data being executed. New acceleration/deceleration time remains valid until switching to the next positioning data is performed. (The automatic deceleration processing at the completion of the positioning is also controlled at the new deceleration time.)

Setting method

To use the acceleration/deceleration time change function, write the following data into the positioning module using a program.

The following shows the data setting and a program example for changing the acceleration/deceleration time of the axis 1 by the command sent from the CPU module. (In this example, the acceleration time is changed to 2000 ms and the deceleration time is changed to 0 (the deceleration time is not changed).)

The set data becomes valid when the data is written into the positioning module and the speed change is performed.

■Setting data

Set the following data.

Setting item		Setting value	Setting detail	Buffer memory address	
				Axis 1	Axis 2
[Cd.10]	New acceleration time value	2000	Set the new acceleration time.	1508 1509	1608 1609
[Cd.11]	New deceleration time value	0	Set the new deceleration time.	1510 1511	1610 1611
[Cd.12]	Acceleration/deceleration time change during speed change, enable/disable selection	1	Set 1: Acceleration/deceleration time change enabled.	1512	1612

For details on the settings, refer to the following.

☞ Page 472 [Cd.10] New acceleration time value

☞ Page 472 [Cd.11] New deceleration time value

☞ Page 473 [Cd.12] Acceleration/deceleration time change during speed change, enable/disable selection

■Program example

Add the following program to the control program, and write it to the CPU module.

☞ Page 506 Acceleration/deceleration time change program

Torque change function

Torque change function changes the torque limit value during the control. The torque limit value during the control is normally the value in [Pr.17] Torque limit setting value that was previously set in the parameters. However, by setting a new torque limit value in [Cd.22] New torque value, the axis control data, and writing it to the positioning module, the torque generated in the servomotor during the control can be limited with the new torque value. ([Cd.22] New torque value is validated when the value is written to the positioning module.)

Control details

The setting of [Cd.22] New torque value is reflected to [Md.35] Torque limit stored value when the first [Cd.190] PLC READY signal is turned on after the power-on. After [Cd.190] PLC READY signal is turned on, the setting of [Cd.22] New torque value is always reflected to [Md.35] Torque limit stored value every time [Cd.22] New torque value is changed.

To return the value in [Md.35] Torque limit stored value to the value in [Pr.17] Torque limit setting value after the torque is changed, set 0 in [Cd.22] New torque value and turn off and on [Cd.190] PLC READY signal. (If [Cd.22] New torque value was 0 when [Cd.190] PLC READY signal is turned on, the value in [Pr.17] Torque limit setting value is set to [Md.35] Torque limit stored value.)

The setting range is between 0 and [Pr.17] Torque limit setting value. When the new torque value is 0, a torque change is considered not to be performed.

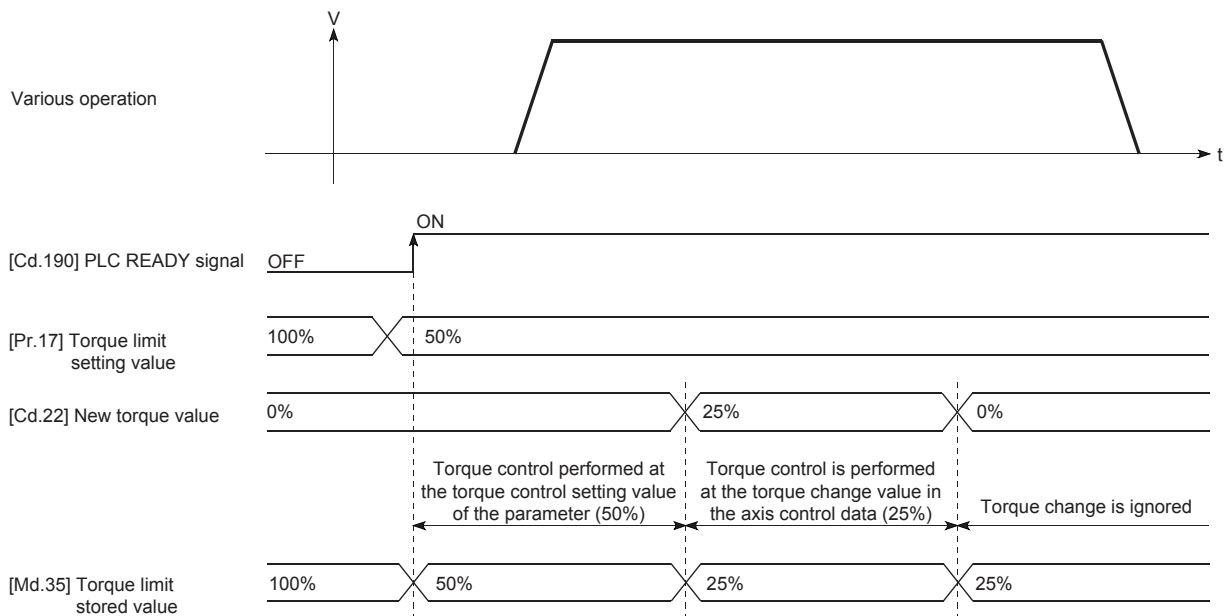

Control precautions

- If a value other than 0 is set in [Cd.22] New torque value, the torque generated in the servomotor is limited with that value. To limit the torque with the value set in [Pr.17] Torque limit setting value, set 0 in [Cd.22] New torque value.
- [Cd.22] New torque value is validated when the value is written to the positioning module. (Note that [Cd.22] New torque value is not validated from when the power supply is turned on to when [Cd.190] PLC READY signal is turned on.)
- If the set value is outside the setting range, Outside new torque value range (Warning code: 0907H) occurs and the torque is not changed.
- To change the torque successively using the torque change function, set 10 ms or longer as the interval between each torque change. (If the interval between the torque changes is short, the new torque value may not be reflected to the torque.)

Setting method

To use the torque change function, write the following data into the positioning module using a program.

The set data is validated when the data is written into the positioning module.

Setting item		Setting value	Setting detail	Buffer memory address	
				Axis 1	Axis 2
[Cd.22]	New torque value	→	Set the new torque limit value.	1525	1625

For details on the settings, refer to the following.

 Page 476 [Cd.22] New torque value

Target position change function

Target position change function changes a target position to a newly specified target position at a specified timing during the position control (1-axis linear control). The command speed can also be changed simultaneously with the target position change.

The new target position and command speed are set directly in the buffer memory, and the target position change is performed by turning on [Cd.29] Target position change request flag.

Control details

The following describes the control details of the target position change function.

- When the address after change is farther from the start point than the positioning address

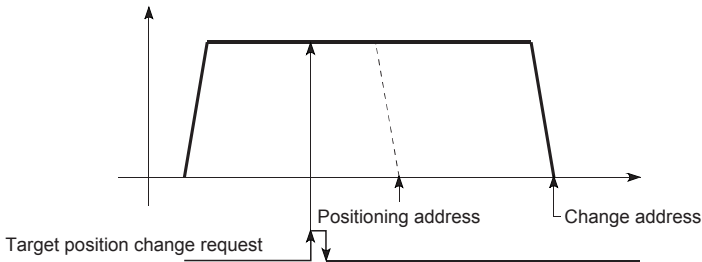

- When the speed is changed simultaneously with the address change

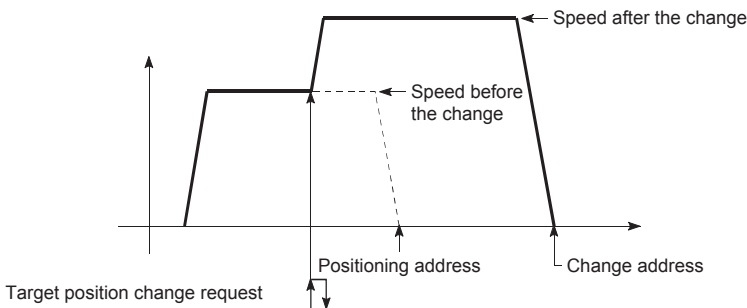

- When the direction of the operation is changed

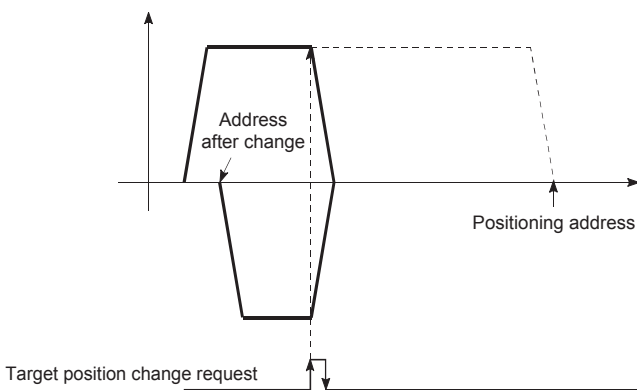

Control precautions

- If the positioning movement direction from the stop position to a new target position is reversed, the operation stops once and the positioning to the new target position is performed.
- If a command speed exceeding the speed limit value is set to change the command speed, Speed limit value over (Warning code: 0991H) occurs, and the new command speed becomes the speed limit value. Also, if a distance to the target value cannot be ensured due to the command speed change, Insufficient remaining distance (Warning code: 0995H) occurs.
- When [Cd.29] Target position change request flag is turned on in the following cases, the target position change request is ignored and a warning occurs.

Warning code	Warning name	Occurrence condition
099BH	Target position change not possible	During the interpolation control
099CH	Target position change not possible	While the positioning data whose operation pattern is the continuous path control is executed
099FH	Target position change not possible	The target position change value (new address) is outside the software stroke limit range.
09A0H		
09A1H	Target position change not possible	The target position change value (new address) is outside the range when [Pr.1] Unit setting is set to "2: degree".
099DH	Target position change not possible	When the deceleration stop is performed due to a stop cause
099EH	Target position change not possible	When Speed change 0 flag ([Md.31] Status: b10) is on

- When the command speed is changed, the current speed is also changed. When the current speed is used as the next positioning speed in the continuous positioning, the next positioning operation is performed with the new speed value. When the speed is set with the next positioning data, that speed becomes the current speed and the operation is performed at the current speed.
- When a target position change request is given during the automatic deceleration in the position control and the movement direction is reversed, the positioning control to a new position is performed after the positioning has stopped once. If the movement direction is not reversed, the speed accelerates to the command speed again and the positioning to the new position is performed.
- Even though the speed changes to the constant speed or the output is reversed by performing the target position change while [Md.48] Deceleration start flag is on, Deceleration start flag remains on. ( Page 300 Deceleration start flag function)
- When the speed does not need to be changed, set 0 in [Cd.28] Target position change value (new speed).
- When the target position change is performed to the ABS linear 1 in degrees, the positioning to the new target position may be performed after the deceleration stop was performed once even though the movement direction is not is reversed.

Restriction

To change the target position successively, set 10 ms or longer as the interval between each target position change. Set 10 ms or longer interval for the speed change or override after the target position change or for the target position change after the speed change or override.

Setting the function from the CPU module

The following shows the data setting and a program example for changing the target position of the axis 1 by the command sent from the CPU module. (In this example, the target position is changed to 300.0 μm and the command speed is changed to 10000.00 mm/min.)

Setting data

Set the following data.

Setting item		Setting value	Setting detail	Buffer memory address	
				Axis 1	Axis 2
[Cd.27]	Target position change value (new address)	3000	Set the new address.	1534 1535	1634 1635
[Cd.28]	Target position change value (new speed)	1000000	Set the new speed.	1536 1537	1636 1637
[Cd.29]	Target position change request flag	1	Set "1: Target position change request".	1538	1638

For details on the settings, refer to the following.

- ☞ Page 478 [Cd.27] Target position change value (new address)
- ☞ Page 478 [Cd.28] Target position change value (new speed)
- ☞ Page 478 [Cd.29] Target position change request flag

Time Charts

The following shows the time chart of the target position change.

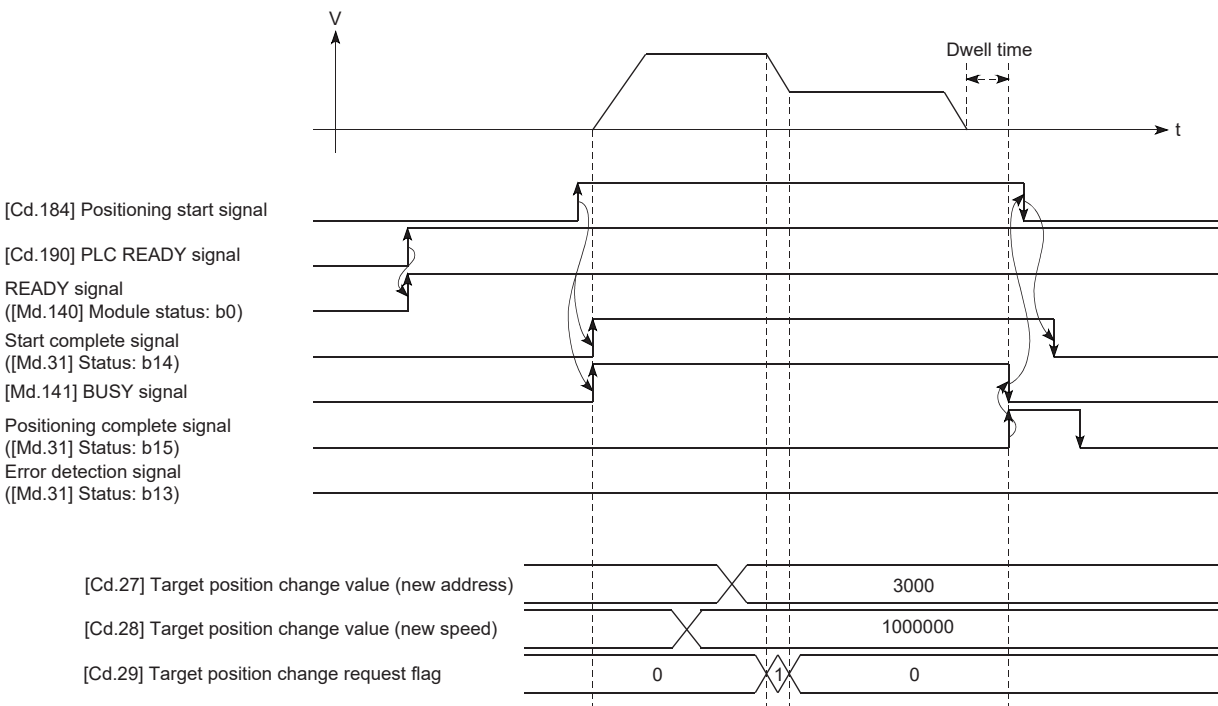

Program example

Add the following program to the control program, and write it to the CPU module.

- ☞ Page 507 Target position change program

12.6 Function Related to Start

As the functions related to start, Pre-reading start function and Start time adjustment function are provided. Each function is executed by setting parameters or creating and writing a program.

Pre-reading start function

Pre-reading start function does not output pulses while Execution prohibition flag is on if a positioning start request is given with the Execution prohibition flag on, and starts outputting pulses within 0.88 ms after the off state of Execution prohibition flag is detected.

Control details

The pre-reading start function is performed by turning on "[Cd.184] Positioning start signal" or executing the dedicated instruction (GP. PSTRT□) while "[Cd.183] Execution prohibition flag" is on. If the positioning is started while Execution prohibition flag is on, the positioning data is analyzed but pulses are not output. While Execution prohibition flag is on, the setting of [Md.26] Axis operation status remains 5: Analyzing. When [Cd.183] Execution prohibition flag is turned off, the pulse starts outputting pulses within 0.88 ms, and changes [Md.26] Axis operation status to the status (such as Position control and In speed control) according to the control method used.

The pre-reading start function is invalid if Execution prohibition flag is turned off in the time between when Positioning start signal is turned on and when the analysis of the positioning data is completed ($T_a < \text{Start time}$). (T_a is the time from when [Cd.184] Positioning start signal is turned on to when [Cd.183] Execution prohibition flag is turned off.)

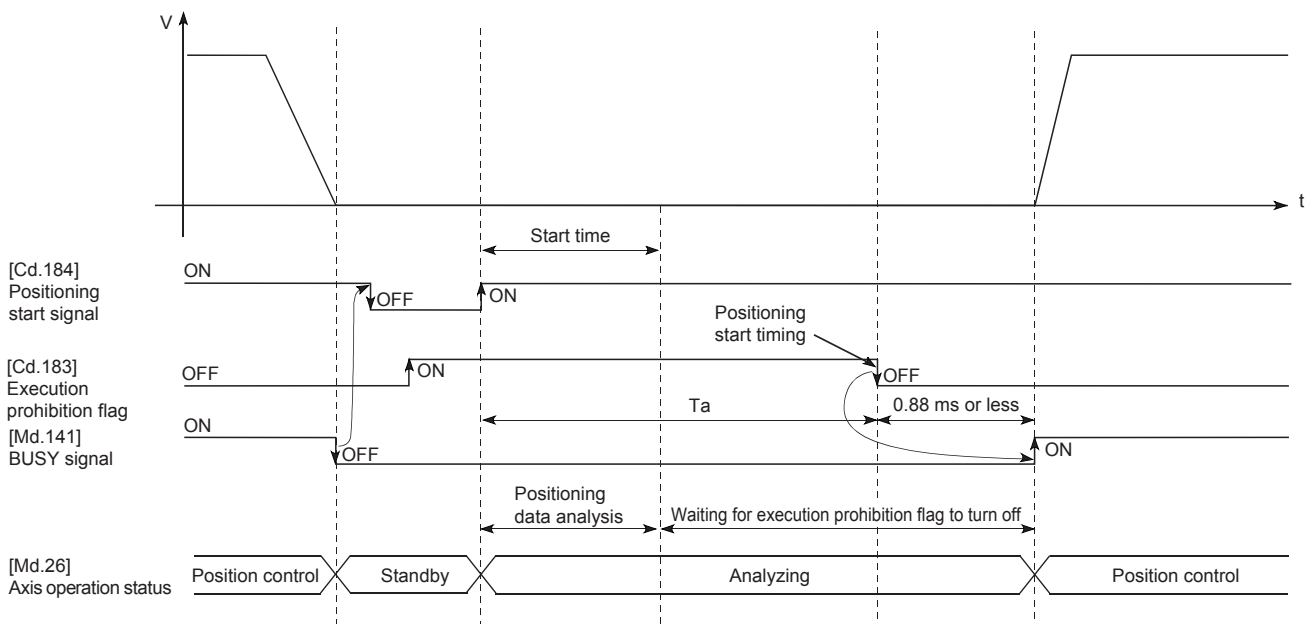

Control precautions

- The time required to analyze the positioning data is up to 7 ms.
- After the positioning data analysis, the system is put in the execution prohibition flag OFF waiting state. Any change made to the positioning data in the execution prohibition flag OFF waiting state is not reflected on the positioning data. Change the positioning data before turning on Positioning start signal.
- The data numbers (set in [Cd.3] Positioning start No.) that can be used for the positioning start using the pre-reading start function are from No.1 to 600. If any number between 7000 to 7004 or 9001 to 9004 is set and the pre-reading start function is performed, Outside start No. range (Error code: 19A3H) occurs.
- Always turn on Execution prohibition flag at the same time or before turning on Positioning start signal. Pre-reading may not be started if Execution prohibition flag is turned on after Positioning start signal is turned on and during T_a . The pre-reading start function is invalid if Execution prohibition flag is turned on after the positioning start (pulse output) is performed while Execution prohibition flag is off. (The function is enabled at the next positioning start.)

Program example

The following shows a program example of the pre-reading start function.

■Using [Cd.184] Positioning start signal

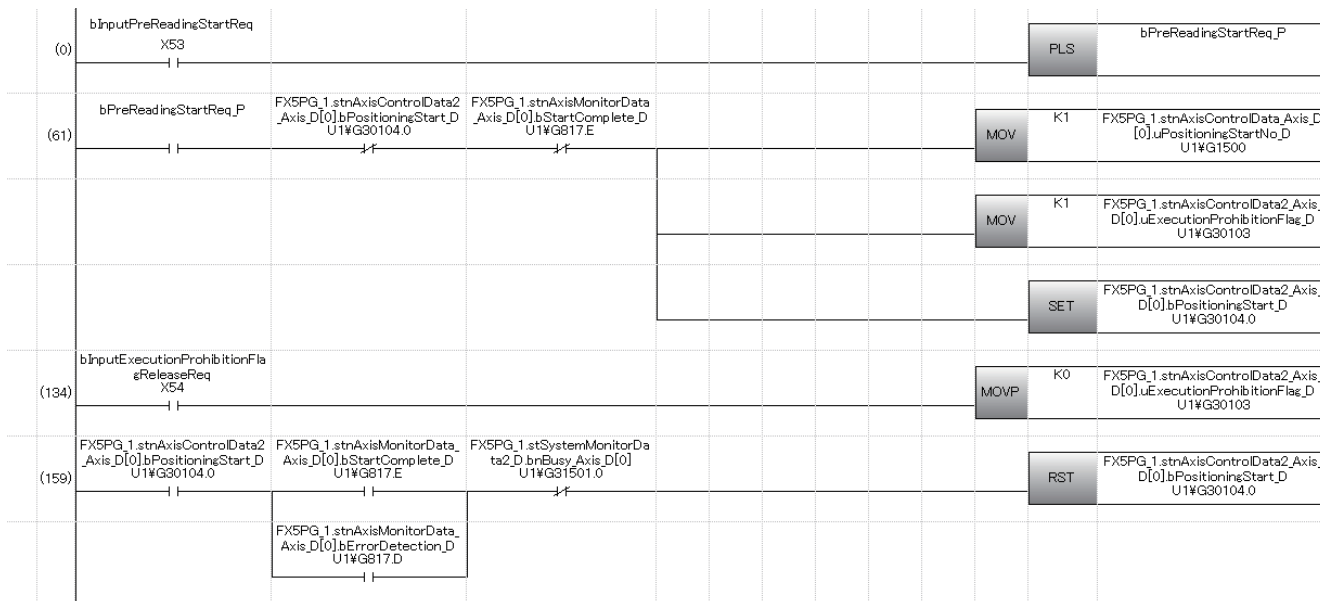

Classification	Label Name	Description												
Module label	FX5PG_1.stnAxisMonitorData_Axis_D[0].bErrorDetection_D	Error detection signal												
	FX5PG_1.stSystemMonitorData2_D.bnBusy_Axis_D[0]	Axis 1 BUSY signal												
	FX5PG_1.stnAxisMonitorData_Axis_D[0].bStartComplete_D	Axis 1 Start complete signal												
	FX5PG_1.stnAxisControlData2_Axis_D[0].bPositioningStart_D	Axis 1 Positioning start signal												
	FX5PG_1.stnAxisControlData2_Axis_D[0].uExecutionProhibitionFlag_D	Axis 1 Execution prohibition flag												
	FX5PG_1.stnAxisControlData_Axis_D[0].uPositioningStartNo_D	Axis 1 Positioning start number												
Global label, local label	Define the global label or local label as follows. Setting Assign (Device/Label) for labels is not necessary because the unused internal relay and data device are automatically assigned to the labels.													
	<table border="1"> <thead> <tr> <th>Label Name</th> <th>Data Type</th> <th>Class</th> </tr> </thead> <tbody> <tr> <td>1 bPreReadingStartReq_P</td> <td>Bit</td> <td>VAR</td> </tr> </tbody> </table>	Label Name	Data Type	Class	1 bPreReadingStartReq_P	Bit	VAR							
Label Name	Data Type	Class												
1 bPreReadingStartReq_P	Bit	VAR												
	<table border="1"> <thead> <tr> <th>Label Name</th> <th>Data Type</th> <th>Class</th> <th>Assign (Device/Label)</th> </tr> </thead> <tbody> <tr> <td>42 bInputPreReadingStartReq</td> <td>Bit</td> <td>VAR_GLOBAL</td> <td>X53</td> </tr> <tr> <td>43 bInputExecutionProhibitionFlagReleaseReq</td> <td>Bit</td> <td>VAR_GLOBAL</td> <td>X54</td> </tr> </tbody> </table>	Label Name	Data Type	Class	Assign (Device/Label)	42 bInputPreReadingStartReq	Bit	VAR_GLOBAL	X53	43 bInputExecutionProhibitionFlagReleaseReq	Bit	VAR_GLOBAL	X54	
Label Name	Data Type	Class	Assign (Device/Label)											
42 bInputPreReadingStartReq	Bit	VAR_GLOBAL	X53											
43 bInputExecutionProhibitionFlagReleaseReq	Bit	VAR_GLOBAL	X54											

■When the dedicated instruction (GP.PSTRT□) is used

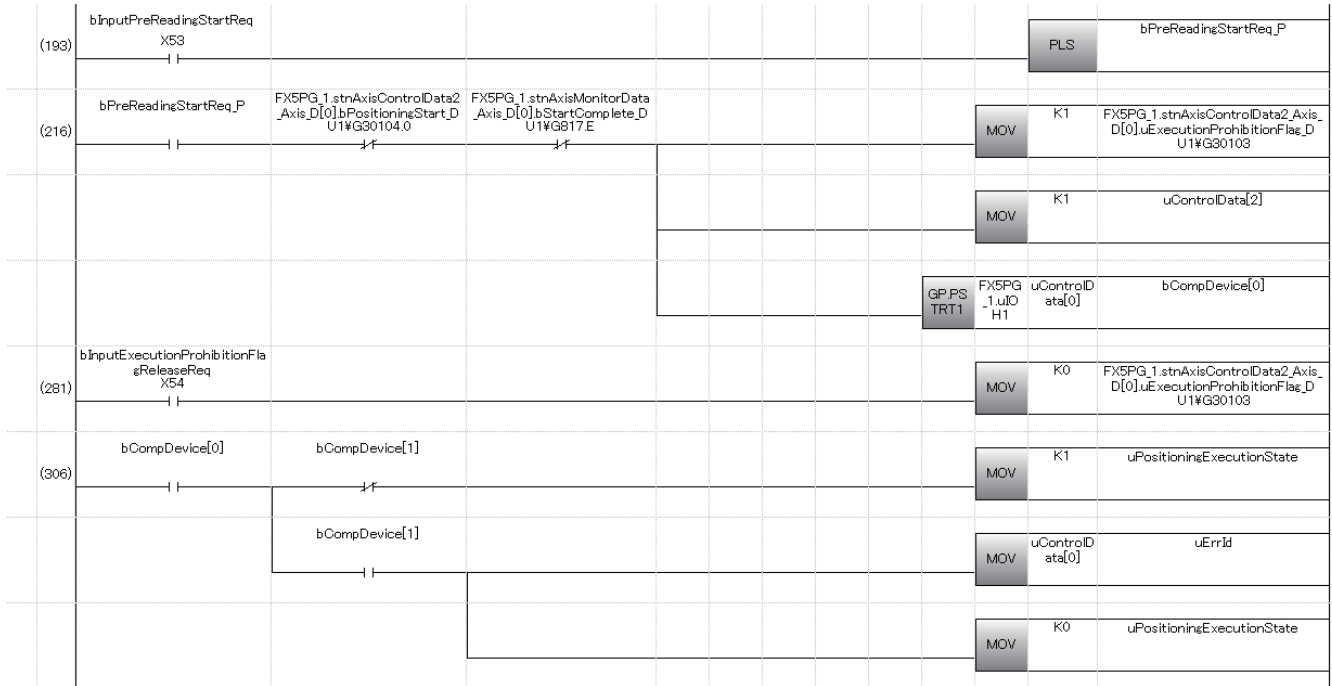

Classification	Label Name	Description																								
Module label	FX5PG_1.stnAxisMonitorData_Axis_D[0].bStartComplete_D	Axis 1 Start complete signal																								
	FX5PG_1.stnAxisControlData2_Axis_D[0].bPositioningStart_D	Axis 1 Positioning start signal																								
	FX5PG_1.stnAxisControlData2_Axis_D[0].uExecutionProhibitionFlag_D	Axis 1 Execution prohibition flag																								
Global label, local label	Define the global label or local label as follows. Setting Assign (Device/Label) for labels is not necessary because the unused internal relay and data device are automatically assigned to the labels.																									
	<table border="1"> <thead> <tr> <th></th> <th>Label Name</th> <th>Data Type</th> <th>Class</th> </tr> </thead> <tbody> <tr> <td>1</td> <td>bPreReadingStartReq_P</td> <td>Bit</td> <td>VAR</td> </tr> <tr> <td>2</td> <td>uControlData</td> <td>Word [Unsigned]/Bit String [16-bit](0.2)</td> <td>VAR</td> </tr> <tr> <td>3</td> <td>bCompDevice</td> <td>Bit(0.1)</td> <td>VAR</td> </tr> <tr> <td>4</td> <td>uPositioningExecutionState</td> <td>Word [Signed]</td> <td>VAR</td> </tr> <tr> <td>5</td> <td>uErrId</td> <td>Word [Signed]</td> <td>VAR</td> </tr> </tbody> </table>		Label Name	Data Type	Class	1	bPreReadingStartReq_P	Bit	VAR	2	uControlData	Word [Unsigned]/Bit String [16-bit](0.2)	VAR	3	bCompDevice	Bit(0.1)	VAR	4	uPositioningExecutionState	Word [Signed]	VAR	5	uErrId	Word [Signed]	VAR	
	Label Name	Data Type	Class																							
1	bPreReadingStartReq_P	Bit	VAR																							
2	uControlData	Word [Unsigned]/Bit String [16-bit](0.2)	VAR																							
3	bCompDevice	Bit(0.1)	VAR																							
4	uPositioningExecutionState	Word [Signed]	VAR																							
5	uErrId	Word [Signed]	VAR																							
	<table border="1"> <thead> <tr> <th></th> <th>Label Name</th> <th>Data Type</th> <th>Class</th> <th>Assign (Device/Label)</th> </tr> </thead> <tbody> <tr> <td>42</td> <td>bInputPreReadingStartReq</td> <td>Bit</td> <td>VAR_GLOBAL</td> <td>X53</td> </tr> <tr> <td>43</td> <td>bInputExecutionProhibitionFlagReleaseReq</td> <td>Bit</td> <td>VAR_GLOBAL</td> <td>X54</td> </tr> </tbody> </table>		Label Name	Data Type	Class	Assign (Device/Label)	42	bInputPreReadingStartReq	Bit	VAR_GLOBAL	X53	43	bInputExecutionProhibitionFlagReleaseReq	Bit	VAR_GLOBAL	X54										
	Label Name	Data Type	Class	Assign (Device/Label)																						
42	bInputPreReadingStartReq	Bit	VAR_GLOBAL	X53																						
43	bInputExecutionProhibitionFlagReleaseReq	Bit	VAR_GLOBAL	X54																						

Start time adjustment function

Start time adjustment function is used together with Quick start function to adjust the time from when a positioning start trigger is input to when the pulse starts outputting pulses.



This function allows users to make a fine adjustment in the start timing without repositioning a sensor.

Control details

The start time adjustment function starts the positioning after a positioning start trigger is input and the time set in [Pr.82] Start adjustment time elapses, as shown in the following figure.

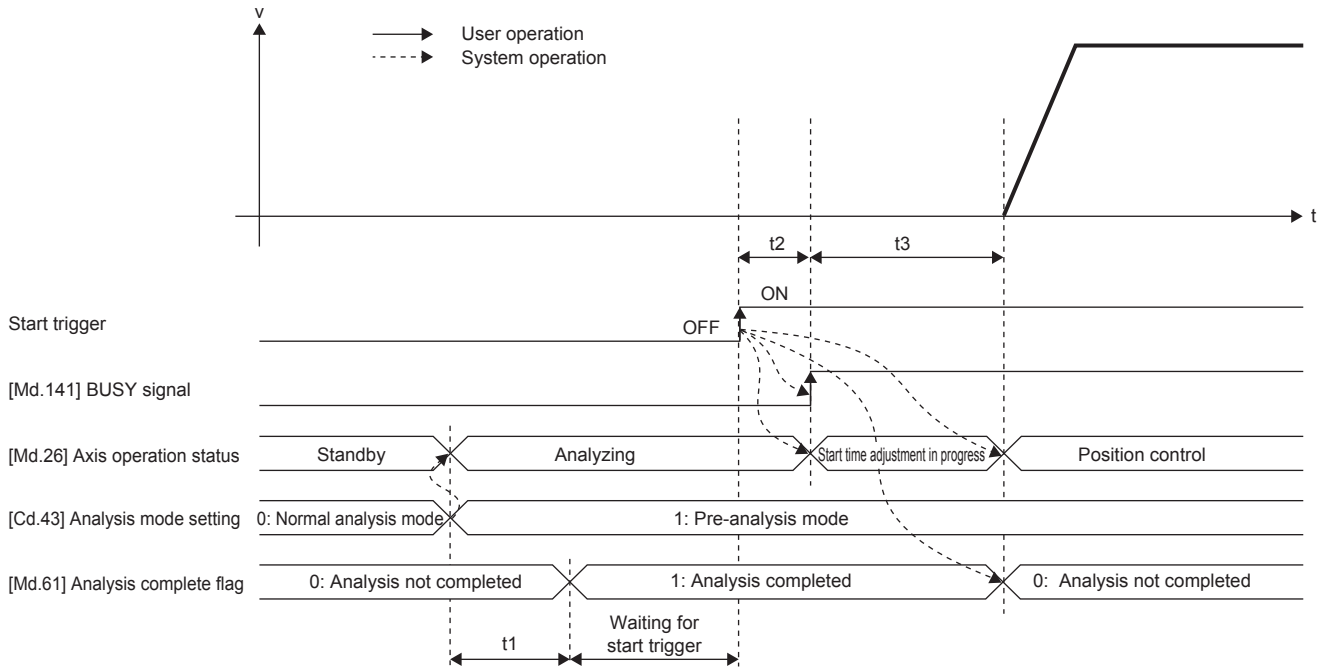

Normal timing time

t1	t2*1	t3
0.88 to 1.77 ms	External command signal: 20 μs Positioning start signal: 30 μs	[Pr.82] Start adjustment time

*1 The start time for when the quick start function is used.

Restrictions

- The start time adjustment function is valid only for Quick start.
- For [Pr.82] Start adjustment time, the setting at the analysis of the positioning data is valid.
- Turn on a start trigger after the analysis of the positioning data is completed. If a start trigger is turned on before the analysis is completed, Pre-analysis incomplete start (Warning code: 09A2H) occurs and the positioning module starts outputting pulses immediately after the analysis is completed.

Point

If a positioning start trigger is turned on before the analysis of the positioning data is completed, the pulse starts outputting pulses immediately after the analysis is completed and the variation in the start timing becomes large.

Setting method

To use the start time adjustment function, write the following data into the positioning module using a program.

The set data is validated when the data is written into the positioning module.

Setting item	Setting value	Setting detail	Buffer memory address	
			Axis 1	Axis 2
[Pr.82]	Start adjustment time	0 to 1000000 Set the adjustment time for pulse outputs. 0.00 to 10000.00 ms (in increments of 0.01 ms)	134 135	284 285

For details on the settings, refer to the following.

 Page 412 [Pr.82] Start adjustment time

Precautions

Even if a single value is set in [Pr.82] Start adjustment time of multiple positioning modules, the actual start adjustment times may differ due to the characteristic of each positioning module. If multiple positioning modules start the positioning simultaneously or a positioning module is replaced, adjust the value in [Pr.82] Start adjustment time again.

12.7 Absolute Position Restoration Function

Absolute position restoration function restores the absolute position of the specified axis using the absolute position detection system. When this function is used, the OPR after power off due to an instantaneous power failure and emergency stop is not required, and the restoration operation at site can be performed easily.

Precautions

An absolute position restoration by the positioning function may turn off Servo ON signal (servo off) for approximately 60 ms + scan time, and the motor may run unexpectedly. If this causes a problem, provide an electromagnetic brake to lock the motor during absolute position restoration.

Configuration and preparation of the absolute position detection system

Configuration

The following figure shows the configuration of the absolute position detection system.

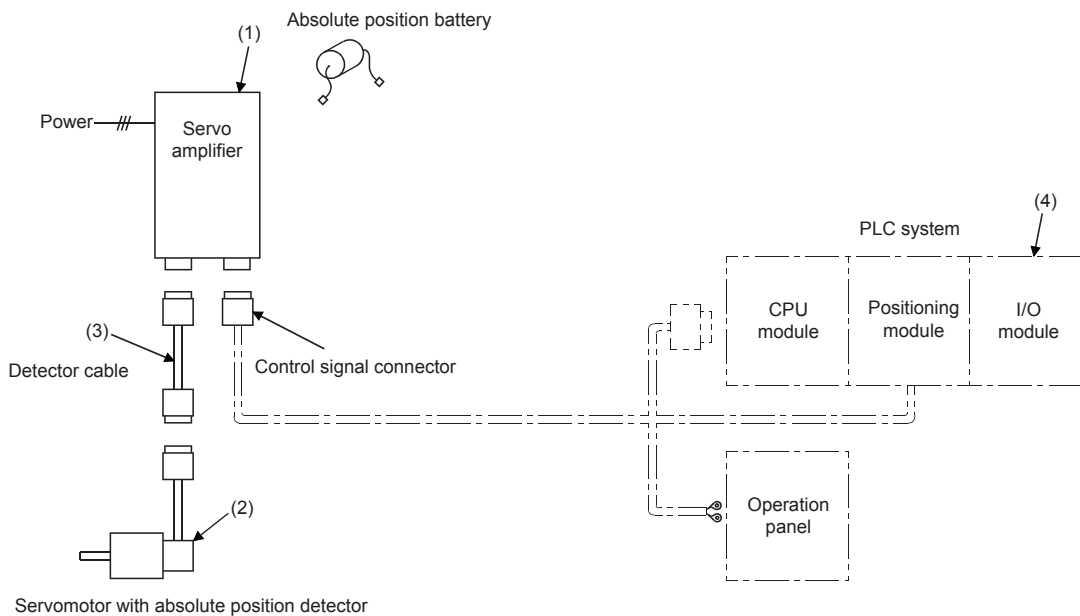

Preparation

Prepare the absolute position detection system with caution by referring to the following descriptions.

Component	Description
(1) Servo amplifier	<ul style="list-style-type: none"> Use a Mitsubishi General-Purpose AC Servo which has an absolute position detection function (absolute position data transfer protocol) equivalent to that of MR-J4-□A. Install the battery to the servo amplifier. Validate the absolute position detection function of the servo amplifier. For details, refer to the manual for the servo amplifier used.
(2) Servo motor	<ul style="list-style-type: none"> Use a servomotor with absolute position detector. For details, refer to the manual for the servo motor used.
(3) Encoder cable	<ul style="list-style-type: none"> Add a battery power connection cable (BAT/LG signal) to the incremental encoder cable connection. For details, refer to the manual for the cable used.
(4) PLC system	<ul style="list-style-type: none"> Establish the communications of absolute position detection data using a CPU module or I/O modules (three input points /three output points). Use CPU modules and I/O modules with any number of points. Allocating the three input signals in serial order facilitates the control with a program. This also applies to the three output signals.

Overview of the absolute position detection system

The detector comprises an encoder for the detection of position in one rotation in addition to the A, B, and Z phase signals for the position control in normal operation and an accumulative revolution counter for the detection of the number of rotations. The absolute position detection system detects the absolute position of the machine constantly and stores it with the backup of the battery irrespective of the state of the power supply to the PLC system. Therefore, once the OP initial setting is performed at the time of the installation of the machine, no OPR is required even when the power is turned on later. The restoration of the system can be performed easily even when an instantaneous power failure or an emergency stop occurs. In addition, because the absolute position data is backed up by a super capacitor in the detector, the absolute position data will be hold for a specified time even if a cable is disconnected or broken.

Transmission procedure for absolute position signal

The following figure shows the overview of the absolute position signal transmission procedure between a servo amplifier and a PLC system (CPU module, positioning module, and I/O modules). For details on the communication between the servo amplifier and PLC system, refer to the manual for the servo amplifier used.

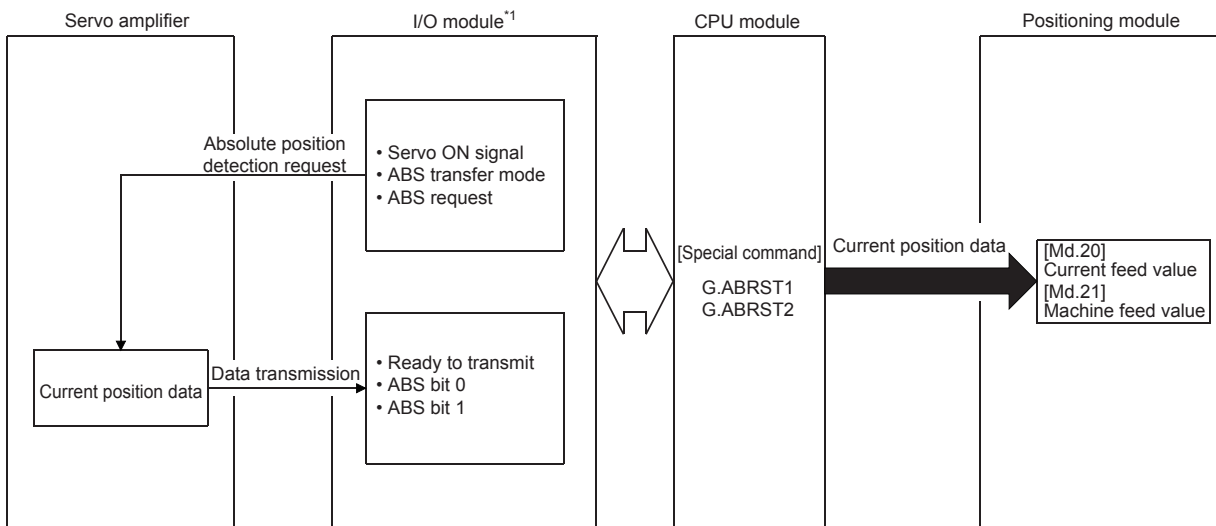

*1 CPU module input/output is also usable.

Errors during communication

- If a time-out occurs during communication, ABS transmission time out (Error code: 1949H) occurs.
- If transmission data causes a sum error, ABS transmission SUM (Error code: 194AH) occurs.

For corrective actions on errors, refer to the following.

📖 Page 524 List of Error Codes

Connection example

The following figure shows an example of the connection between the PLC system and the Mitsubishi Electric servo amplifier (MR-J4-A).

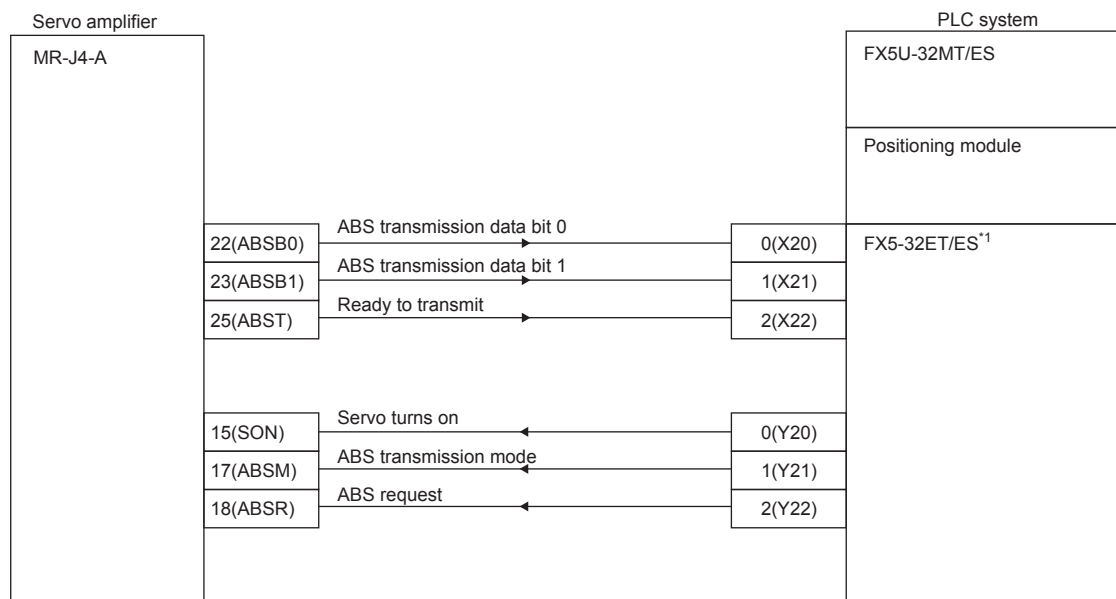

*1 X and Y devices can be configured as desired using programs.

The following table describes the pins used for setting the absolute position detection system.

Signal name	Abbreviation	Pin No.	Function and application
ABS transmission mode	ABSM	17 ^{*2}	While the ABSM is on, the servo amplifier is in the ABS transmission mode, and the CN1-22, 23, and 25 functions are as shown below in this table.
ABS request	ABSR	18 ^{*2}	The ABSR is turned on when ABS data is requested in the ABS transmission mode.
ABS transmission data bit 0	ABSB0	22	This signal indicates the lower bit of the two bits of ABS data to be transferred from the servo amplifier to the PLC system in the ABS transmission mode. The ABSB0 turns on when this signal occurs.
ABS transmission data bit 1	ABSB1	23	This signal indicates the upper bit of the two bits of ABS data to be transferred from the servo amplifier to the PLC system in the ABS transfer mode. The ABSB1 turns on when this signal occurs.
ABS transmission data ready	ABST	25	This signal indicates that the ABS transmission data is ready in the ABS transmission mode. When the data is ready, the ABST is turned on.

*2 When Use in the absolute position detection system is selected in the parameter No.PA03, the pin 17 is the ABS transmission mode (ABSM), and the pin 18 is the ABS request (ABSR). The signals do not return to the original signals even after the data transfer is completed.

For details on signals of the pin 17 and 18 while the ABS transmission mode is off and the input/output interface, refer to the manual for the servo amplifier (MR-J4-A).

Control precautions

- When an absolute position detection system is constructed, absolute position restoration must be performed at least once after the power supply is turned on or reset. Also, the servo amplifier does not servo on unless the absolute position restoration is completed.
- For an absolute position detection system, the OP shift function cannot be used together. If these functions are used together, positional deviation will occur.
- Limitless-feed controls exercised only in a fixed direction, such as the one using a turntable, cannot be performed.
- Positioning cannot be performed if the movement amount from the OP address exceeds the range of the conditions 1 and 2 shown in the restrictions on movement amounts. (☞ Page 274 Restrictions on movement amounts)

Restrictions on movement amounts

When performing the positioning in an absolute position detection system, use the system in a range which satisfies the following conditions 1 and 2.

In the range that does not satisfy the condition 1 and 2, positioning cannot be used in the absolute position detection system since the proper current value cannot be provided during the absolute position restoration.

Condition 1: Number of output pulses

This condition limits the number of pulses output from the positioning module to a servo amplifier when the positioning is performed with the OP 0 in the absolute position detection system. In the absolute position detection system, the number of pulses within the range determined by the following calculation formula can be output to the servo amplifier.

$$(-32767 \times \text{Encoder resolution}) \leq (\text{Number of output pulses}) \leq (32767 \times \text{Encoder resolution})$$

- Maximum rotation range: Zero point ± 32767 (rev)
- Encoder resolution: 8192 (pulse/rev), 16384 (pulse/rev)

The following table lists the number of output pulses for each detector resolution.

Encoder resolution	Number of output pulses
8192 pulse	-268427264 to 268427264 pulse
16384 pulse	-536854528 to 536854528 pulse

When the electronic gear of the servo amplifier is used, the electronic gear ratio must be considered. The actual range of the numbers of output pulses is determined by multiplying the range of the number of output pulses above by the inverse number of the electronic gear ratio.

Electronic gear ratio	Encoder resolution	Range of the numbers of output pulses
1/10 times	8192 pulse	-2684272640 to 2684272640 pulse
	16384 pulse	-5368545280 to 5368545280 pulse
20 times	8192 pulse	-13421363 to 13421363 pulse
	16384 pulse	-26842726 to 26842726 pulse

Condition 2: Positioning address

The following positioning addresses can be specified for the positioning module:

Unit setting	Range of positioning addresses
mm	-214748364.8 to 214748364.7 μ m
inch	-21474.83648 to 21474.83647inch
pulse	-2147483648 to 2147483647 pulse
degree	0 to 359.99999 $^{\circ}$

Example 1

Using the formula 1, this example calculates the positioning address which can be specified in the system with the OP address 214740000.0 (μ m).

- Expression 1: (Positioning address) = (Movement amount per pulse) \times (Number of output pulses) + (OP address)
- Condition

Item	Value
Movement amount per pulse	0.1 μ m
Encoder resolution	8192 pulse/rev

- Calculation of the upper limit value and lower limit value of positioning addresses

Upper limit value /lower limit value of positioning addresses	Range of positioning addresses
Upper limit value	$0.1 \times 268427264 + 214740000.0 = 241582726.4 \mu\text{m}$
Lower limit value	$0.1 \times (-268427264) + 214740000.0 = 187897273.6 \mu\text{m}$

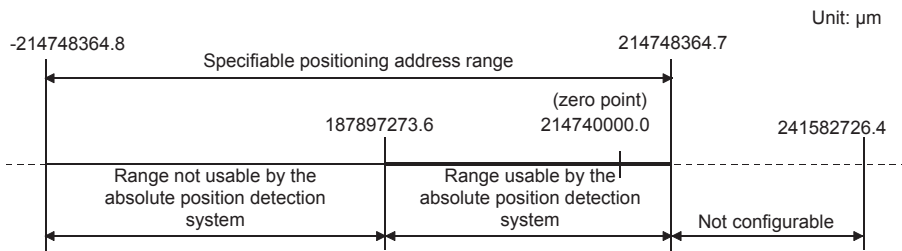

Example 2

This example shows the positioning address specification range that can be specified when degree is selected as the unit.

- In the absolute position detection system, the range of the available positioning addresses is from 0 $^{\circ}$ to 359.99999 $^{\circ}$, regardless of the OP address.
- For positioning in one direction, control from maximum to minimum (for address increase: 359.99999 $^{\circ}$ \rightarrow 0 $^{\circ}$ /for address decrease: 0 $^{\circ}$ \rightarrow 359.99999 $^{\circ}$) cannot be exercised.

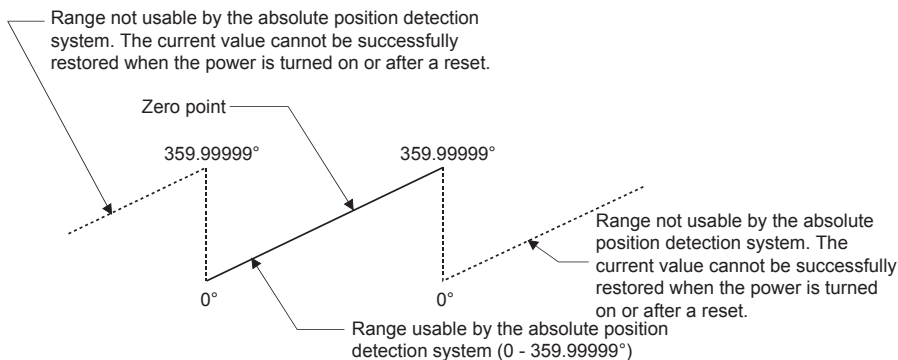

- Set the upper/lower limits of the software stroke limit to values between 0 $^{\circ}$ and 359.99999 $^{\circ}$ when using the absolute position detection system.

12.8 Function Related to Stop

As the functions related to stop, Stop command processing for deceleration stop function, Continuous operation interrupt function, and Step function are provided. Each function is executed by setting parameters or creating and writing a program.

Stop command processing for deceleration stop function

Stop command processing for deceleration stop function is provided to set the deceleration curve if a stop cause occurs during the deceleration stop processing (including automatic deceleration). This function is valid for both trapezoidal and S-curve acceleration/deceleration processing methods.

For details on the stop cause, refer to the following.

☞ Page 73 Stop processing

Stop command processing for deceleration stop function consists of the deceleration curve re-processing function and deceleration curve continuation function.

Control details

The following shows the operation of the stop command processing for deceleration stop function.

■Deceleration curve re-processing

A deceleration curve is re-processed starting from the speed at the stop cause occurrence to stop, according to the set deceleration time. If a stop cause occurs during the automatic deceleration of the position control, the deceleration stop processing stops as soon as the target has reached the positioning address specified in the positioning data currently being executed.

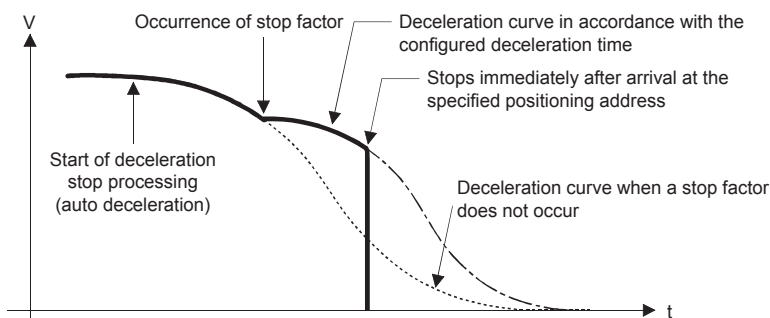

■Deceleration curve continuation

The current deceleration curve is maintained after the occurrence of a stop cause. If a stop cause occurs during the automatic deceleration of the position control, the deceleration stop processing may be completed before the target has reached the positioning address specified in the positioning data currently being executed.

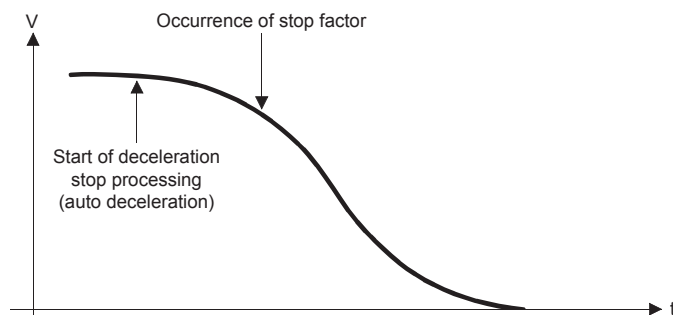

Control precautions

- In the manual control (JOG operation, inching operation, and manual pulse generator operation), the stop command processing for deceleration stop function is invalid.
- The stop command processing for deceleration stop function is valid when 0: Normal deceleration stop is set in [Pr.37] Stop group 1 sudden stop selection to [Pr.39] Stop group 3 sudden stop selection as the stopping method for the stop cause occurrence.
- The stop command processing for deceleration stop function is invalid when 1: Sudden stop is set in [Pr.37] Stop group 1 sudden stop selection to [Pr.39] Stop group 3 sudden stop selection. (A deceleration curve is reprocessed according to [Pr.36] Sudden stop deceleration time (starting from the speed at the stop cause occurrence to a stop).) In the position control (including the position control of the speed-position switching control and position-speed switching control), the positioning may stop immediately depending on the occurrence timing of the stop cause and the setting of [Pr.36] Sudden stop deceleration time.

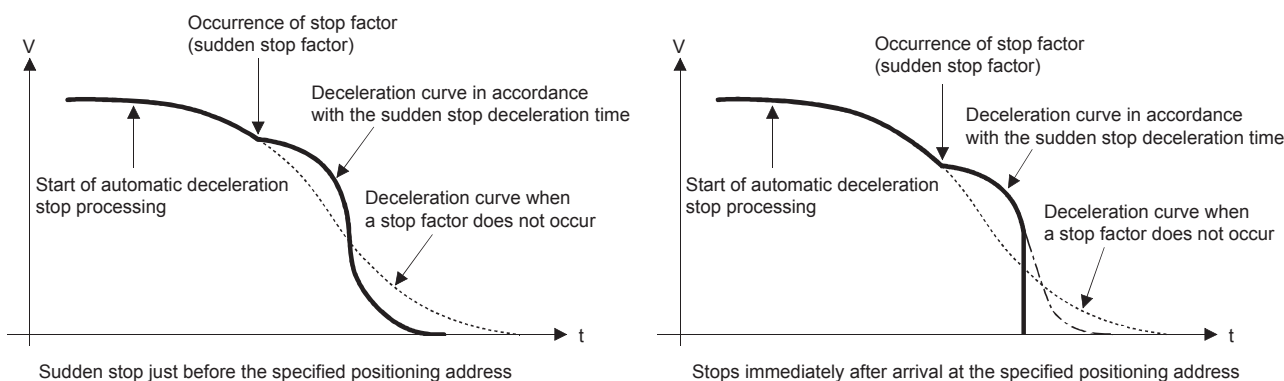

Setting method

To use the stop command processing for deceleration stop function, set the following control data in a program. The set data becomes valid as soon as they are written to the buffer memory. The status of [Cd.190] PLC READY signal is irrelevant.

Setting item		Setting value	Setting detail	Buffer memory address
[Cd.42]	Stop command processing for deceleration stop selection	→	Set the stop command processing for deceleration stop function. • 0: Deceleration curve re-processing • 1: Deceleration curve continuation	1907

For details on the settings, refer to the following.

☞ Page 467 [Cd.42] Stop command processing for deceleration stop selection

Continuous operation interrupt function

Continuous operation interrupt function can interrupt the positioning operations in the continuous positioning control and continuous path control. When the continuous operation is interrupted, the control will stop when the operation of the positioning data being executed is completed. To interrupt the continuous operation, set 1: Continuous operation interrupt request for [Cd.18] Continuous operation interrupt request.

In the continuous path control, the deceleration stop is performed according to the deceleration time set in [Da.4] Deceleration time No.

Operation when the continuous operation is interrupted

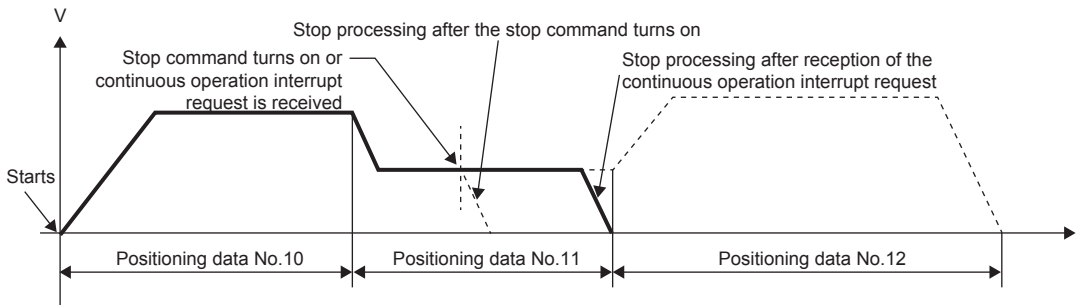

Restrictions

- When Continuous operation interrupt request is executed, the positioning will end. Thus, the operation cannot be restarted after the stop. If [Cd.6] Restart command is issued, Restart not possible (Warning code: 0902H) will occur.
- Even if a stop command is turned on after Continuous operation interrupt request is executed, the continuous operation interrupt request cannot be canceled. Thus, if the restart is executed after the stop is executed by turning on the stop command, the operation will stop when the positioning data No. where Continuous operation interrupt request was executed is completed.

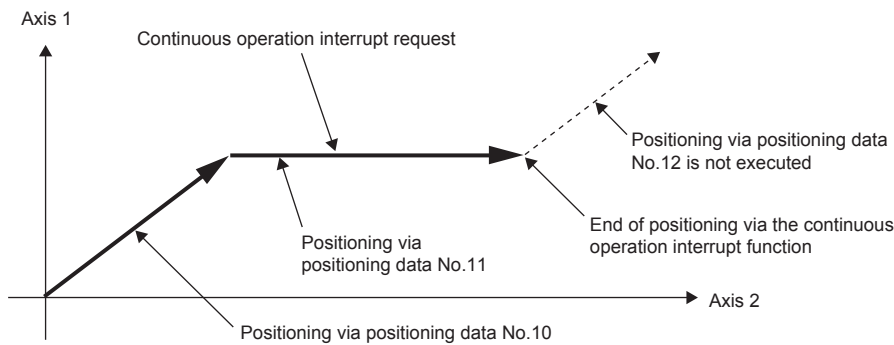

- If the operation cannot be decelerated to a stop because the remaining distance is insufficient when Continuous operation interrupt request is executed with the continuous path control, the interruption of the continuous operation will be postponed. The interruption is executed until the positioning data No. that secures a sufficient remaining distance, the positioning data No. set to positioning complete (pattern: 00), or the positioning data No. set to continuous positioning control (pattern: 01).

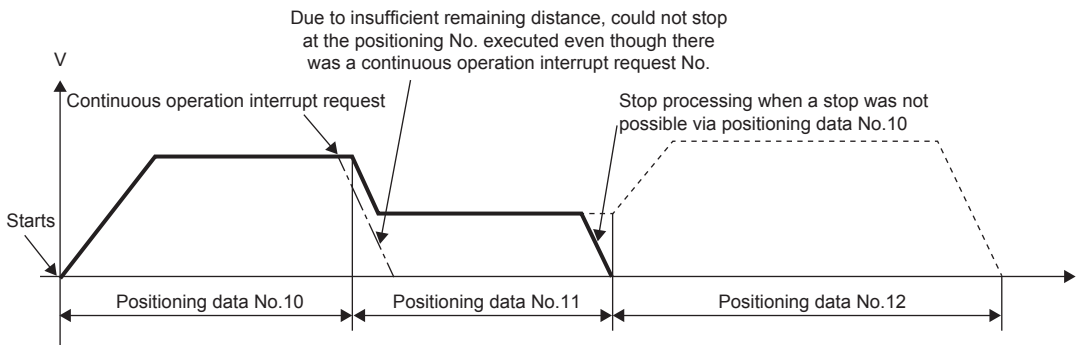

- When no operation is performed (when [Md.141] BUSY signal is off), the continuous operation interrupt request is not accepted. The request is cleared to 0 at a start or restart.

Control data requiring settings

Set the following data to interrupt the continuous operation.

Setting item		Setting value	Setting detail	Buffer memory address	
				Axis 1	Axis 2
[Cd.18]	Continuous operation interrupt request	1	Set 1: Continuous operation interrupt request.	1520	1620

For details on the settings, refer to the following.

📖 Page 475 [Cd.18] Continuous operation interrupt request

Step function

Step function is used to check each operation of the positioning control.

This function is used in debugging work for the major positioning controls.

The positioning operation in which the step function is used is called a step operation.

In step operations, the timing for stopping the control can be set. The setting is called the step mode. The control stopped by a step operation can be continued by using Step start request.

Relation between the step function and various controls

The following table shows the relation between Step function and various controls.

○: Set as required

×: Setting not possible

Control type		Step function	Step applicability	
OPR control	Machine OPR control	×	Step operation not possible	
	Fast OPR control	×		
Major positioning control	Position control	1-axis linear control	○	Step operation possible
		2-axis linear interpolation control	○	
		1-axis fixed-feed control	○	
		2-axis fixed-feed control	○	
		2-axis circular interpolation control	○	
	1/2-axis speed control	×	Step operation not possible	
	Speed-position switching control, Position-speed switching control	○	Step operation possible	
	Other controls	Current value change	○	Step operation not possible
JUMP instruction, NOP instruction LOOP to LEND		×		
Manual control	JOG operation, Inching operation	×	Step operation not possible	
	Manual pulse generator operation	×		

Step mode

In step operations, the timing for stopping the control can be set. The setting is called the step mode. (Step mode is set in the control data [Cd.34] Step mode.)

Step mode is classified into the following two types.

■Deceleration unit step

The operation stops at the positioning data requiring automatic deceleration. (A normal operation will be performed until the positioning data No. requiring automatic deceleration takes its turn. Once the turn comes, the positioning data will be executed, and the operation will automatically decelerate and stop.)

■Data No. unit step

The operation automatically decelerates and stops for each positioning data. (Even in the continuous path control, the automatic deceleration and the stop will be forcibly performed.)

Step start request

The control stopped by a step operation can be continued by using Step start request. (Step start request is set in the control data [Cd.36] Step start request.) Once accepted, the setting of [Cd.36] Step start request is automatically cleared.

The following table shows the results of starts using the step start request during the step operation.

Stop state in the step operation	[Md.26] Axis operation status	[Cd.36] Step start request	Result of step starts
The positioning of the step operation has normally stopped.	Step standby	1: Step continue	The next positioning data No. is performed.
The positioning of the step operation has not normally stopped. (due to stop signal or an error)	Stopped Error	1: Step continue	Step not possible (Warning code: 0996H)

Step not possible (Warning code: 0996H) will occur and the step operation will not be continued if [Md.26] Axis operation status is other than "-2: Step standby" or Step valid flag is off when the step start request is set.

Using the step operation

The following figure shows the procedure for checking positioning data in the step operation.

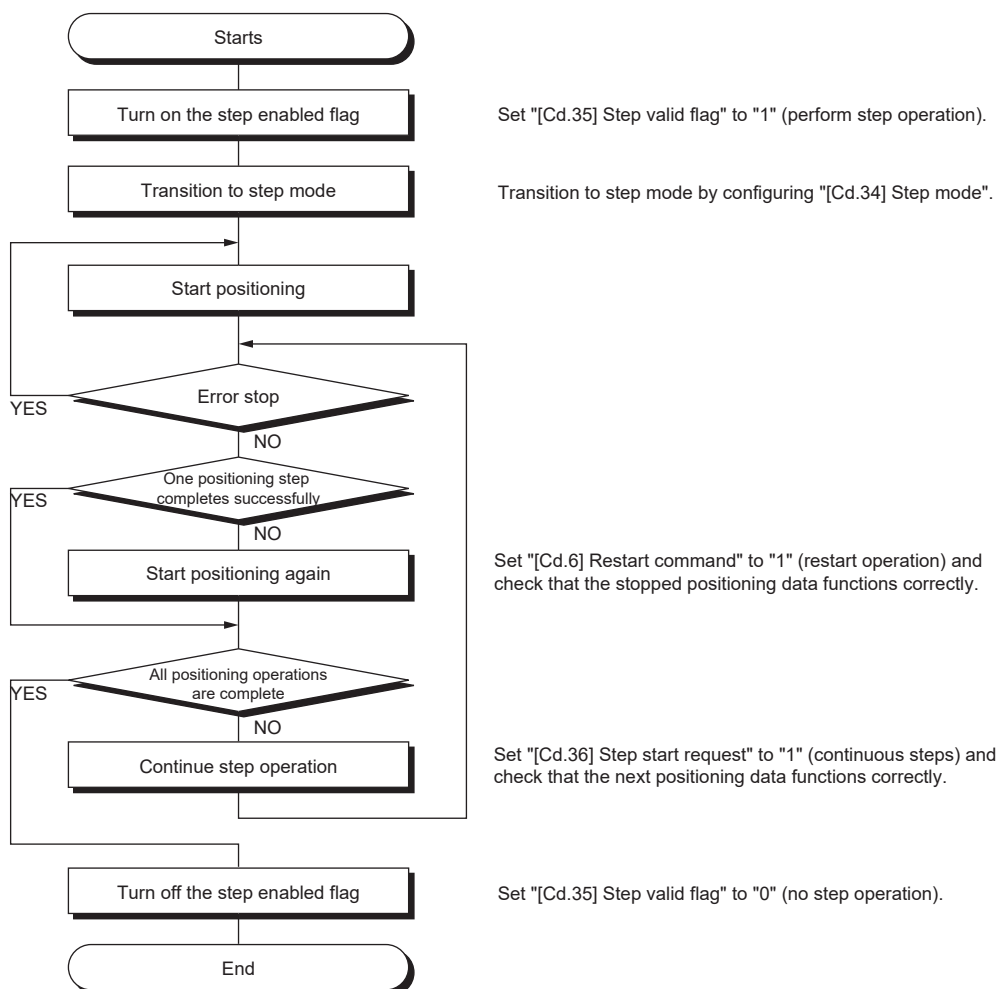

Control details

Deceleration unit step

The following figure shows a step operation during Deceleration unit step.

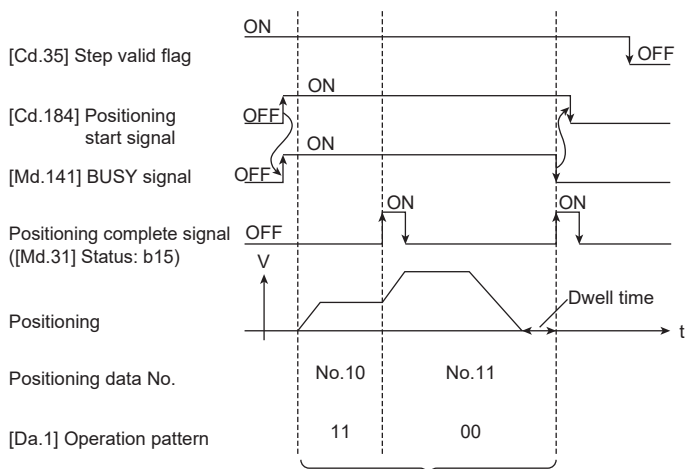

Positioning is performed in steps of automatic deceleration instead of positioning numbers.

Data No. unit step

The following figure shows a step operation during Data No. unit step.

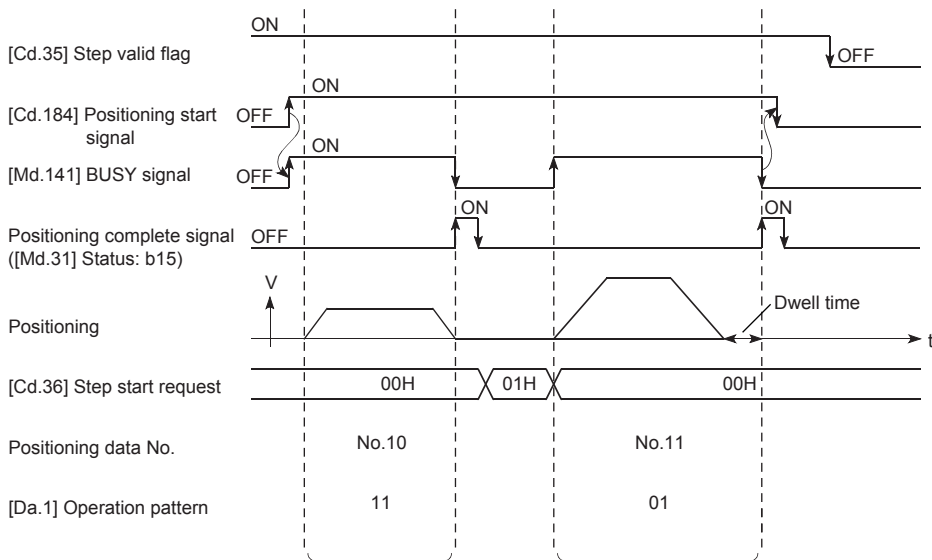

Positioning is performed in steps of positioning data numbers even when using the control (11) operation pattern.

Control precautions

- When a step operation is performed using the positioning data for the interpolation control, the step function settings are performed for the reference axis.
- When Positioning start signal is turned on while Step valid flag is on and [Md.26] Axis operation status is Step standby, the step operation will start from the beginning. (The step operation will be performed from the positioning data set in [Cd.3] Positioning start No.)

Setting the step function

To use the step function, set the following data into the positioning module using a program. For the setting timing, refer to  Page 281 Using the step operation refer to the following. The set data is validated when the data is written into the positioning module.

Setting item		Setting value	Setting detail	Buffer memory address	
				Axis 1	Axis 2
[Cd.34]	Step mode	→	Set either 0: Carry out step operation in deceleration units or 1: Carry out step operation in data No. units.	1544	1644
[Cd.35]	Step valid flag	1	Set 1: Carry out step operation.	1545	1645
[Cd.36]	Step start request	→	Set 1: Step continue, depending on the stop status.	1546	1646

For details on the settings, refer to the following.

 Page 479 [Cd.34] Step mode

 Page 479 [Cd.35] Step valid flag

 Page 480 [Cd.36] Step start request

12.9 Other Functions

As other functions, Skip function, M code output function, Teaching function, Command in-position function, Acceleration/ deceleration processing function, Deceleration start flag function, During uncompleted OPR operation setting function, and Interrupt function. Each function is executed by setting parameters or creating and writing a program.

Skip function

Skip function is used to perform the deceleration stop on the positioning data No. executed when Skip signal was input, and to execute the next positioning data No.

This function uses the positioning data for which "01: Continuous positioning control" or "11: Continuous path control" is set in [Da.1] Operation pattern during positioning.

Relation between the skip function and various controls

The following table shows the relation between Skip function and various controls.

- : Set as required
- ×: Setting not possible

Control type		Skip function	Skip operation applicability
OPR control	Machine OPR control	×	Skip operation not possible
	Fast OPR control	×	
Major positioning control	Position control	1-axis linear control	Skip operation possible
		2-axis linear interpolation control	
		1-axis fixed-feed control	
		2-axis fixed-feed control	
		2-axis circular interpolation control	
	1/2-axis speed control	×	Skip operation not possible
	Speed-position switching control	○	Skip operation possible
	Position-speed switching control	×	Skip operation not possible
	Other controls	Current value change	○
JUMP instruction, NOP instruction		×	Skip operation not possible
LOOP to LEND			
Manual control	JOG operation, Inching operation	×	Skip operation not possible
	Manual pulse generator operation	×	

Control details

The following figure shows the operation of the skip function.

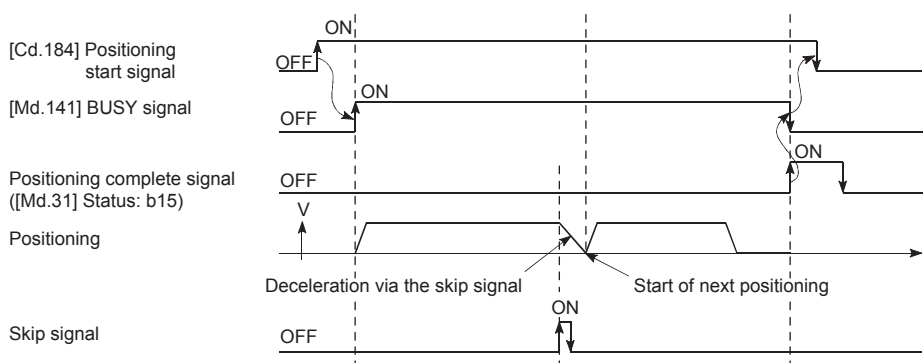

Control precautions

- When Skip signal is turned on during positioning of the positioning data for which Positioning complete is set in [Da.1] Operation pattern, the operation is completed after the deceleration stop.
- When the control is skipped (when Skip signal is turned on during the control), the Positioning complete signal ([Md.31] Status: b15) will not turn on.
- When Skip signal is turned on during the dwell time, the remaining time of the dwell time will be ignored, and the next positioning data will be executed.
- To skip a control during the interpolation control, turn on the skip signal of the reference axis. When the skip signal of the reference axis is turned on, the deceleration stop will be performed for every axis, and the next positioning data of the reference axis will be executed.
- M code ON signals ([Md.31] Status: b12) do not turn on when the M code output is set to the AFTER mode (When 1: AFTER mode is set in [Pr.18] M code ON signal output timing). (In this case, the M code will not be stored in [Md.25] Valid M code.)
- No positioning data can be skipped in the speed control and the position-speed switching control.
- If Skip signal is turned on while M code signal is on, the transition to the next data No. is not performed until M code signal is turned off.

Setting the function from the CPU module

The following shows a setting example and program example for skipping the control being executed in the axis 1 by a command sent from the CPU module.

■Setting data

Set the following data.

Setting item		Setting value	Setting detail	Buffer memory address	
				Axis 1	Axis 2
[Cd.37]	Skip command	1	Set 1: Skip request.	1547	1647

For details on the settings, refer to the following.

☞ Page 480 [Cd.37] Skip command

■Program example

Add the following program to the control program, and write it to the CPU module.

☞ Page 506 Skip program

Setting the function using an external command signal

The skip function can also be executed using an external command signal.

The section shows a setting example and program example for skipping the control being executed in the axis 1 using an external command signal.

■Setting data

Set the following data to execute the skip function using an external command signal.

Setting item		Setting value	Setting detail	Buffer memory address	
				Axis 1	Axis 2
[Pr.42]	External command function selection	3	Set 3: Skip request.	62	212
[Cd.8]	External command valid	1	Set 1: Validate external command.	1505	1605

For details on the settings, refer to the following.

☞ Page 412 [Pr.42] External command function selection

☞ Page 471 [Cd.8] External command valid

■Program example

Add the following program to the control program, and write it to the CPU module.

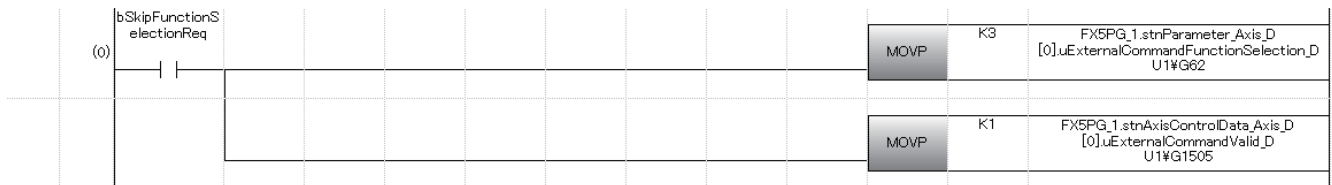

Classification	Label Name	Description		
Module label	FX5PG_1.stnParameter_Axis_D[0].uExternalCommandFunctionSelection_D	Axis 1 External command function selection		
	FX5PG_1.stnAxisControlData_Axis_D[0].uExternalCommandValid_D	Axis 1 External command valid		
Global label, local label	Define the global label or local label as follows. Setting Assign (Device/Label) for labels is not necessary because the unused internal relay and data device are automatically assigned to the labels.			
	97 bSkipFunctionSelectionReq	Bit		
	Label Name	Data Type	Class	Assign (Device/Label)
	...	VAR_GLOBAL		

M code output function

M code output function is used to command a subsidiary work (such as clamping, drilling, and tool replacement) related to the positioning data being executed.

When M code ON signal ([Md.31] Status: b12) turns on during positioning, a number called an M code is stored in [Md.25] Valid M code.

The value set in [Md.25] Valid M code is read from the CPU module, and used to command a subsidiary work. An M code can be set for each positioning data. (Set the M code in [Da.10] M code, one of the setting items of positioning data.)

Output timing of M code ON signal

M code output function can set the output (storage) timing of M codes. (The M code is stored in [Md.25] Valid M code when M code ON signal is turned on.)

The following two types of timing for outputting M codes are provided: WITH mode and AFTER mode.

WITH mode

M code ON signal ([Md.31] Status: b12) turns on at the positioning start, and an M code is stored in [Md.25] Valid M code.

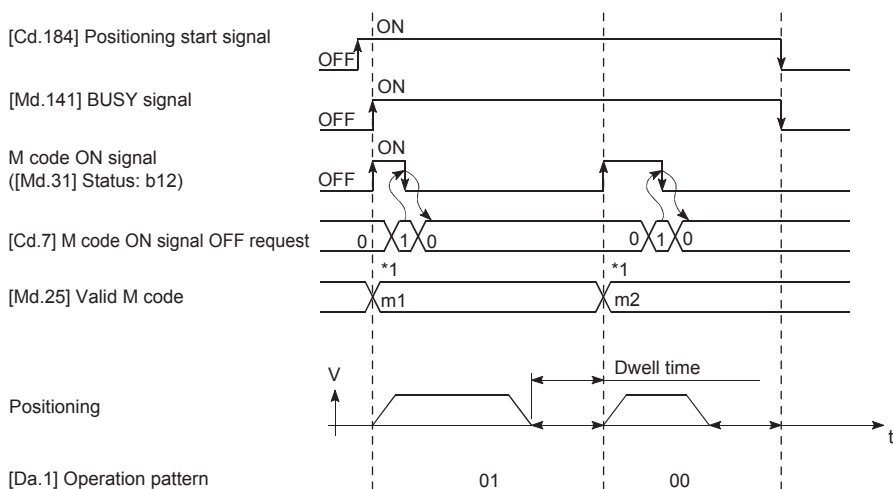

*1 m1 and m2 represent the configured M codes.

AFTER mode

M code ON signal ([Md.31] Status: b12) turns on at the completion of positioning, and an M code is stored in [Md.25] Valid M code.

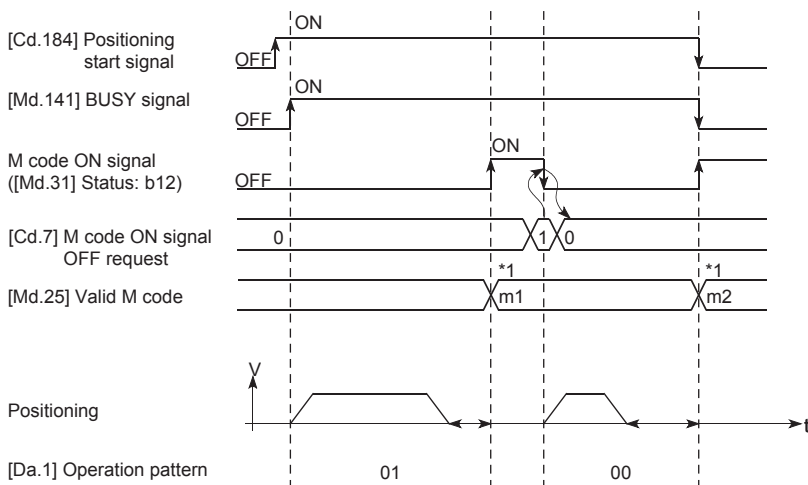

*1 m1 and m2 represent the configured M codes.

M code ON signal OFF request

When M code ON signal ([Md.31] Status: b12) turns on, the signal must be turned off by a program. To turn off M code ON signal, set 1 (M code ON signal is turned OFF) in [Cd.7] M code ON signal OFF request.

Setting item		Setting value	Setting detail	Buffer memory address	
				Axis 1	Axis 2
[Cd.7]	M code ON signal OFF request	1	Set 1: M code ON signal is turned OFF.	1504	1604

For details on the settings, refer to the following.

☞ Page 471 [Cd.7] M code ON signal OFF request

If M code ON signal is not turned off, the following processing will be performed. (The processing depends on the setting of [Da.1] Operation pattern.)

[Da.1] Operation pattern	Processing
00	Independent positioning control (positioning complete)
01	Continuous positioning control
11	Continuous path control

The next positioning data No. will not be executed until M code ON signal is turned off. (For 00 and 01)
 The next positioning data No. is performed. If an M code is set to the next positioning data, M code ON signal ON (Warning code: 0992H) will occur. (For 11)

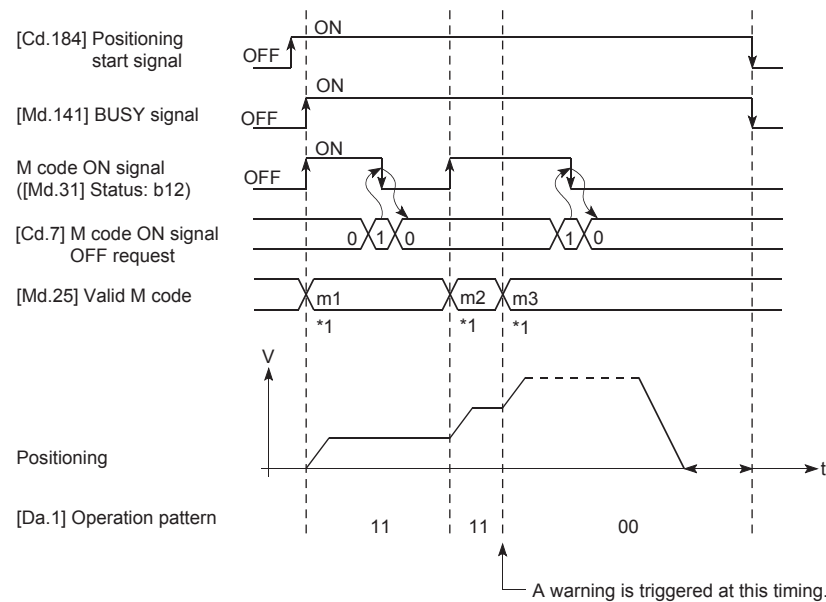

*1 m1 through m3 represent the configured M codes.

Point

If the M code output function is not required, set 0 in [Da.10] M code, one of the setting items of positioning data.

Control precautions

- During the interpolation control, M code ON signal of the reference axis is turned on.
- M code ON signal will not turn on if 0 is set in [Da.10] M code. The M code will not be output, and the previously output value will be held in [Md.25] Valid M code.)
- If M code ON signal is on at the positioning start, M code ON signal ON start (Error code: 19A0H) will occur, and the positioning will not start.
- If [Cd.190] PLC READY signal is turned off, M code ON signal will turn off and 0 will be stored in [Md.25] Valid M code.
- If the positioning operation time is short in the continuous path control, there will not be enough time to turn off M code ON signal, and M code ON signal ON (Warning code: 0992H) may occur. To avoid the warning, set 0 in [Da.10] M code of the positioning data in that section to prevent the M code from being output.
- When the AFTER mode is set in the speed control, the M code is not output and the M code ON signal is not turned on.
- If 9003 is set in [Cd.3] Positioning start No. and the current value change is performed, the M code output function is disabled.
- If two positioning data, one in the AFTER mode and the other in the WITH mode, are successively executed in the continuous path control, M code ON signal ON (Warning code: 0992H) occurs when the target data switches from the one in the AFTER mode to the one in the WITH mode. To avoid the warning, set 0 in [Da.10] M code of the positioning data in that section to prevent the M code from being output.

Setting method

The following shows the settings required for the M code output function.

■To specify the M code ON signal output timing separately for each positioning data

To specify the M code ON signal output timing separately for each positioning data, use "[Da.27] M code ON signal output timing".

The following settings are required to use the parameter.

- Set an M code number in [Da.10] M code, one of the setting items of positioning data.
- Set the timing to output an M code ON signal ([Md.31] Status: b12) in "[Da.27] M code ON signal output timing" of the positioning data.

■To specify the same M code ON signal output timing for all positioning data

Set "[Pr.18] M code ON signal output timing". The same M code ON signal output timing can be set for each positioning data in a batch. When "[Pr.18] M code ON signal output timing" is used, set 0 in "[Da.27] M code ON signal output timing". When a value other than 0 is set, "[Da.27] M code ON signal output timing" is enabled. (The setting of "[Pr.18] M code ON signal output timing" is validated at the rising edge (when turned off and on) of [Cd.190] PLC READY signal.)

The following settings are required to use the parameter.

- Set an M code number in [Da.10] M code, one of the setting items of positioning data.
- Set "0: Use the setting value in "[Pr.18] M code ON signal output timing"" (initial value) in "[Da.27] M code ON signal output timing" of the positioning data.
- Set the timing to output an M code ON signal ([Md.31] Status: b12) in the detailed parameter "[Pr.18] M code ON signal output timing".

■ Buffer memory to be used

Setting item		Setting value	Setting detail	Buffer memory address	
				Axis 1	Axis 2
[Pr.18]	M code ON signal output timing	→	Set the output timing of M code ON signal. • 0: WITH mode • 1: AFTER mode	27	177
[Da.27]	M code ON signal output timing	→	Set the M code ON signal output timing for each positioning data. • 0: Use the set value of "[Pr.18] M code ON signal output timing" • 1: WITH mode • 2: AFTER mode	2003+N*1 (b0 to b1)	8003+N*1 (b0 to b1)

*1 N indicates the offset address of each positioning data.
 $N = ((\text{Positioning data No.}) - 1) \times 10$

Reading M codes

An M code is stored in the following buffer memory address when M code ON signal turns on.

Monitor item		Monitor value	Monitor details	Buffer memory address	
				Axis 1	Axis 2
[Md.25]	Valid M code	→	Stores the M code number ([Da.10] M code) set in the positioning data.	808	908

For details on the stored contents, refer to the following.

☞ Page 455 [Md.25] Valid M code

■ Program example

The following shows a program example for reading [Md.25] Valid M code to the CPU module. Read M codes not as rising edge instructions but as ON execution instructions.



Classification	Label Name	Description
Module label	FX5PG_1.stnAxisMonitorData_Axis_D[0].uValidMcode_D	Axis 1 Valid M code
Global label, local label	Define the global label or local label as follows. Setting Assign (Device/Label) for labels is not necessary because the unused internal relay and data device are automatically assigned to the labels.	
	1 uValidMcode	Word [Unsigned]/Bit String [16-bit] ... VAR

Teaching function

Teaching function is used to set the address where the target is positioned using the manual control operation (JOG operation, inching operation, or manual pulse generator operation) in the positioning addresses ([Da.6] Positioning address/movement amount, [Da.7] Arc address).

Control details

■Teaching timing

Teaching is executed using a program while [Md.141] BUSY signal is off. (During a manual control operation, teaching can be performed even when an error or a warning occurs as long as the axis is not in the BUSY state.)

■Addresses for which teaching is possible

The target address for teaching is the current feed value ([Md.20] Current feed value) having the OP as a reference. The movement amount for positioning in the incremental system cannot be set. The teaching function sets the current feed value in [Da.6] Positioning address/movement amount or [Da.7] Arc address.

■Dedicated instruction GP.TEACH□

If the dedicated instruction GP.TEACH□, provided for the execution of the teaching function, is used, a program can be easily created. For details on the dedicated instructions, refer to the following.

📖 MELSEC iQ-F FX5 Programming Manual (Instructions, Standard Functions/Function Blocks)

Control precautions

- Before performing the teaching, Machine OPR must be performed to establish the OP. (When the current value change is performed, [Md.20] Current feed value may not show the absolute address having the OP as a reference.)
- Teaching cannot be performed for positions that cannot be targeted using the manual control (positions to which the workpiece cannot physically move). (During the operation that refers to a center point outside the moveable range such as the circular interpolation control operation with a center point specified, teaching cannot be performed for [Da.7] Arc address.)
- If an axis is in the BUSY state, the teaching cannot be performed to the axis.
- Written positioning data is stored in the buffer memory. Data in the buffer memory is cleared when the CPU module is powered off or reset. For this reason, it is recommended to register positioning data in the module extension parameter file of the CPU module or the positioning module by performing the module data backup when the positioning operation is normally completed.
- The number of module data backups using a program after the power is turned on once or the CPU module is reset is limited to up to 25 times (including the number of module data initializations). If the writing operation is executed 26th times, Flash ROM write number error (Error code: 1080H) will occur. If this error occurs, reset the error, power off and on the module again, or reset the CPU module.
- Writing to the flash ROM of the positioning module can be executed up to 100000 times. If the number of writing to the flash ROM exceeds 100000 times, writing data to the flash ROM may become impossible and Flash ROM write error (Error code: 1931H) will occur.

Data used in teaching

The following control data is used in teaching.

Setting item		Setting value	Setting detail	Buffer memory address	
				Axis 1	Axis 2
[Cd.1]	Module data backup request	1	Write the data in the buffer memory to a storage destination specified by the extension parameter storage setting. (Positioning data and block start data) <ul style="list-style-type: none"> • 0: Not requested • 1: Requested (After the data is written, 0 is automatically stored.) 	1900	
[Cd.38]	Teaching data selection	→	Set the write destination of Current feed value. <ul style="list-style-type: none"> • 0: Written to [Da.6] Positioning address/movement amount. • 1: Written to [Da.7] Arc address. 	1548	1648
[Cd.39]	Teaching positioning data No.	→	Specify the target data No. for teaching. (Teaching is performed when the set value is 1 to 600.) When the teaching has been completed, this data is cleared to 0.	1549	1649

For details on the settings, refer to the following.

☞ Page 466 [Cd.1] Module data backup request

☞ Page 480 [Cd.38] Teaching data selection

☞ Page 480 [Cd.39] Teaching positioning data No.

Teaching procedure

The following figure shows the procedure for the teaching operation.

■ Example 1

The following figure illustrates the process of teaching for [Da.6] Positioning address/movement amount (example with the axis 1).

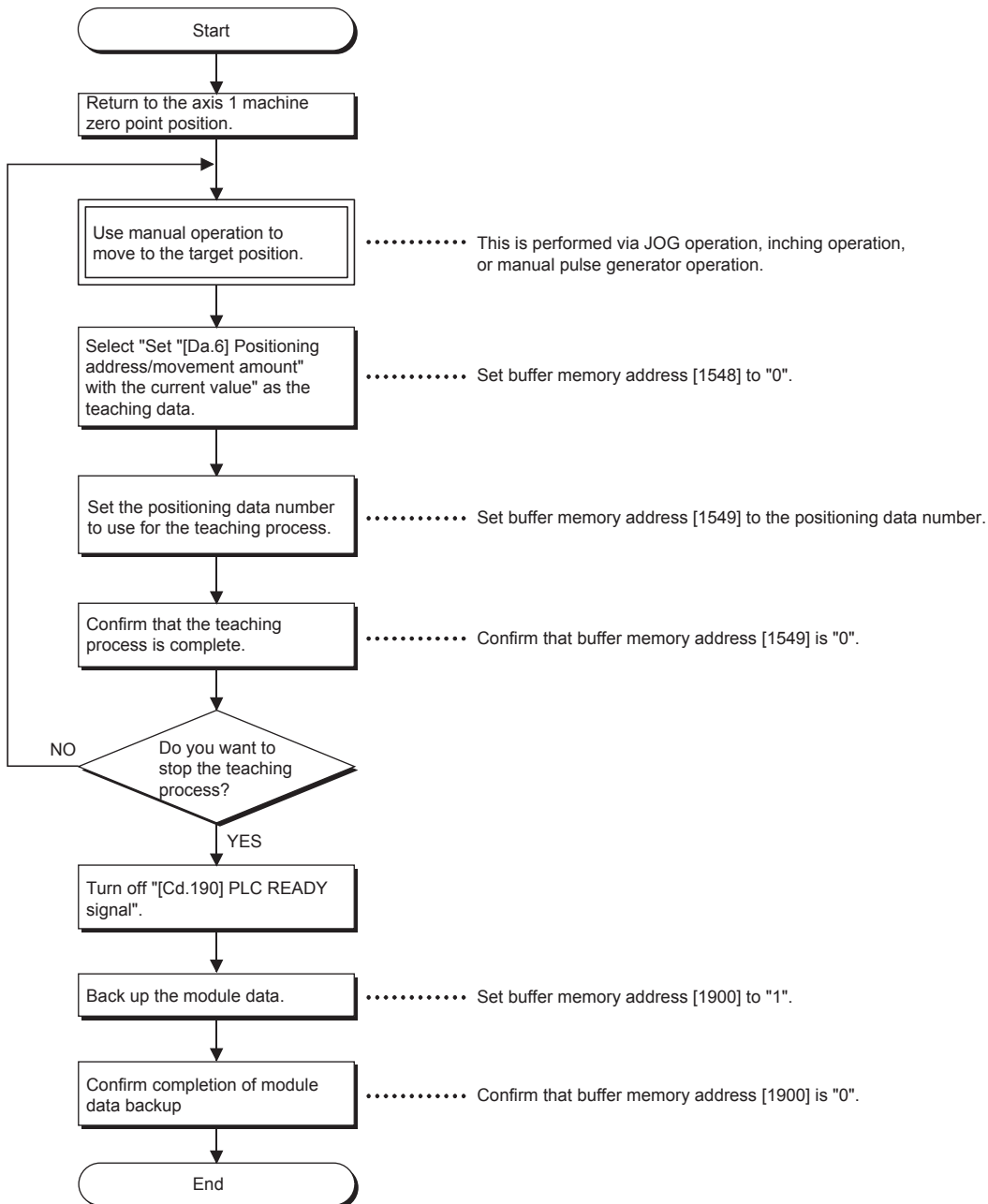

Example 2

The following figure illustrates the process of teaching for [Da.7] Arc address and then continuing onto [Da.6] Positioning address/movement amount (example for the 2-axis circular interpolation control with a sub point specified on the axis 1 and 2).

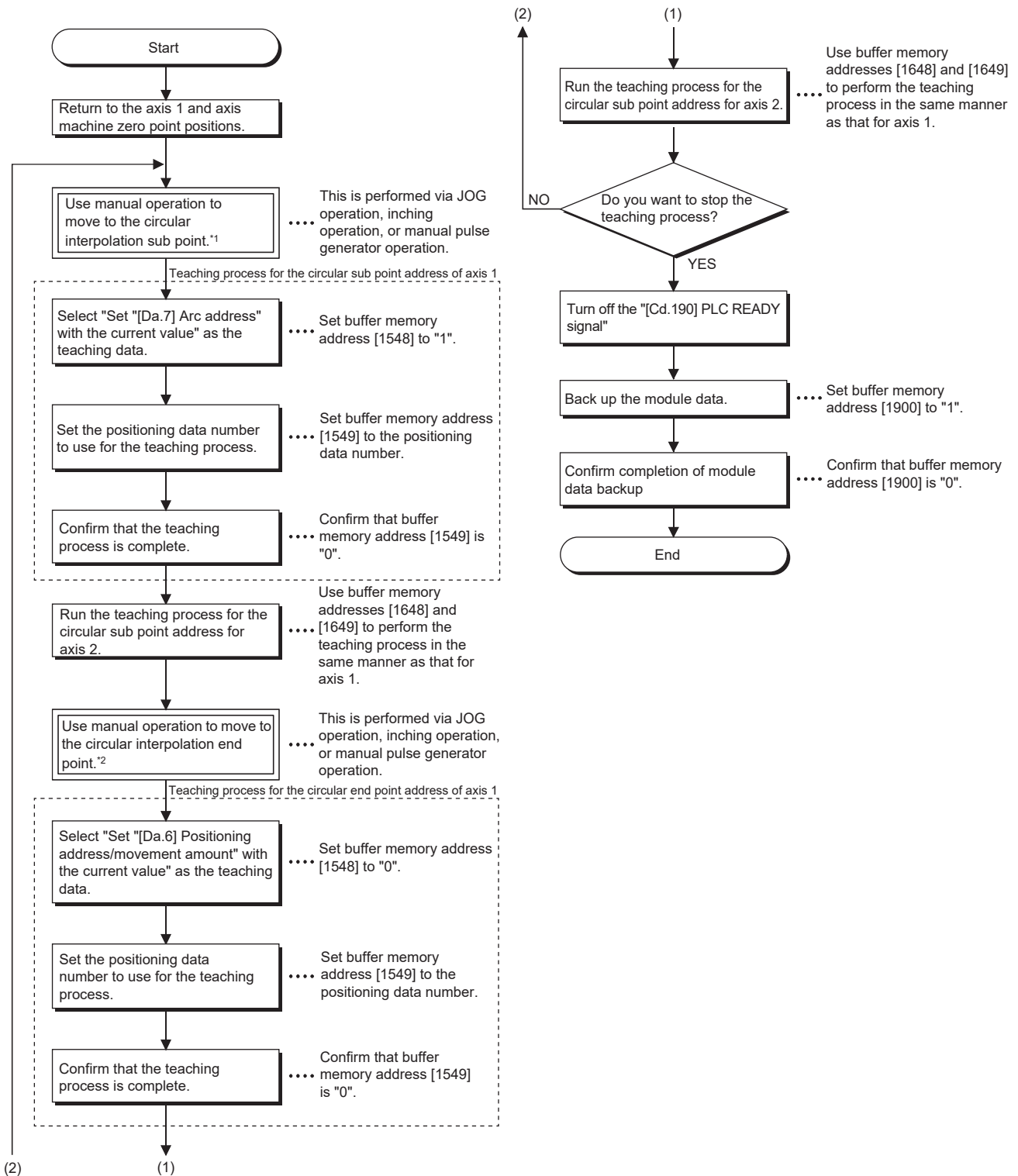

■ Operation chart

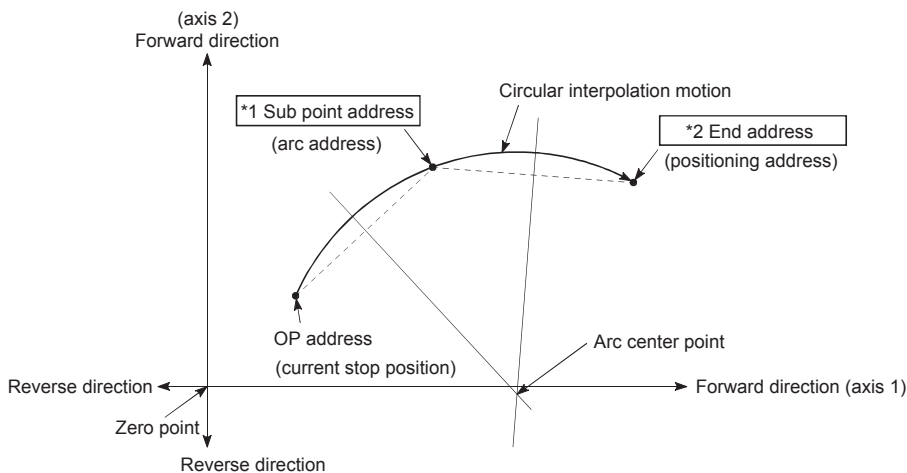

- *1 The sub point address is stored in Arc address.
- *2 The end point address is stored in Positioning address via teaching.

Program example for the teaching

The following shows a program example for setting (writing) the positioning data obtained by the teaching function in the positioning module.

■ Setting conditions

When setting the current feed value as a positioning address, write it while BUSY signal is off.

■ Program example

The following shows a program example to perform the teaching of the axis 1 using the dedicated instruction GP.TEACH1.

(1) Time chart

Move the workpiece to a target position using the JOG operation (inching operation or manual pulse generator operation).

[Example]

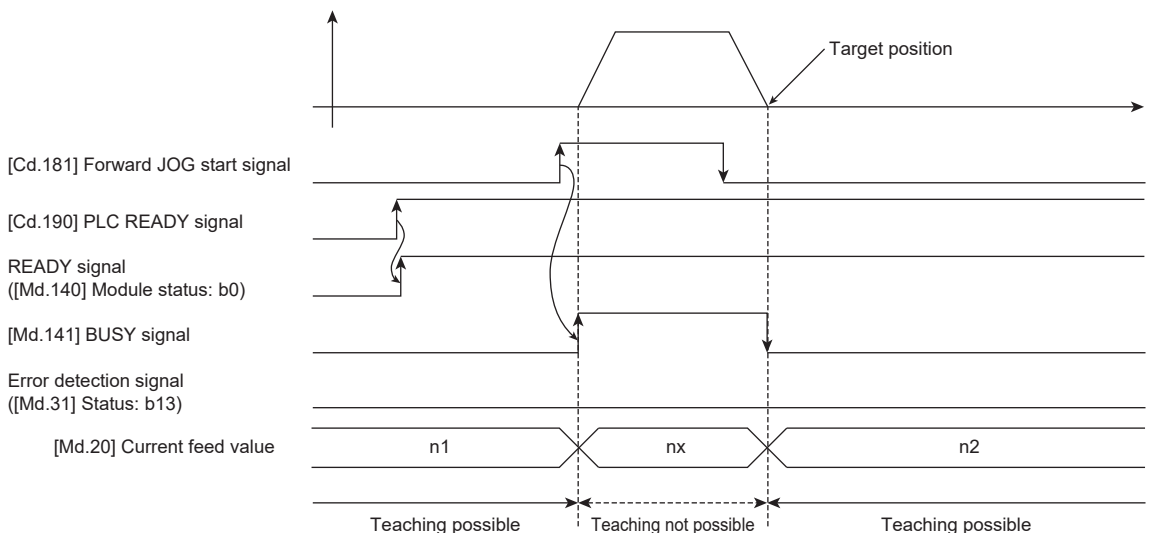

(2) Program example

Perform the teaching operation with the following program.

☞ Page 507 Teaching program

Point

- Before setting positioning data, check the teaching function and teaching procedure.
- The positioning addresses to be written are absolute address (ABS) values.
- When the positioning operation is normally completed with the written positioning data, registering the positioning data in the flash ROM of the positioning module is recommended.

Command in-position function

Command in-position function checks the remaining distance to the stop position during the automatic deceleration of the positioning control, and turns on the flag. This flag is called Command in-position flag. The command in-position flag is used as a front-loading signal indicating beforehand the completion of the position control.

Control details

The following shows the control details of the command in-position function.

- When the remaining distance to the stop position during the automatic deceleration of the position control becomes equal to or less than the value set in [Pr.16] Command in-position width, the Command in-position flag ([Md.31] Status: b2) is turned on.

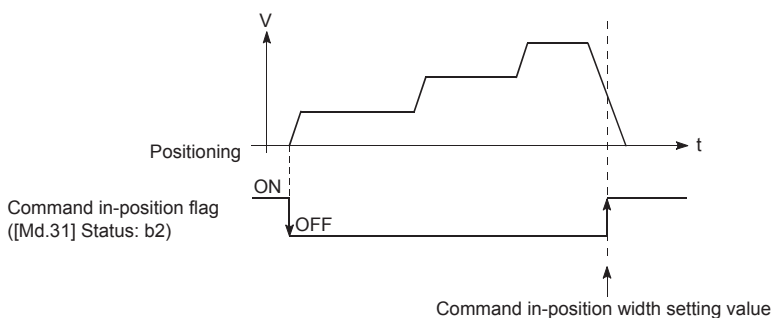

- The command in-position width check is performed every 0.88 ms.

Control precautions

- The command in-position width check will not be performed in the following cases.

Speed control

In speed control of the speed-position switching control

In speed control of the position-speed switching control

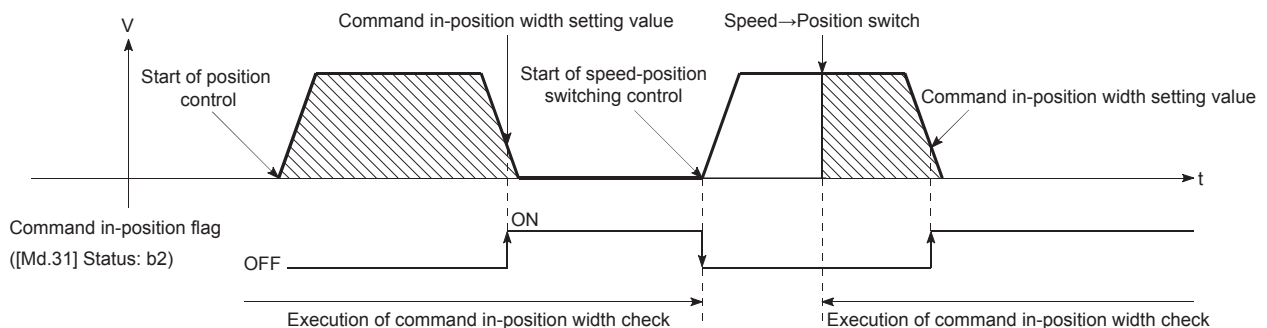

- Command in-position flag will be turned off in the following cases. (0 will be stored in [Md.31] Status: b2.)

At the position control start

At the speed control start

At the start of the speed-position switching control or position-speed switching control

At the OPR control start

At the JOG operation start

At the inching operation start

When the manual pulse generator operation is enabled

- [Pr.16] Command in-position width and Command in-position flag ([Md.31] Status: b2) of the reference axis are used during the interpolation control. When [Pr.20] Interpolation speed specification method is "0: Composite speed", the command in-position width check is performed in the remaining distance on the composite axis (line or arc connecting the start point address and end point address).

Setting method

To use the command in-position function, set the required value in the parameter shown in the following table, and write it to the positioning module. The settings are validated at the rising edge (when turned off and on) of [Cd.190] PLC READY signal.

Setting item		Setting value	Setting detail	Initial value at the factory	Buffer memory address	
					Axis 1	Axis 2
[Pr.16]	Command in-position width	→	Set the remaining distance to the stop position of the position control to turn on Command in-position flag.	100	24 25	174 175

For details on the settings, refer to the following.

 Page 398 [Pr.16] Command in-position width

Checking the status of Command in-position flag

The status of Command in-position flag is stored in the following buffer memory address.

Monitor item		Monitor value	Monitor details	Buffer memory address	
				Axis 1	Axis 2
[Md.31]	Status	→	Command in-position flag is stored in the b2 position.	817	917

For details on the stored contents, refer to the following.

 Page 458 [Md.31] Status

Point

- Parameters are set for each axis.
- Setting the parameters using GX Works3 is recommended. To perform the setting using programs, many programs and devices are required. The execution becomes complicated, and the scan times will increase.

Acceleration/deceleration processing function

Acceleration/deceleration processing function adjusts the acceleration/deceleration of each control to the acceleration/deceleration curve suited for the target device. Setting the acceleration/deceleration time changes the slope of the acceleration/deceleration curve. One of the following two methods can be selected for the acceleration/deceleration curve:

- Trapezoidal acceleration/deceleration
- S-curve acceleration/deceleration

Control details and setting of Acceleration/deceleration time 0 to 3

For the positioning module, four acceleration times and four deceleration times can be set. The different acceleration/deceleration times can be applied to the operations such as the positioning control, JOG operation, and OPR operation. Set the required values for the acceleration/deceleration times in the parameters shown in the following table, and write them to the positioning module. The set data is validated when the data is written into the positioning module.

Setting item		Setting value	Setting detail	Initial value at the factory	Buffer memory address	
					Axis 1	Axis 2
[Pr.9]	Acceleration time 0	→	Set an acceleration time within the range of 1 to 8388608 ms.	1000	12	162
					13	163
[Pr.25]	Acceleration time 1	→			36	186
					37	187
[Pr.26]	Acceleration time 2	→	Set a deceleration time within the range of 1 to 8388608 ms.	1000	38	188
					39	189
[Pr.27]	Acceleration time 3	→			40	190
					41	191
[Pr.10]	Deceleration time 0	→	Set a deceleration time within the range of 1 to 8388608 ms.	1000	14	164
					15	165
[Pr.28]	Deceleration time 1	→			42	192
					43	193
[Pr.29]	Deceleration time 2	→	1000	1000	44	194
					45	195
[Pr.30]	Deceleration time 3	→			46	196
					47	197

For details on the settings, refer to the following.

- ☞ Page 395 [Pr.9] Acceleration time 0, [Pr.10] Deceleration time 0
- ☞ Page 404 [Pr.25] Acceleration time 1 to [Pr.27] Acceleration time 3
- ☞ Page 404 [Pr.28] Deceleration time 1 to [Pr.30] Deceleration time 3

Control details and setting of Acceleration/deceleration method setting

In the acceleration/deceleration method setting, an acceleration/deceleration processing method is selected and set. The set acceleration/deceleration processing is applied to the acceleration/deceleration in all operations (excluding the inching operation and manual pulse generator operation). The following two acceleration/deceleration processing methods are provided.

■Trapezoidal acceleration/deceleration processing method

In this method, the linear acceleration/deceleration is performed based on the acceleration time, deceleration time, and speed limit value set by users.

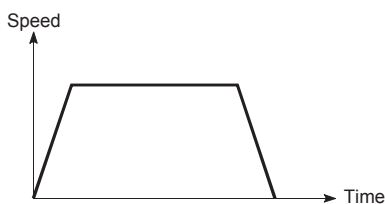

■S-curve acceleration/deceleration processing method

In this method, the motor burden at the start and stop is reduced.

The acceleration/deceleration is reduced gradually, based on the acceleration time, deceleration time, speed limit value, and the value set in [Pr.35] S-curve ratio (1 to 100%) set by users.

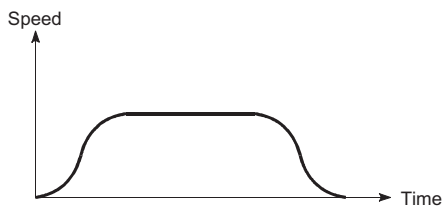

When an event that generates a speed change request occurs during the S-curve acceleration/deceleration processing (when a speed change request is given or Stop signal is turned on), the S-curve acceleration/deceleration processing begins at that point.

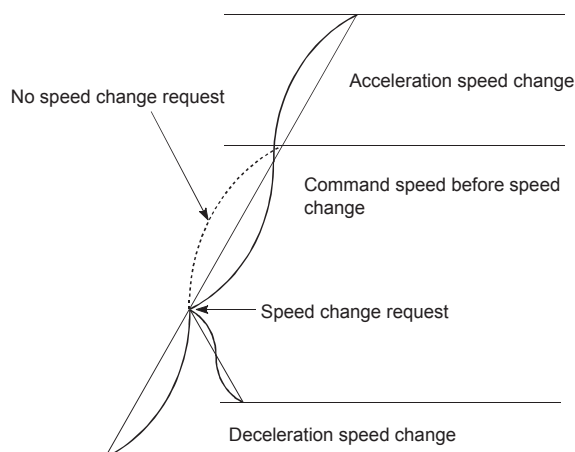

Set the required values for Acceleration/deceleration method setting in the parameter areas shown in the following table, and write them to the positioning module. The set data is validated when the data is written into the positioning module.

Setting item		Setting value	Setting detail	Initial value at the factory	Buffer memory address	
					Axis 1	Axis 2
[Pr.34]	Acceleration/deceleration processing selection	→	Set the acceleration/deceleration method. • 0: Trapezoidal acceleration/deceleration processing • 1: S-curve acceleration/deceleration processing	0	52	202
[Pr.35]	S-curve ratio	→	Set the acceleration/deceleration curve when 1 is set in [Pr.34] Acceleration/deceleration processing selection.	100	53	203

For details on the settings, refer to the following.

☞ Page 406 [Pr.34] Acceleration/deceleration processing selection

☞ Page 407 [Pr.35] S-curve ratio

Precautions

When a stepping motor is used, the acceleration increases around the inflection point in the S-shaped curved line compared with the trapezoidal acceleration/deceleration. This may cause step out. (When the trapezoidal acceleration/deceleration and S-curve acceleration/deceleration having the same acceleration/deceleration time are compared.)

In this case, adjust the acceleration/deceleration time so that the acceleration decreases around the inflection point, or use a servomotor.

Point

- Parameters are set for each axis.
- Setting the parameters using GX Works3 is recommended. To perform the setting using programs, many programs and devices are required. The execution becomes complicated, and the scan times will increase.

Deceleration start flag function

Deceleration start flag function turns on a flag when the speed is switched from the constant speed or acceleration to the deceleration during the position control whose operation pattern is Positioning complete. The flag can be used as a signal to start the operation to be performed by another device at every completion of the position control or to perform preparatory operation for the next position control.

Control details

When the deceleration stop is started in the position control whose operation pattern is Positioning complete, 1 is stored in [Md.48] Deceleration start flag. When the next operation starts or the manual pulse generator operation is enabled after the stop, 0 is stored.

Start made with the positioning data No. specified

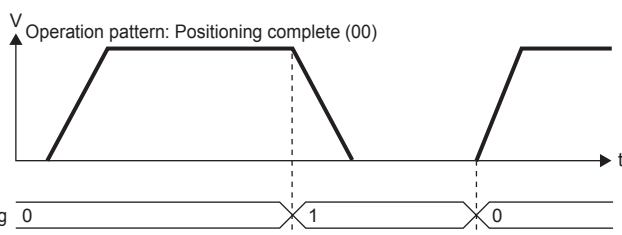

Block start

For the block start, this function is valid for only the position control whose operation pattern is Positioning complete at the point to which [Da.11] Shape is set to End.

The following table shows the operation of Deceleration start flag in the case when the following block start data and positioning data are used.

Block start data	[Da.11] Shape	[Da.12] Start data No.	[Da.13] Special start instruction
1st point	1: Continue	1	0: Block start
2nd point	1: Continue	3	0: Block start
3rd point	0: END	4	0: Block start
⋮			

Positioning data No.	[Da.1] Operation pattern	Corresponding block start data
1	01: Continuous positioning control	1st point
2	00: Positioning complete	—
3	00: Positioning complete	2nd point
4	11: Continuous path control	3rd point
5	00: Positioning complete	—
⋮		

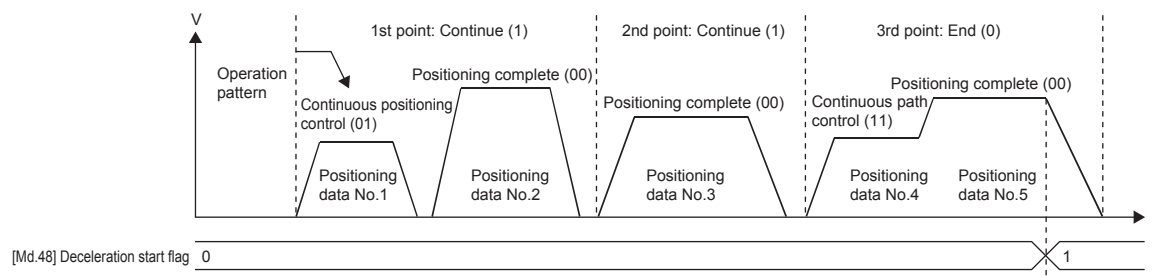

Control precautions

- The deceleration start flag function is valid for the control methods of 1-axis linear control, 2-axis linear interpolation control, speed-position switching control, and position-speed switching control. For the linear interpolation control, this function is valid only for the reference axis. (☞ Page 34 Combining Main and Sub Functions)
- The deceleration start flag does not turn on when the operation pattern is Continuous positioning control or Continuous path control.
- The deceleration start flag function is invalid for the OPR operation, JOG operation, inching operation, manual pulse generator operation, and during the deceleration by a stop signal.
- The deceleration start flag does not turn on when the deceleration is performed by the speed change or override.
- If the target position change is performed while Deceleration start flag is on, the deceleration start flag remains on.

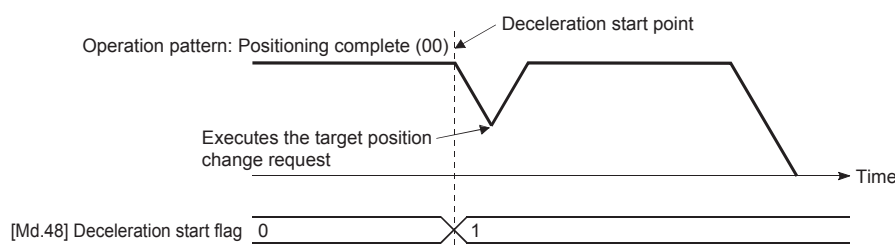

- When the movement direction is reversed by the target position change, the deceleration start flag turns on.

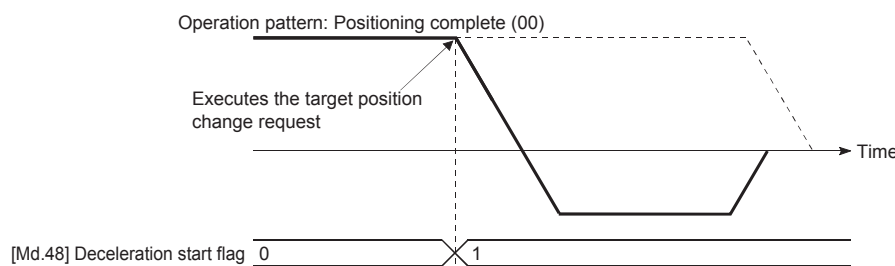

- During the position control of the position-speed switching control, Deceleration start flag is turned on by the automatic deceleration. Deceleration start flag remains ON if the control is switched to the speed control by Position-speed switching signal after Deceleration start flag has turned ON.
- If the condition start in a block start is not started since the condition is not satisfied, Deceleration start flag turns on as long as [Da.11] Shape is End.
- When a continuous operation interrupt request is issued, Deceleration start flag turns on at the start of the deceleration of the positioning data being executed.

Setting method

To use the deceleration start flag function, set 1 to the following control data using a program. The settings are validated at the rising edge (when turned off and on) of [Cd.190] PLC READY signal.

Setting item	Setting value	Setting detail	Buffer memory address
[Cd.41] Deceleration start flag valid	→	Set whether to enable or disable the deceleration start flag function. • 0: Deceleration start flag invalid • 1: Deceleration start flag valid	1905

For details on the settings, refer to the following.

☞ Page 467 [Cd.41] Deceleration start flag valid

Checking Deceleration start flag

The status of Deceleration start flag is stored in the following buffer memory address.

Monitor item		Monitor value	Monitor details	Buffer memory address	
				Axis 1	Axis 2
[Md.48]	Deceleration start flag	→	<ul style="list-style-type: none"> 0: Status other than below 1: Status from deceleration start to next operation start 	899	999

For details on the stored contents, refer to the following.

☞ Page 466 [Md.48] Deceleration start flag

During uncompleted OPR operation setting function

During uncompleted OPR operation setting function is used to select the positioning control performed when OPR request flag is on.

Control details

The following table shows the correspondence between positioning controls and the setting of [Pr.58] Setting of operation during uncompleted OPR to show whether the positioning start can be performed or not for each control.

Positioning control	[Pr.58] Setting of operation during uncompleted OPR	
	0: Do not execute the positioning control, and OPR request flag is on	1: Execute the positioning control, and OPR request flag is on
<ul style="list-style-type: none"> Machine OPR JOG operation Inching operation Manual pulse generator operation Current value change using the start for a current value change (9003) 1/2-axis speed control 	Positioning start not possible (cannot be executed)	Positioning start not possible (cannot be executed)
<ul style="list-style-type: none"> 1-axis linear control 2-axis linear interpolation control 1/2-axis fixed-feed control 2-axis circular interpolation control (sub point specification/ center point specification) Speed-position switching control (INC mode/ABS mode) Position-speed switching control Current value change using positioning data (No.1 to 600) 	Positioning start not possible (cannot be executed) Start error at OPR completion (Error code: 19A6H)	Positioning start not possible (cannot be executed)

Control precautions

Before starting the positioning while 0: Do not execute the positioning control is specified, turn off OPR request flag beforehand.

Setting method

To use the during uncompleted OPR operation setting function, write the following data into the positioning module using a program.

Setting item		Setting value	Setting detail	Buffer memory address	
				Axis 1	Axis 2
[Pr.58]	Setting of operation during uncompleted OPR	→	Set the operation during the OPR. <ul style="list-style-type: none"> 0: Do not execute the positioning control 1: Execute the positioning control 	90	240

Interrupt function

The interrupt function sends an interrupt request to the CPU module when an interrupt factor is detected. By using this function, an interrupt program can be started by detecting the occurrence of an interrupt factor such as the completion of the positioning. The positioning module can use 16 interrupt pointers at maximum.

Point

Using this function avoids the need to check buffer memory addresses periodically in a program. Therefore, this function can be applied to systems that need to switch controls in a short time.

The following processing can be performed.

- Executing an interrupt program for sub work at the instant when the remaining distance falls within a command in-position width. (using the command in-position flag is used as an interrupt factor)

Overview of the interrupt function

The positioning module has 16 interrupt settings and can execute 16 interrupt programs. The following shows the configurations of the data used for the interrupt function.

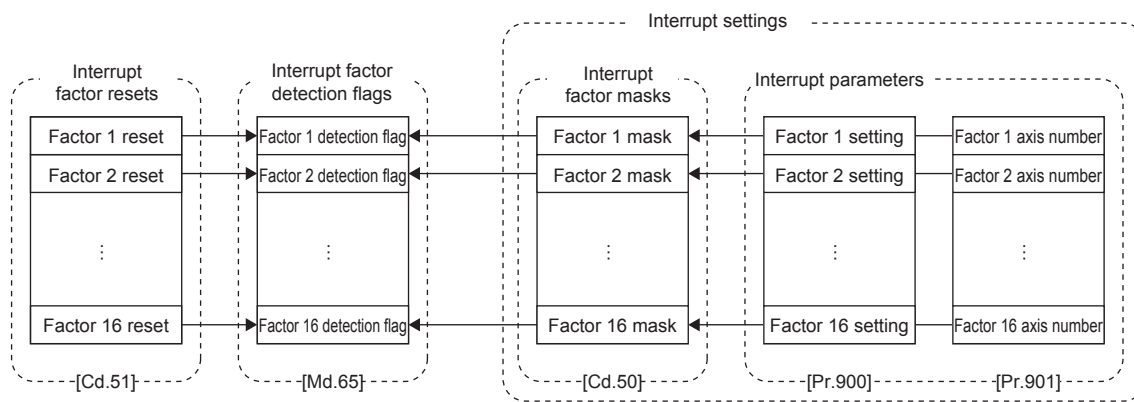

Beginning from the interrupt function setting, the following steps are made to use the interrupt function.

1. Set the interrupt parameters ([Pr.900] Interrupt factor setting and [Pr.901] Axis No. for interrupt factor) and write them to the positioning module.
2. Clear the mask by setting [Cd.50] Interrupt factor mask.
3. If the positioning module detects an interrupt factor, an interrupt request is sent to the CPU module and the corresponding interrupt program of the CPU module is executed.
4. Set 1: Interrupt factor reset request for [Cd.51] Interrupt factor reset request to clear the interrupt factor. The positioning module can detect a new interrupt factor after the old interrupt factor is cleared.

The interrupt function requires the following setting items.

Item		Buffer memory address			
		Setting 1	Setting 2	Setting n ^{*1}	Setting 16
[Md.65]	Interrupt factor detection flag	55000	55001	55000+n	55015
[Cd.50]	Interrupt factor mask	55064	55065	55064+n	55079
[Cd.51]	Interrupt factor reset request	55128	55129	55128+n	55143
[Pr.900]	Interrupt factor setting	55192	55193	55192+n	55207
[Pr.901]	Axis No. for interrupt factor	55256	55257	55256+n	55271

*1 n: 0 (setting 1) to 15 (setting 16)

Interrupt factor setting

To use the interrupt function, set the interrupt parameter. For the interrupt parameter, the setting value when [Cd.190] PLC READY signal is turned off and on is valid. After the power is switched on or the CPU module is reset, turn off and on [Cd.190] PLC READY signal.

■[Pr.900] Interrupt factor setting

Setting detail	Setting value	Detection timing	Buffer memory address ^{*1}
Set the target interrupt factor.	0: Do not detect	OFF → ON	55192+n
	1: M code ON ([Md.31] Status)		
	2: Error detection ([Md.31] Status)		
	3: [Md.141] BUSY		
	4: Start complete ([Md.31] Status)		
	5: Positioning complete ([Md.31] Status)	ON → OFF	
	100: Lower limit signal ([Md.30] External I/O signal)		
	101: Upper limit signal ([Md.30] External I/O signal)		
	102: Drive unit READY ([Md.30] External I/O signal)	OFF → ON	
	103: Stop signal ([Md.30] External I/O signal)		
	104: External command signal ([Md.30] External I/O signal)		
	105: Zero signal ([Md.30] External I/O signal)		
	106: Near-point dog signal ([Md.30] External I/O signal)		
	107: Deviation counter clear signal ([Md.30] External I/O signal)		
	200: In speed control flag ([Md.31] Status)		
	201: Speed-position switching latch flag ([Md.31] Status)		
	202: Command in-position flag ([Md.31] Status)		
	203: OPR request flag ([Md.31] Status)		
	204: OPR complete flag ([Md.31] Status)		
	205: Position-speed switching latch flag ([Md.31] Status)		
206: Warning detection ([Md.31] Status)			
207: Speed change 0 flag ([Md.31] Status)			
300: [Md.48] Deceleration start flag			
301: [Md.61] Analysis complete flag			

*1 n: 0 (setting 1) to 15 (setting 16)

■[Pr.901] Axis No. for interrupt factor

Setting detail	Setting value	Buffer memory address ^{*1}
[Pr.901] Axis No. for interrupt factor	Set the axis number for detecting the factor set in [Pr.900] Interrupt factor setting. • 0: All axes • 1: Axis 1 • 2: Axis 2	55256+n

*1 n: 0 (setting 1) to 15 (setting 16)

Detecting interrupt factors

To send an interrupt request to the CPU module when an interrupt factor is detected, clear the interrupt mask by setting [Cd.50] Interrupt factor mask beforehand.

Setting item	Setting value	Setting detail	Buffer memory address ^{*1}
[Cd.50] Interrupt factor mask	0, 1	Set the mask for the interrupt factor used. • 0: Mask (disable interruption) • 1: Clear mask (enable interruption)	55064+n

*1 n: 0 (setting 1) to 15 (setting 16)

If an interrupt factor occurs, the value in [Md.65] Interrupt factor detection flag changes as follows.

Monitor item		Monitor value	Monitor details	Buffer memory address ^{*2}
[Md.65]	Interrupt factor detection flag	0, 1	Stores the detecting status of an interrupt factor. • 0: Interrupt factor not detected • 1: Interrupt factor detected	55000+n

*2 n: 0 (setting 1) to 15 (setting 16)

Resetting interrupt factors

When [Cd.51] Interrupt factor reset request is set to 1: Reset request, the interrupt factor is reset and 0: Interrupt factor not detected is stored in [Md.65] Interrupt factor detection flag.

Setting item		Setting value	Setting detail	Buffer memory address ^{*1}
[Cd.51]	Interrupt factor reset request	0, 1	The interrupt factor is reset. • 0: No reset request • 1: Reset request When the interrupt factor reset request is accepted, 0 is stored.	55128+n

*1 n: 0 (setting 1) to 15 (setting 16)

The following figure shows an example of the interrupt factor reset processing.

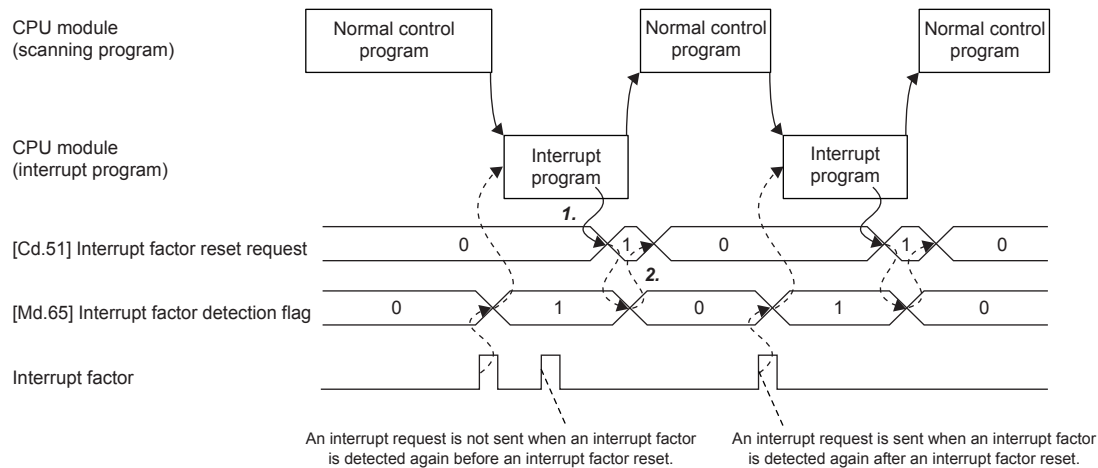

1. In the interrupt program, set [Cd.51] Interrupt factor reset request to 1: Reset request.
2. When [Cd.51] Interrupt factor reset request is accepted, [Md.65] Interrupt factor detection flag and [Cd.51] Interrupt factor reset request are cleared to 0.

Control precautions

- Even if the same interrupt factor occurs again while [Md.65] Interrupt factor detection flag is 1: Interrupt factor detected, no interrupt request is sent to the CPU module.
- While [Cd.50] Interrupt factor mask is 0: Mask, no interrupt request is sent to the CPU module.
- After the power is switched on or the CPU module is reset, no interrupt request is sent to the CPU module because the interrupt parameter in the positioning module is set to the initial value. Turn off and on [Cd.190] PLC READY signal to validate the interrupt parameter.
- Starting the "Positioning Test" in GX Works3 validates the interrupt parameter at a start.
- If a parameter error occurs when [Cd.190] PLC READY signal is turned off and on, or the "Positioning Test" in GX Works3 is started, the interrupt parameter is invalidated. No interrupt request is sent to the CPU module.

Operation example

The following shows an example of the interrupt factor setting and the operation in which the interrupt program of the interrupt pointer I50 is executed if the interrupt factor is detected.

Setting item		Setting value	Setting detail	Buffer memory address
[Pr.900]	Interrupt factor setting (setting 4)	202	202: Command in-position flag ([Md.31] Status)	55195
[Pr.901]	Axis No. for interrupt factor	1	1: Axis 1	55259

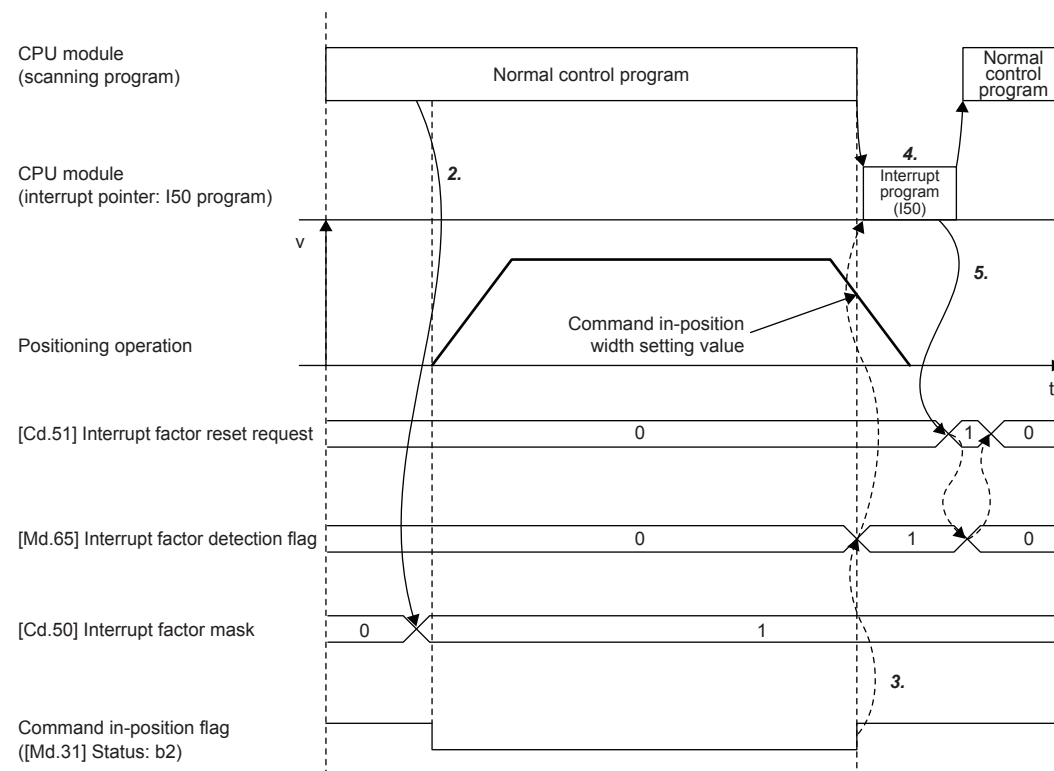

1. Configure the interrupt settings using GX Works3 and create the processing for Axis 1 command in-position in the I50 program. Write the project and validate the setting.
2. In the normal control program, set [Cd.50] Interrupt factor mask (address: 55067) to 1: Clear mask.
3. When the remaining distance of the axis 1 falls within the range specified by the command in-position width setting value, [Md.65] Interrupt factor detection flag (address: 55003) of setting 4 turns to 1: Interrupt factor detected at the same time when b2: Command in-position of [Md.31] Status turns on.
4. The interrupt pointer I50 program of the CPU module is started.
5. When the [Cd.51] Interrupt factor reset request (address: 55131) is set to "1: Reset request" in operation setting 4, the interrupt factor is cleared and 0: Interrupt factor not detected is stored in "[Md.65] Interrupt factor detection flag" (address: 55003) in operation setting 4.

For details on the interrupt pointer I50, refer to the following.

📖 MELSEC iQ-F FX5 User's Manual (Application)

Interrupt program example

The following figure shows a program example for the interrupt processing with Axis 1 command in-position shown in the operation example. (Page 306 Operation example)

Interrupt setting program

This program configures the following interrupt setting for the interrupt setting 1.

- Start an interrupt program by turning off and on Axis 1 command in-position. (This step is not required when the interrupt setting is configured in "Module Parameter").

The interrupt pointer setting is available only in GX Works3.

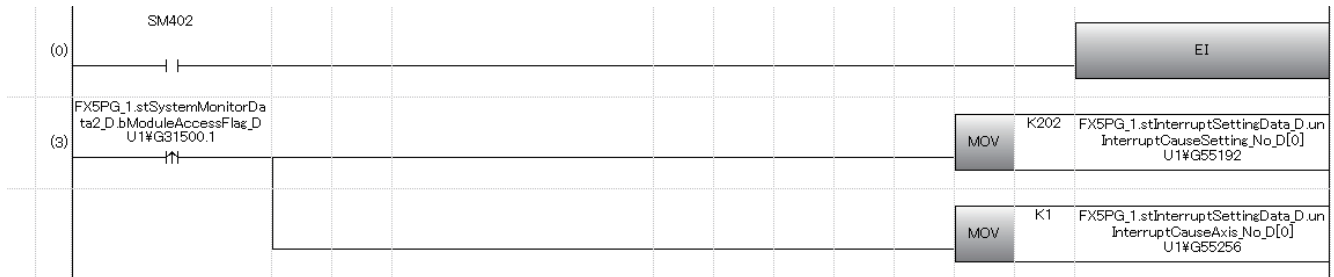

Classification	Label Name	Description
Module label	FX5PG_1.stSystemMonitorData2_D.bModuleAccessFlag_D	Module access flag
	FX5PG_1.stInterruptSettingData_D.unInterruptCauseSetting_No_D[0]	Interrupt setting No.1 [Pr.900] Interrupt factor setting
	FX5PG_1.stInterruptSettingData_D.unInterruptCauseAxis_No_D[0]	Interrupt setting No.1 [Pr.901] Axis No. for interrupt factor

Interrupt mask control program

This program sets or clears the interrupt mask of the interrupt setting 1.

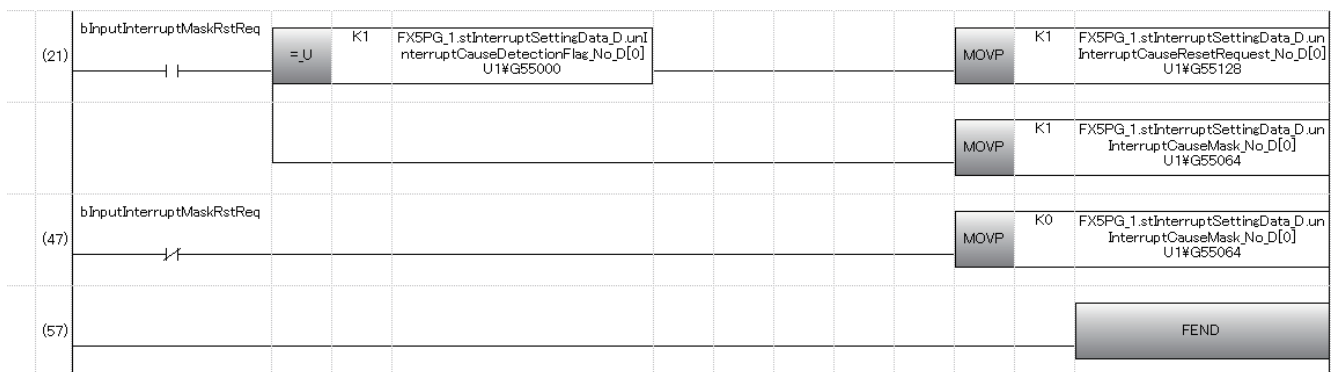

Classification	Label Name	Description		
Module label	FX5PG_1.stInterruptSettingData_D.unInterruptCauseDetectionFlag_No_D[0]	Interrupt setting No.1 [Md.65] Interrupt factor detection flag		
	FX5PG_1.stInterruptSettingData_D.unInterruptCauseResetRequest_No_D[0]	Interrupt setting No.1 [Cd.51] Interrupt factor reset request		
	FX5PG_1.stInterruptSettingData_D.unInterruptCauseMask_No_D[0]	Interrupt setting No.1 [Cd.50] Interrupt factor mask		
Global label, local label	Define the global label or local label as follows. Setting Assign (Device/Label) for labels is not necessary because the unused internal relay and data device are automatically assigned to the labels.			
	Label Name	Data Type	Class	Assign (Device/Label)
	96 bInputInterruptMaskRstReq	Bit	VAR_GLOBAL	

13 COMMON FUNCTIONS

This chapter describes the details and usage of the positioning module common functions executed according to the user's requirements.

Common functions include the functions required for using the positioning module such as the module data initialization function and module data backup function.

Check the setting and execution procedures for each common function, and execute an appropriate function as required.

13.1 Overview of Common Functions

Functions below referred to as Common function can be used as required regardless of the control method used. These common functions are executed with GX Works3 or programs.

The following table shows the functions included in the common functions.

Common function	Description
Module data initialization function	Sets module parameters and module extension parameters (positioning data and block start data) in the buffer memory and setting values in the module extension parameter file to their factory default settings.
Module Data Backup Function	Saves the module extension parameters (positioning data and block start data) in the buffer memory currently being used in control into the module extension parameter file.
External I/O Signal Logic Switching Function	Switches I/O signal logics according to the equipment connected to the positioning module. For the system in which signals handled as normally closed contacts (such as Drive unit READY signal and limit signals) are not used, the parameter logic setting can be controlled without wiring if the setting is changed to "Positive logic".
External I/O signal monitor function	Monitors External I/O signal using the module's detailed information which can be displayed on the system monitor page of GX Works3.
History Monitor Function	Monitors the error history, warning history, and start history of all axes.
Event history function	Stores the error occurred in the positioning module in the data memory of the CPU module or the SD memory card as events.
Amplifier-less operation function	Performs positioning controls without a drive unit. This function is used for debugging user programs at a start-up or simulating positioning operation.

13.2 Module Data Initialization Function

This function sets module parameters and module extension parameters (positioning data and block start data) in the buffer memory of the positioning module and setting values in the module extension parameter file to their factory default settings.

Module data initialization means

This function is executed with a program.

Control details

The following table lists the parameters that are initialized with the module data initialization function.

Parameter ^{*1}	Extension parameter storage setting ^{*2}	
	CPU module	Positioning module
Module parameter	The module parameters in the buffer memory are initialized.	
Module extension parameter	The module extension parameters in the buffer memory are initialized.	
	The module extension parameter file in the CPU module is initialized. ^{*3}	The module extension parameter file in the positioning module is initialized.

*1 For the parameter file, refer to the following.

☞ Page 487 Parameter Reflection

*2 The storage destination of module extension parameters is specified by the extension parameter storage setting. For details, refer to the following.

☞ Page 486 Extended parameter storage setting

*3 The module data initialization can be performed only while the CPU module status is STOP.

Control precautions

- Execute the module data initialization function only when the positioning control is not performed (when [Cd.190] PLC READY signal is off). If the initialization is executed while [Cd.190] PLC READY signal is on, PLC READY ON write (Warning code: 0905H) will occur.
- Writing to the flash ROM can be executed up to 100000 times. If the number of writing to the flash ROM exceeds 100000 times, writing data to the flash ROM may become impossible and Flash ROM write error (Error code: 1931H) will occur.
- After the parameter initialization is performed, powering off and on the system again or resetting the CPU module is required.
- If an error occurs in the set parameters of the positioning module while the [Cd.190] PLC READY signal is turned on, the READY signal ([Md.140] Module status: b0) will not turn on and control cannot be executed.
- The number of module data initializations using a program after the power is turned on once or the CPU module is reset is limited to up to 25 times (including the number of executions of the module data backup function). If the writing operation is executed 26th times, Flash ROM write number error (Error code: 1080H) will occur. If this error occurs, reset the error, power off and on the module again, or reset the CPU module.

Control restrictions

- When the extension parameter storage setting has been set to "CPU", the module data initialization can be performed only while the CPU module status is STOP. Use "[Cd.2] Module data initialization request" for the module data initialization.
- When the extension parameter storage setting has been set to "CPU", the initialized parameters become valid only after turning the power to the CPU module off and on again or by performing a reset. The CPU module cannot transition to the RUN state until the power to the CPU module is turned off and on again or a reset is performed.
- The module data initialization processing takes about 10 to 30 seconds. Do not turn on and off the power or reset the CPU module during the module data initialization processing. Doing so cancels the flash ROM write and the backed up data will be lost.

Module initialization method

The parameter initialization can be performed by writing the data shown in the table below into the positioning module buffer memory using the MOV instruction. The parameter initialization is executed at the timing when the data is written into the positioning module buffer memory.

Setting item		Setting value	Setting detail	Buffer memory address	
				Axis 1	Axis 2
[Cd.2]	Module data initialization request	1	<ul style="list-style-type: none"> • 0: Not requested • 1: Requested 	1901	

The module initialization can also be performed by using the GP.PINIT instruction of the dedicated instructions. For details on the dedicated instructions, refer to the following.

 MELSEC iQ-F FX5 Programming Manual (Instructions, Standard Functions/Function Blocks)

When the initialization is completed, "0" is set in "[Cd.2] Module data initialization request" automatically.

13.3 Module Data Backup Function

When buffer memory data is rewritten with programs or others, the setting values in the module extension parameter file and the execution data being used in control (buffer memory data) may differ. In cases like this, the execution data will be lost if the CPU module is powered off.

For the cases like this, the module data backup function writes the execution data into the module extension parameter file and backs up the data. The data in the module extension parameter file that was backed up will be written into the buffer memory when the power is turned on next time.

Module backing up means

This function is executed with a program.

Control details

The following table lists the data that can be backed up with the module data backup function.

Parameter ^{*1}	Extension parameter storage setting ^{*2}	
	CPU module	Positioning module
Module parameter	No data is backed up.	
Module extension parameter	The module extension parameters in the buffer memory are backed up in the module extension parameter file of the CPU module. ^{*3}	The module extension parameters in the buffer memory are backed up in the module extension parameter file of the positioning module.

*1 For the parameter file, refer to the following.

 Page 487 Parameter Reflection

*2 The storage destination of module extension parameters is specified by the extension parameter storage setting. For details, refer to the following.

 Page 486 Extended parameter storage setting

*3 The module data backup can be performed only while the CPU module status is STOP.

Control precautions

- Write data into the flash ROM only when the positioning control is not performed (when [Cd.190] PLC READY signal is off). If the initialization is executed while [Cd.190] PLC READY signal is on, PLC READY ON write (Warning code: 0905H) will occur.
- Writing to the flash ROM can be executed up to 100000 times. If the number of writing to the flash ROM exceeds 100000 times, writing data to the flash ROM may become impossible and Flash ROM write error (Error code: 1931H) will occur.
- The number of module data backups using a program after the power is turned on once or the CPU module is reset is limited to up to 25 times (including the number of executions of the module data initialization function). If the writing operation is executed 26 times, Flash ROM write number error (Error code: 1080H) will occur. If this error occurs, reset the error, power off and on the module again, or reset the CPU module.

Control restrictions

- When the extension parameter storage setting has been set to "CPU", the module data backup can be performed only while the CPU module status is STOP. Use "[Cd.1] Module data backup request" for the module data backup.
- When the extension parameter storage setting has been set to "CPU", the backed up parameters become valid only after turning the power to the CPU module off and on again or by performing a reset. The CPU module cannot transition to the RUN state until the power to the CPU module is turned off and on again or a reset is performed.
- Do not turn on and off the power or reset the CPU module during the writing processing to the flash ROM. Doing so cancels the flash ROM write and the backed up data will be lost.

Module backing up method

The module backing up operation can be performed by writing the data shown in the table below into the positioning module buffer memory using the TO instruction. The module data backup operation is executed at the timing when the data is written into the positioning module.

Setting item		Setting value	Setting detail	Buffer memory address	
				Axis 1	Axis 2
[Cd.1]	Module data backup request	1	<ul style="list-style-type: none">• 0: Not requested• 1: Requested	1900	

The module backup can also be performed by using the GP.PFWRT instruction of the dedicated instructions. For details on the dedicated instructions, refer to the following.

 MELSEC iQ-F FX5 Programming Manual (Instructions, Standard Functions/Function Blocks)

When the data has been written to the flash ROM, "0" is set in "[Cd.1] Module data backup request" automatically.

13.4 External I/O Signal Logic Switching Function

This function switches the signal logics according to the external device connected to the positioning module.

For the system in which Drive unit READY signal handled as a normally closed contact, upper limit switch, and lower limit switch are not used, controlling can be performed by this function without wiring if the parameter logic setting is changed to Positive logic.

When Drive unit READY signal, upper limit switch, and lower limit switch are used, ensure to use them as normally closed contacts.

Parameter setting details

To use the external I/O signal logic switching function, set the parameters shown in the following table.

Setting item		Setting detail		Initial value at the factory	Buffer memory address		
					Axis 1	Axis 2	
[Pr.22]	Input signal logic selection	Set the logic of each input signal according to the external device.		0	31	181	
		b0	Lower limit signal				<ul style="list-style-type: none"> • 0: Negative logic • 1: Positive logic
		b1	Upper limit signal				
		b2	Drive unit READY signal				
		b3	Stop signal				
		b4	External command signal				
		b5	Zero signal				
		b6	Near-point dog signal				
		b7	Use prohibited				Set 0.
		b8	Manual pulse generator input				<ul style="list-style-type: none"> • 0: Negative logic • 1: Positive logic
b9 to b15	Use prohibited	Set 0.					
[Pr.23]	Output signal logic selection	Set the logic of each output signal according to the external device.		0	32	182	
		b0	Command pulse signal				<ul style="list-style-type: none"> • 0: Negative logic • 1: Positive logic
		b1 to b3	Use prohibited				Set 0.
		b4	Deviation counter clear signal				<ul style="list-style-type: none"> • 0: Negative logic • 1: Positive logic
		b5 to b15	Use prohibited				Set 0.

Precautions on the parameter setting

- The parameters for the external I/O signal logic switching function become valid at the timing when [Cd.190] PLC READY signal is turned off and on. (The logic is negative right after the power is turned on.)
- If the logic of each signal is set incorrectly, the operation may not be performed properly. Before setting logics, check the specifications of the device used.

13.5 External I/O Signal Monitor Function

External I/O signal monitor function monitors the module information on the engineering tool. The following shows the information that can be monitored.

- RUN LED, ERROR LED
- No. of write accesses to flash ROM (the same information as "[Md.19] No. of write accesses to flash ROM")
- External I/O signal (The logics of the external I/O signals are set in "[Pr.22] Input signal logic selection" and "[Pr.23] Output signal logic selection".)

Point

For the supported positioning module version to use the external I/O signal monitor function, refer to Page 561 Added and Enhanced Functions.

Operation method

Display [Module Information List] by following the procedure shown below.

[Diagnostics]⇒[System Monitor]⇒Double-click "FX5-20PG-□"⇒[Module Information List]

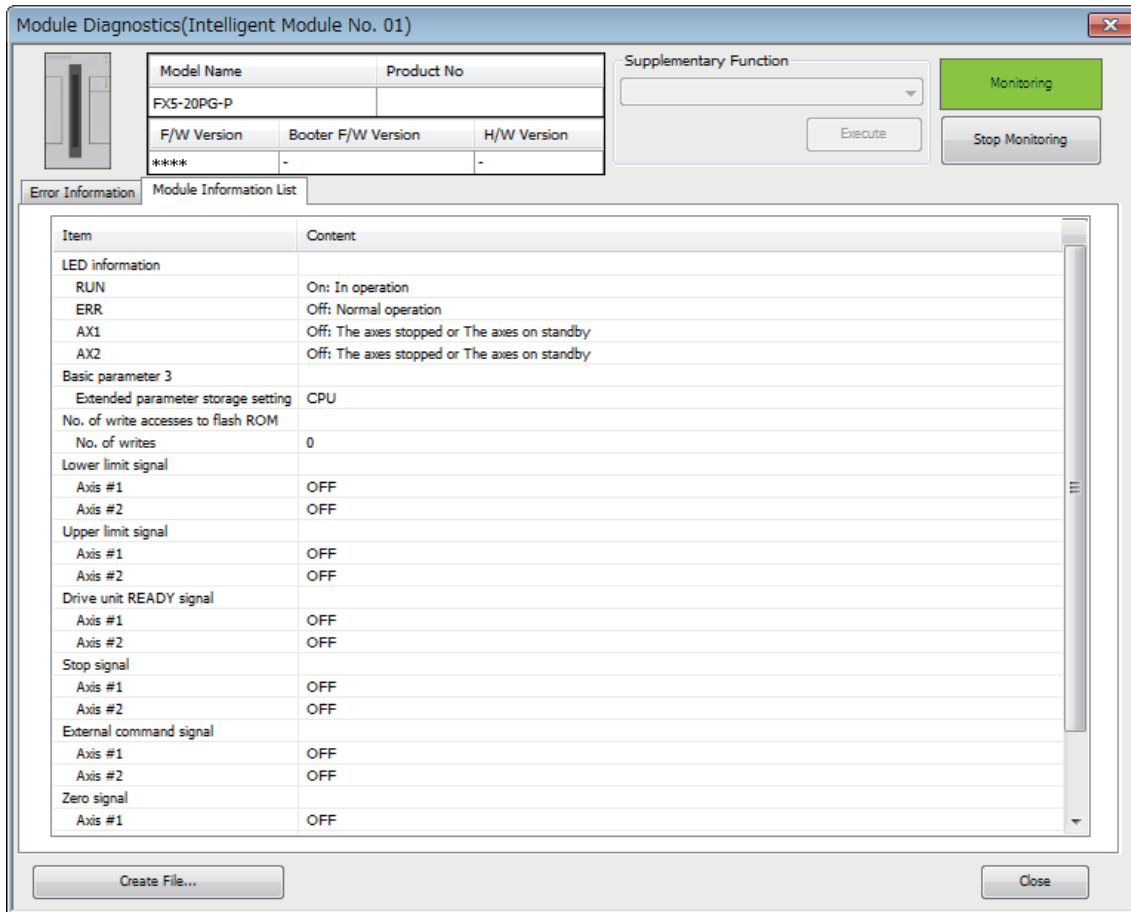

13.6 History Monitor Function

This function monitors the start history, error history, and warning history stored in the buffer memory of positioning module during the operation monitoring.

Start history

The start history of past 16 records of operations such as the positioning operation, JOG operation, and manual pulse generator operation can be monitored. Once 16 records are stored, the oldest record is overwritten with the latest record. Therefore, the latest 16 history records are stored at all times. This function allows users to check the operation sequence (whether the operations have been started in a predetermined sequence) when the system is started.

The start history can be checked using the positioning monitor window. The following describes the check method.

1. Display the Positioning Monitor window. (☞ Page 339 Positioning Monitor)
2. Select the Start History from the pull-down menu.

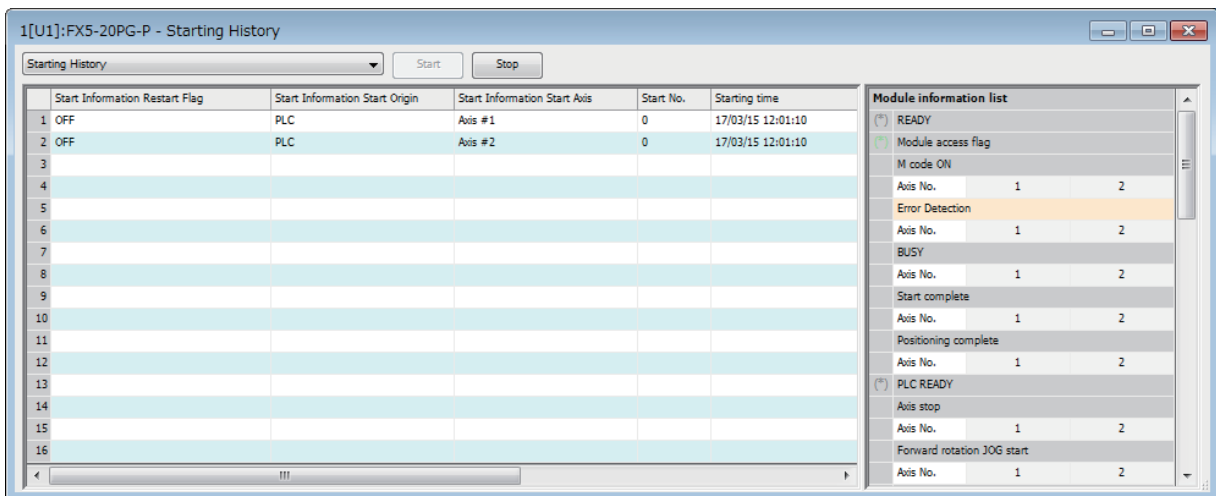

Error history and warning history

The error history and warning history of past 16 records can be monitored. Once 16 records are stored, the oldest record is overwritten with the latest record. Therefore, the latest 16 history records are stored at all times.

The error history and warning history can be checked using the positioning monitor window. The following describes the check method.

1. Display the Positioning Monitor window. (☞ Page 339 Positioning Monitor)
2. Select Error History or Warning History from the pull-down menu.

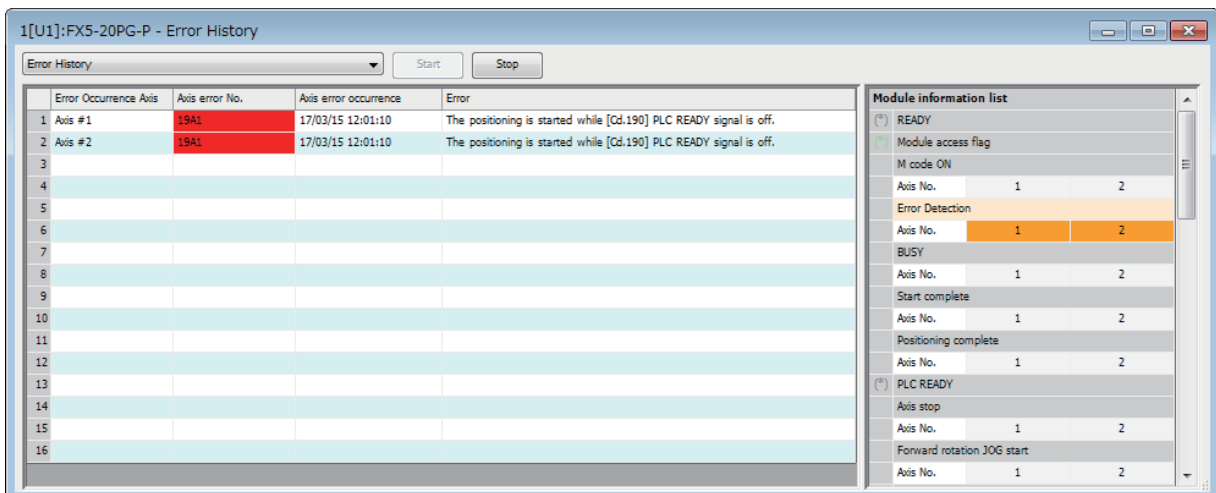

13.7 Event History Function

This function stores the error information in the data memory of the CPU module or the SD memory card as events. The stored event information can be displayed by the GX Works3, and the event history can be checked in time series. The detailed information of the error can be checked by referring to the "Additional information" of the detailed information.

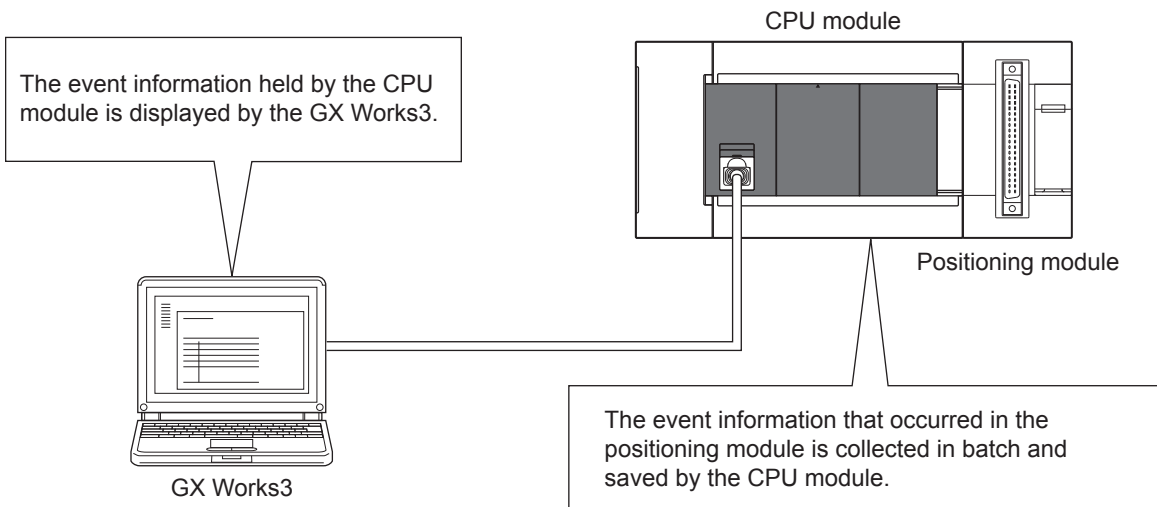

Point

For positioning module supported version of event history function, refer to Page 561 Added and Enhanced Functions.

For details on event history function, MELSEC iQ-F FX5 User's Manual (Application).
 For operation of event history function, GX Works3 Operating Manual.

History details

The following shows related items of the positioning module which can be checked by the event function.

- Events that occur in the positioning module
- The event history display contents
- Detailed information of error event
- Loss of event history

Event

The following table shows events that occur in the positioning module.

Event type	Description	Event item	Event code*1
Error	An error was detected in the positioning module.	Major error	03C00 to 03FFF
		Moderate error	02000 to 03BFF
		Minor error	01000 to 01FFF
Warning	A warning was detected in the positioning module.	Warning	00900 to 00CFF

*1 A leading 0 describes the "system". In the last four digits, an error code or a warning code is stored.

Detailed information

The following table shows the detailed information of the events that occur in the positioning module.

■Error event

The items displayed in the detailed information depend on error.

Add date 1	Add date 2	Add date 3
<ul style="list-style-type: none"> ■Positioning information <ul style="list-style-type: none"> • Occurrence axis number • Starting axis number • Occurrence data No. • Starting data No. • Occurrence timing • Occurrence point number • Starting point No. • Current feed value (Axis 1) • Current feed value (Axis 2) ■Dedicated instruction information <ul style="list-style-type: none"> • Axis in which the error occurred • Dedicated instruction number • Control data 	<ul style="list-style-type: none"> ■I/O signals <ul style="list-style-type: none"> • READY signal • Module access flag • BUSY signal • M code ON signal • Error detection signal • Start complete signal • Positioning complete signal • PLC READY signal • Axis stop signal • Forward JOG signal • Reverse JOG signal • Implementation prohibition flag • Positioning start signal • Lower limit signal • Upper limit signal • Drive unit READY signal • Stop signal • External command signal • Zero signal • Near-point dog signal 	—
<ul style="list-style-type: none"> ■Write information <ul style="list-style-type: none"> • Number of writing 	—	—
<ul style="list-style-type: none"> ■Parameter <ul style="list-style-type: none"> • Axis number • Setting value 	—	—
<ul style="list-style-type: none"> ■Parameter <ul style="list-style-type: none"> • Occurrence setting No. • Setting value 	—	—

■Warning event

The items displayed in the detailed information depend on warning.

Add date 1*1	Add date 2*1	Add date 3
<ul style="list-style-type: none"> ■Positioning information 	<ul style="list-style-type: none"> ■I/O signals 	—
<ul style="list-style-type: none"> ■Parameter 	—	—

*1 For details, refer to  Page 318 Error event.

Missing of event information

When the module errors of the positioning module frequently occur at intervals shorter than the event history correction intervals of the CPU module, the event history storage area in the positioning module may be filled with the uncollected error information of the CPU module. When a module error newly occurs in this state, the positioning module cancels the module error information, and outputs "**HST.LOSS**" (the event information is lost), a message showing the loss of the event information.

13.8 Amplifier-less Operation Function

With this function, user programs can be debugged at a start-up or positioning operations can be simulated by inputting a false external input signal from the buffer memory. External wiring with a drive unit or a limit switch is not required.

Control details

To use this function, switch the operation mode from the normal operation mode to the amplifier-less operation mode.

Operation mode	Description
Normal operation mode	<ul style="list-style-type: none"> The module is in this mode immediately after the power-on. In this mode, External I/O signal is connected and the positioning operation is performed.
Amplifier-less operation mode	<ul style="list-style-type: none"> In this mode, the setting in [Cd.44] External input signal operation device is used as a mock external input signal and the positioning operation is performed. The starting method of positioning control is the same as that in the normal operation mode.

If the operation mode is switched from the amplifier-less operation mode to the normal operation mode after the amplifier-less operation, the normal operation with External I/O signal connected can be performed.

■Current value

When the operation mode is switched between the normal operation mode and the amplifier-less operation mode, "0" is set in "[Md.20] Current feed value" and "[Md.21] Machine feed value".

■External I/O signal

The following table lists "Enabled external input signals" and "Output status of external output signals" in the normal operation mode and the amplifier-less operation mode.

External I/O signal		Normal operation mode	Amplifier-less operation mode
Enabled external input signals	Drive unit READY signal	Input from external devices	Setting in [Cd.44] External input signal operation device
	Stop signal		
	Upper limit signal		
	Lower limit signal		
	Zero signal		
	Near-point dog signal		
	External command signal		
	Manual pulse generator		
Output status of external output signals	Deviation counter clear	Output to external devices	No output to external devices
	Pulse output		



Operation mode switching between the normal operation mode and the amplifier-less operation mode is reflected on all axes in a batch. The operation mode cannot be switched for each axis.

Restrictions

- In the amplifier-less operation mode, the following monitor data operations differ from those in the normal operation mode.

Monitor item		Monitor details		Buffer memory address		
				Axis 1	Axis 2	
[Md.30]	External I/O signal	The ON or OFF state of External I/O signal is stored.		816	916	
		b0	Lower limit signal			The ON or OFF state set in [Cd.44] External input signal operation device is reflected on these signals.
		b1	Upper limit signal			
		b2	Drive unit READY signal			
		b3	Stop signal			
		b4	External command signal			
		b5	Zero signal			
		b6	Near-point dog signal			
		b7	Use prohibited			—
		b8	Deviation counter clear signal			These signals turn on or off in the same way in the normal operation mode.
b9 to b15	Use prohibited	—				

- If the module is powered on or the CPU module is reset in the amplifier-less operation mode, the operation mode is switched to the normal operation mode.
- Acquisition timing of external input signals and start timing differ between the amplifier-less operation mode and the normal operation mode. Check the actual operation with the actual equipment.
- The amplifier-less operation function cannot be used in the test mode. If the amplifier-less operation mode is requested in the test mode, Error at switching from normal operation mode to amplifier-less operation mode (Error code: 18B0H) occurs and the operation mode is not switched.
- The drive unit must not be connected to perform normal operation mode→amplifier-less operation mode and amplifier-less operation mode→normal operation mode transitions. Pulses may be output to the drive unit during mode transitions with the drive unit connected.

Setting method

The following table lists the data used with the amplifier-less operation function.

■System control data

Setting item		Setting value	Setting detail	Initial value at the factory	Buffer memory address			
					Axis 1	Axis 2		
[Cd.137]	Amplifier-less operation mode switching request	→	Switches the operation mode. <ul style="list-style-type: none"> • ABCDH: Switching from the normal operation mode to the amplifier-less operation mode • 0000H: Switching from the amplifier-less operation mode to the normal operation mode 	0000H	1926			
[Cd.44]	External input signal operation device	→	Set the external input signal status for the amplifier-less operation mode. (Acquisition cycle: 0.88 ms)	0000H	1928	1929		
			b0				Lower limit signal	<ul style="list-style-type: none"> • 0: OFF • 1: ON
			b1				Upper limit signal	
			b2				Drive unit READY signal	
			b3				Stop signal	
			b4				External command signal	
			b5				Zero signal	
			b6				Near-point dog signal	
b7 to b15	Use prohibited	Set 0.						

■System monitor data

Monitor item		Monitor value	Monitor details	Buffer memory address	
				Axis 1	Axis 2
[Md.70]	Amplifier-less operation mode status	→	Indicates the current operation mode. <ul style="list-style-type: none"> • 0: In normal operation mode • 1: In amplifier-less operation mode 	1201	

Operation mode switching procedure

■ Switching from the normal operation mode to the amplifier-less operation mode

1. Stop all operating axes, and check that BUSY signals of all axes are off.
2. Turn off "[Cd.190] PLC READY signal".
3. Check that READY signal ([Md.140] Module status: b0) is off.
4. Set "ABCDH" in "[Cd.137] Amplifier-less operation mode switching request".
5. Check that "[Md.70] Amplifier-less operation mode status" is set to "1: In amplifier-less operation mode".

■ Switching from the amplifier-less operation mode to the normal operation mode

1. Stop all operating axes, and check that BUSY signals of all axes are off.
2. Turn off "[Cd.190] PLC READY signal".
3. Check that READY signal ([Md.140] Module status: b0) is off.
4. Set "0000H" in "[Cd.137] Amplifier-less operation mode switching request".
5. Check that "[Md.70] Amplifier-less operation mode status" is set to "0: In normal operation mode".

■ Operation chart

The following chart shows switching operation between the normal operation mode and the amplifier-less operation mode.

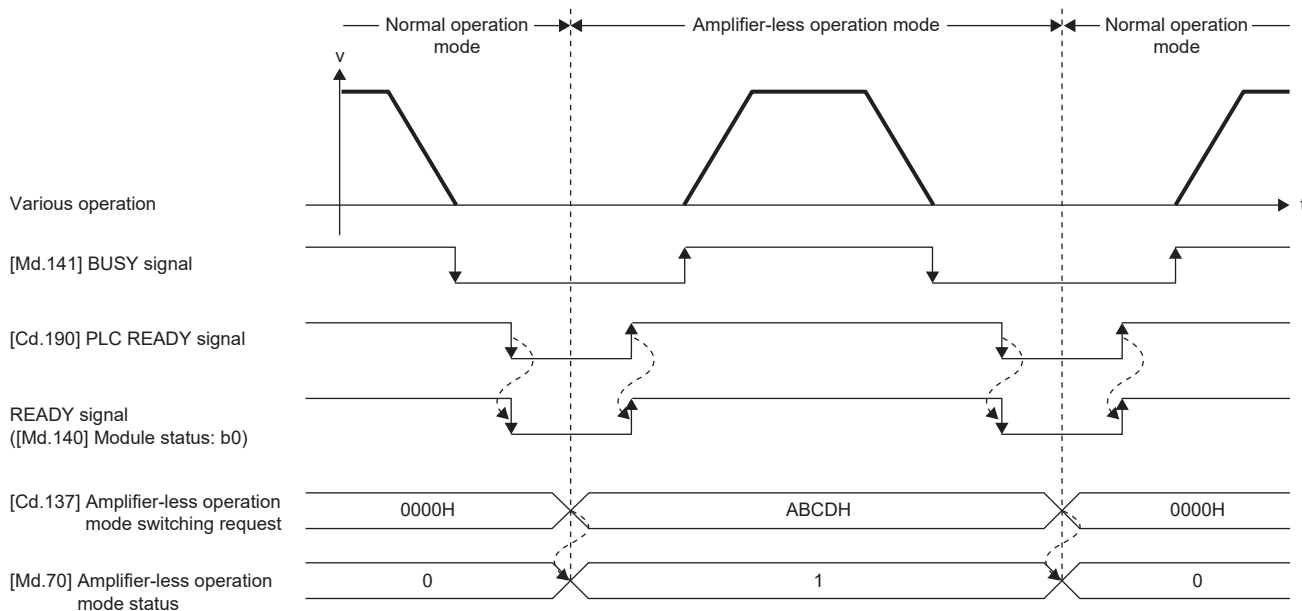

Point

- Excluding Module access flag ([Md.140] Module status: b1), check that the all input signals ([Md.140] Module status: b0, [Md.141] BUSY signal, [Md.31] Status: b12 to b15) are off and then switch the operation mode between the normal operation mode and the amplifier-less operation mode. If the operation mode is switched while any of input signals other than Module access flag ([Md.140] Module status: b1) are on, the switching from normal operation mode to amplifier-less operation mode error (Error code: 18B0H) or the switching from amplifier-less operation mode to normal operation mode error (Error code: 18B1H) occurs, and the operation mode transition is not performed.
- The switching operation is enabled when "0000H" or "ABCDH" is set in "[Cd.137] Amplifier-less operation mode switching request". If a value other than "0000H" or "ABCDH" is set, the operation mode is not switched and error detection is not performed.
- The operation mode is switched to the amplifier-less operation mode only when "[Cd.137] Amplifier-less operation mode switching request" is set to "ABCDH" from "0000H". The operation mode is switched to the normal operation mode only when "[Cd.137] Amplifier-less operation mode switching request" is set to "0000H" from "ABCDH".

14 PARAMETER SETTING

This chapter describes the parameter setting of the positioning module. By setting parameters, the parameter setting by program is not needed.

The parameter setting has two types including the module parameter and module extension parameter.

14.1 Parameter Setting Procedure

1. Add the positioning module in GX Works3.

 [Navigation] ⇒ [Parameter] ⇒ [Module Information] ⇒ Right-click ⇒ [Add New Module]

2. The parameter setting has two types including the module parameter and module extension parameter. Select either of them from the tree on the following window.

 [Navigation] ⇒ [Parameter] ⇒ [Module Information] ⇒ [Target module]

3. Write the settings to the CPU module using GX Works3.

 [Online] ⇒ [Write to PLC]

4. The settings are reflected by resetting the CPU module or powering off and on the system.

14.2 Module Parameters

Set the module parameter. The module parameter has the basic setting, application setting, interrupt setting, and refresh setting.

Select the module parameter from the tree on the following window.

 [Navigation] ⇒ [Parameter] ⇒ [Module Information] ⇒ [Target module] ⇒ [Module Parameter]

Basic setting

Set the parameter required to use the positioning module.

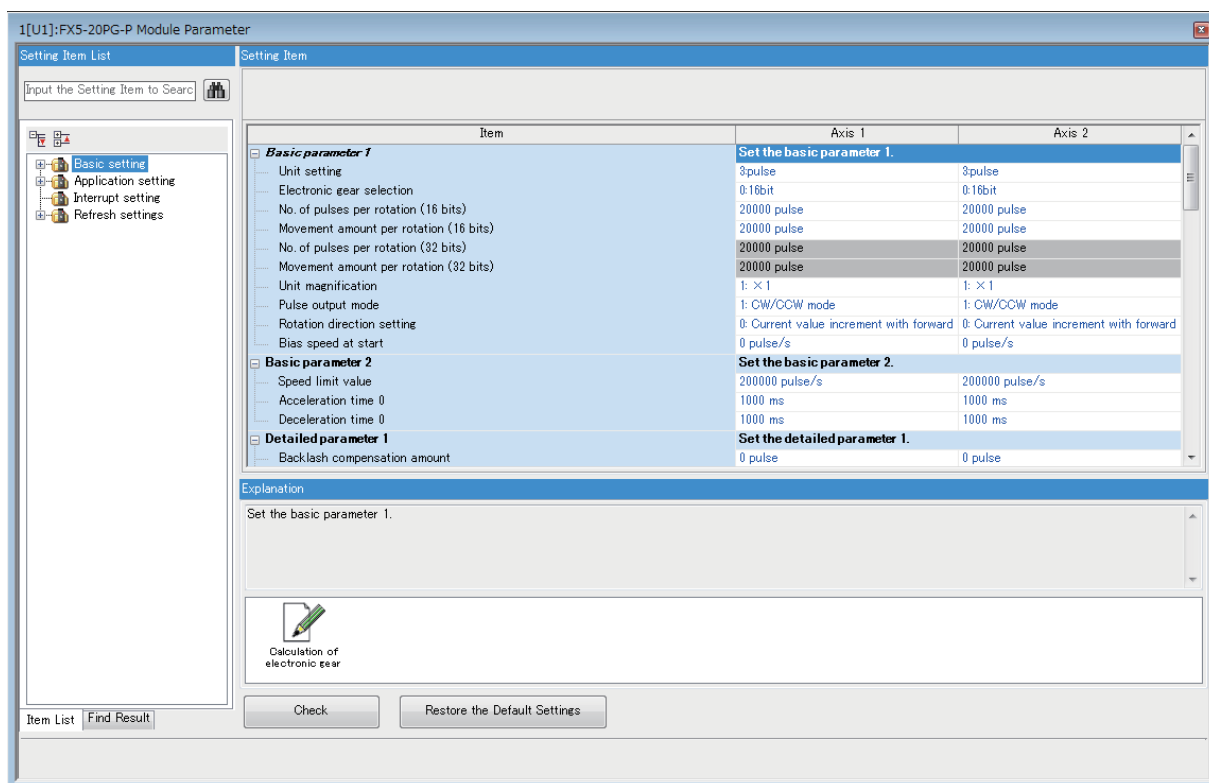

Item	Setting range	Reference
■Basic parameter 1		
Unit setting	<ul style="list-style-type: none"> • 0: mm • 1: inch • 2: degree • 3: pulse (default value) 	Page 385 [Pr.1] Unit setting
Electronic gear selection	<ul style="list-style-type: none"> • 0: 16bit (default value) • 1: 32bit 	Page 392 [Pr.62] Electronic gear selection
No. of pulses per rotation (16 bits)	1 to 65535 pulses (default value: 20000)	Page 386 [Pr.2] No. of pulses per rotation (16 bits) (Ap)
Movement amount per rotation (16 bits)	Refer to the right item. (default value: 20000)	Page 387 [Pr.3] Movement amount per rotation (16 bits) (Al)
No. of pulses per rotation (32 bits)	1 to 200000000 pulses (default value: 20000)	Page 392 [Pr.2] No. of pulses per rotation (32 bits) (Ap)
Movement amount per rotation (32 bits)	Refer to the right item. (default value: 20000)	Page 393 [Pr.3] Movement amount per rotation (32 bits) (Al)
Unit magnification	<ul style="list-style-type: none"> • 1: ×1 (default value) • 10: ×10 • 100: ×100 • 1000: ×1000 	Page 387 [Pr.4] Unit magnification
Pulse output mode	<ul style="list-style-type: none"> • 0: PULSE/SIGN mode • 1: CW/CCW mode (default value) • 2: A-phase/B-phase multiple of 4 • 3: A-phase/B-phase multiple of 1 	Page 388 [Pr.5] Pulse output mode

Item	Setting range	Reference
Rotation direction setting	<ul style="list-style-type: none"> 0: Current value increment with forward run pulse output (default value) 1: Current value increment with reverse run pulse output 	Page 390 [Pr.6] Rotation direction setting
Bias speed at start	Refer to the right item. (default value: 0)	Page 391 [Pr.7] Bias speed at start
■Basic parameter 2		
Speed limit value	Refer to the right item. (default value: 200000)	Page 394 [Pr.8] Speed limit value
Acceleration time 0	1 to 8388608 ms (default value: 1000)	Page 395 [Pr.9] Acceleration time 0, [Pr.10] Deceleration time 0
Deceleration time 0		
■Detailed parameter 1		
Backlash compensation amount	Refer to the right item. (default value: 0)	Page 396 [Pr.11] Backlash compensation amount
Software stroke limit upper limit value	Refer to the right item. (default value: 2147483647)	Page 397 [Pr.12] Software stroke limit upper limit value
Software stroke limit lower limit value	Refer to the right item. (default value: -2147483648)	Page 397 [Pr.13] Software stroke limit lower limit value
Software stroke limit selection	<ul style="list-style-type: none"> 0: Apply software limit for current feed value (default value) 1: Apply software limit for machine feed value 	Page 398 [Pr.14] Software stroke limit selection
Software stroke limit valid/invalid setting	<ul style="list-style-type: none"> 0: Enable (default value) 1: Disable 	Page 398 [Pr.15] Software stroke limit valid/invalid setting
Command in-position width	Refer to the right item. (default value: 100)	Page 398 [Pr.16] Command in-position width
Torque limit setting value	1 to 5000 (default value: 300)	Page 399 [Pr.17] Torque limit setting value
M code ON signal output timing	<ul style="list-style-type: none"> 0: WITH mode (default value) 1: AFTER mode 	Page 400 [Pr.18] M code ON signal output timing
Speed switching mode	<ul style="list-style-type: none"> 0: Standard speed switching mode (default value) 1: Front-loading speed switching mode 	Page 400 [Pr.19] Speed switching mode
Interpolation speed specification method	<ul style="list-style-type: none"> 0: Composite speed (default value) 1: Reference axis speed 	Page 401 [Pr.20] Interpolation speed specification method
Current feed value during speed control	<ul style="list-style-type: none"> 0: Do not update current feed value (default value) 1: Updated current feed value 2: Clear current feed value to 0 	Page 401 [Pr.21] Current feed value during speed control
Input signal logic selection: Lower limit signal	<ul style="list-style-type: none"> 0: Negative logic (default value) 1: Positive logic 	Page 402 [Pr.22] Input signal logic selection
Input signal logic selection: Upper limit signal		
Input signal logic selection: Drive unit READY signal		
Input signal logic selection: Stop signal		
Input signal logic selection: External command signal		
Input signal logic selection: Zero signal		
Input signal logic selection: Near-point DOG signal Drive		
Input signal logic selection: Manual pulse generator input		
Output signal logic selection: Command pulse signal	<ul style="list-style-type: none"> 0: Negative logic (default value) 1: Positive logic 	Page 402 [Pr.23] Output signal logic selection
Output signal logic selection: Deviation counter clear		
Manual pulse generator input selection	<ul style="list-style-type: none"> 0: A-phase/B-phase multiple of 4 (default value) 1: A-phase/B-phase multiple of 2 2: A-phase/B-phase multiple of 1 3: PULSE/SIGN 	Page 403 [Pr.24] Manual pulse generator input selection
Speed-position function selection	<ul style="list-style-type: none"> 0: Speed-position switching control (INC mode) (default value) 2: Speed-position switching control (ABS mode) 	Page 403 [Pr.150] Speed-position function selection

Item	Setting range	Reference
■Detailed parameter 2		
Acceleration time 1	1 to 8388608 ms (default value: 1000)	Page 404 [Pr.25] Acceleration time 1 to [Pr.27] Acceleration time 3
Acceleration time 2		
Acceleration time 3		
Deceleration time 1		Page 404 [Pr.28] Deceleration time 1 to [Pr.30] Deceleration time 3
Deceleration time 2		
Deceleration time 3		
JOG speed limit value	Refer to the right item. (default value: 20000)	Page 405 [Pr.31] JOG speed limit value
JOG operation acceleration time selection	<ul style="list-style-type: none"> • 0: Acceleration time 0 (default value) • 1: Acceleration time 1 • 2: Acceleration time 2 • 3: Acceleration time 3 	Page 405 [Pr.32] JOG operation acceleration time selection
JOG operation deceleration time selection	<ul style="list-style-type: none"> • 0: Acceleration time 0 (default value) • 1: Deceleration time 1 • 2: Deceleration time 2 • 3: Deceleration time 3 	Page 406 [Pr.33] JOG operation deceleration time selection
Acceleration/deceleration processing selection	<ul style="list-style-type: none"> • 0: Trapezoidal acceleration/deceleration processing (default value) • 1: S-curve acceleration/deceleration processing 	Page 406 [Pr.34] Acceleration/deceleration processing selection
S-curve ratio	1 to 100 % (default value: 100)	Page 407 [Pr.35] S-curve ratio
Sudden stop deceleration time	1 to 8388608 ms (default value: 1000)	Page 408 [Pr.36] Sudden stop deceleration time
Stop group 1 sudden stop selection	<ul style="list-style-type: none"> • 0: Normal deceleration stop (default value) • 1: Sudden stop 	Page 409 [Pr.37] to [Pr.39] Stop group 1 to 3 sudden stop selection
Stop group 2 sudden stop selection		
Stop group 3 sudden stop selection		
Positioning complete signal output time	0 to 65535 ms (default value: 300)	Page 410 [Pr.40] Positioning complete signal output time
Allowable circular interpolation error width	Refer to the right item. (default value: 100)	Page 411 [Pr.41] Allowable circular interpolation error width
External command function selection	<ul style="list-style-type: none"> • 0: External positioning start (default value) • 1: External speed change request • 2: Speed-position control switching request • 3: Skip request 	Page 412 [Pr.42] External command function selection
Start adjustment time	0.00 to 10000.00 ms (default value: 0.00)	Page 412 [Pr.82] Start adjustment time
■OPR basic parameter		
OPR method	<ul style="list-style-type: none"> • 0: Near-point dog method (default value) • 1: Stopper method 1 • 2: Stopper method 2 • 3: Stopper method 3 • 4: Count method 1 • 5: Count method 2 • 6: Data setting method 	Page 413 [Pr.43] OPR method
OPR direction	<ul style="list-style-type: none"> • 0: Positive direction (Address increase direction) (default value) • 1: Reverse direction (address decrement) 	Page 414 [Pr.44] OPR direction
OP address	Refer to the right item. (default value: 0)	Page 415 [Pr.45] OP address
OPR speed	Refer to the right item. (default value: 1)	Page 415 [Pr.46] OPR speed
Creep speed	Refer to the right item. (default value: 1)	Page 416 [Pr.47] Creep speed
OPR retry	<ul style="list-style-type: none"> • 0: Do not perform OPR retry with limit switches (Default value) • 1: Perform the OPR retry with limit switches 	Page 417 [Pr.48] OPR retry

Item	Setting range	Reference
■OPR detailed parameter		
OPR dwell time	0 to 65535 ms (default value: 0)	Page 417 [Pr.49] OPR dwell time
Setting for the movement amount after near-point dog ON	Refer to the right item. (default value: 0)	Page 418 [Pr.50] Setting for the movement amount after near-point dog ON
OPR acceleration time selection	<ul style="list-style-type: none"> • 0: Acceleration time 0 (default value) • 1: Acceleration time 1 • 2: Acceleration time 2 • 3: Acceleration time 3 	Page 419 [Pr.51] OPR acceleration time selection
OPR deceleration time selection	<ul style="list-style-type: none"> • 0: Acceleration time 0 (default value) • 1: Deceleration time 1 • 2: Deceleration time 2 • 3: Deceleration time 3 	Page 419 [Pr.52] OPR deceleration time selection
OP shift amount	Refer to the right item. (default value: 0)	Page 420 [Pr.53] OP shift amount
OPR torque limit value	1 to 3000 (default value: 300)	Page 421 [Pr.54] OPR torque limit value
Deviation counter clear signal output time	1 to 65535 ms (default value: 11)	Page 421 [Pr.55] Deviation counter clear signal output time
Speed specification during OP shift	<ul style="list-style-type: none"> • 0: OPR speed (default value) • 1: Creep speed 	Page 421 [Pr.56] Speed specification during OP shift
Dwell time during OPR retry	0 to 65535 ms (default value: 0)	Page 422 [Pr.57] Dwell time during OPR retry
Setting of operation during uncompleted OPR	<ul style="list-style-type: none"> • 0: Do not execute positioning control (default value) • 1: Execute positioning control 	Page 422 [Pr.58] Setting of operation during uncompleted OPR
■Basic parameter 3^{*1}		
Extended parameter storage setting	<ul style="list-style-type: none"> • CPU (default value) • Positioning module 	—

*1 The basic parameter 3 setting is available only in GX Works3.

Application setting

Set CPU error output mode setting of the positioning module.

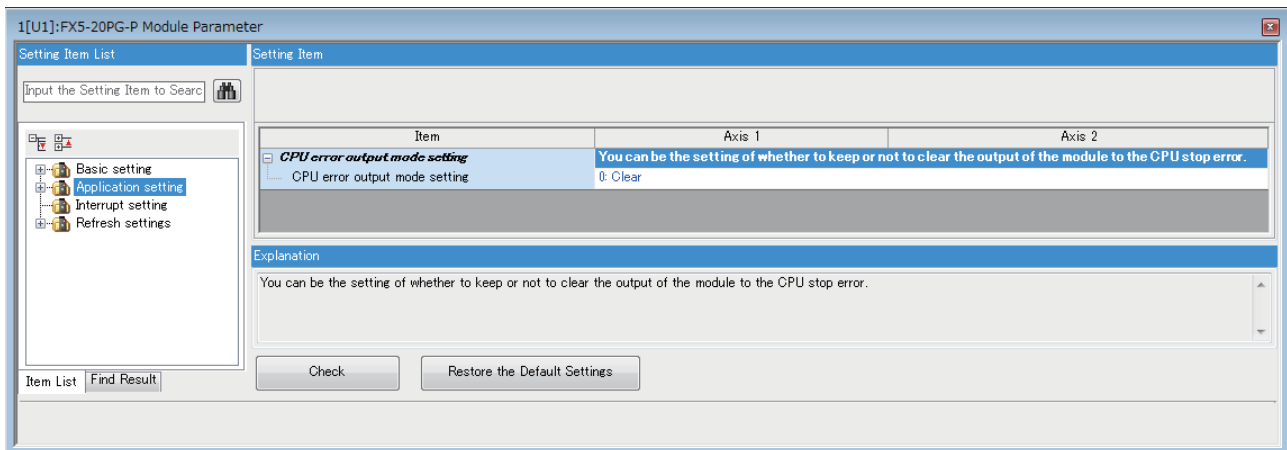

Interrupt setting

Set the interrupt function of the positioning module.

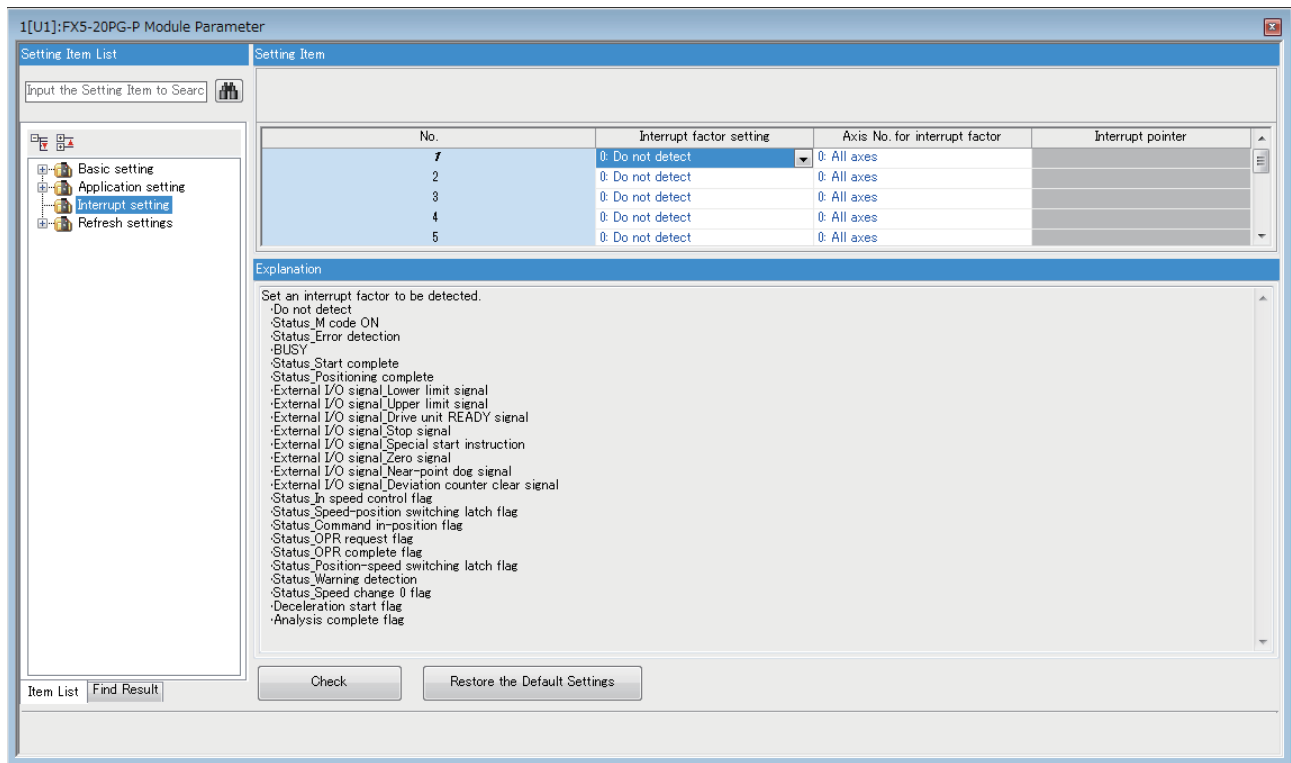

Item	Setting range	Reference
Interrupt factor setting	<ul style="list-style-type: none"> • 0: Do not detect (Default value) • 1: Status_M code ON • 2: Status_Error detection • 3: BUSY • 4: Status_Start complete • 5: Status_Positioning complete • 100: External I/O signal_Lower limit signal • 101: External I/O signal_Upper limit signal • 102: External I/O signal_Drive unit READY signal • 103: External I/O signal_Stop signal • 104: External I/O signal_Special start instruction • 105: External I/O signal_Zero signal • 106: External I/O signal_Near-point dog signal • 107: External I/O signal_Deviation counter clear signal • 200: Status_In speed control flag • 201: Status_Speed-position switching latch flag • 202: Status_Command in-position flag • 203: Status_OPR request flag • 204: Status_OPR complete flag • 205: Status_Position-speed switching latch flag • 206: Status_Warning detection • 207: Status_Speed change 0 flag • 300: Deceleration start flag • 301: Analysis complete flag 	Page 485 [Pr.900] Interrupt factor setting
Axis No. for interrupt factor	<ul style="list-style-type: none"> • 0: All axes (default value) • 1: Axis 1 • 2: Axis 2 	Page 485 [Pr.901] Axis No. for interrupt factor
Interrupt pointer	150 to I177*1	—

*1 For details on the available interrupt pointers, refer to the following.
 📖 MELSEC iQ-F FX5 User's Manual (Application)

Refresh settings

Configure the setting to transfer the values in the buffer memory of the positioning module to devices in the CPU module. By configuring these refresh settings, reading the data by program is not needed.

Select the transfer destination from the following at "Target".

- Specified device ( Page 330 Specified device)

Specified device

Transfer the setting of the buffer memory to the specified device of the CPU module. The device X, Y, M, L, B, D, W, and R can be specified. To use the bit device X, Y, M, L, or B, set a number which is divisible by 16 points (example: X20, Y120, M16). The data in the buffer memory is stored in devices for 16 points from the set number.

Ex.

When X20 is set, data is stored in X20 to X37.

Setting item

The refresh setting has the following items.

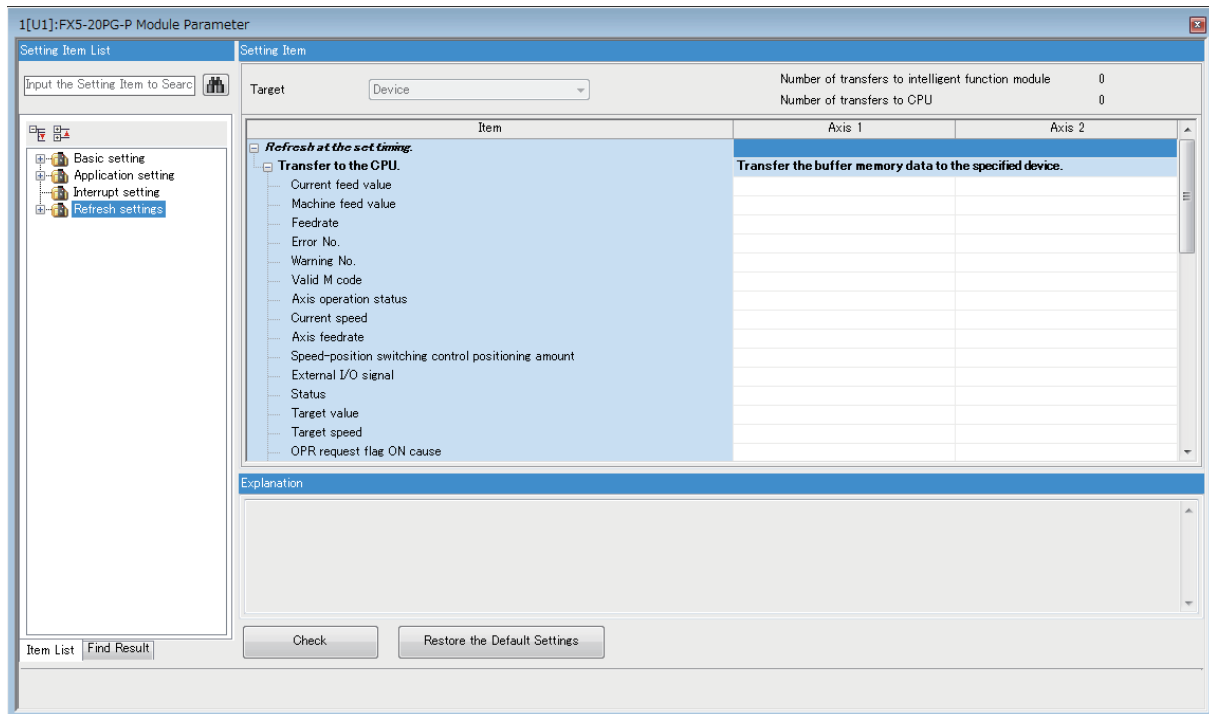

Item	Reference
■Refresh at the set timing (transfer to CPU)	
Current feed value	Page 454 [Md.20] Current feed value
Machine feed value	Page 454 [Md.21] Machine feed value
Feedrate	Page 455 [Md.22] Feedrate
Error No.	Page 455 [Md.23] Axis error No.
Warning No.	Page 455 [Md.24] Axis warning No.
Valid M code	Page 455 [Md.25] Valid M code
Axis operation status	Page 456 [Md.26] Axis operation status
Current speed	Page 456 [Md.27] Current speed
Axis feedrate	Page 457 [Md.28] Axis feedrate
Speed-position switching control positioning amount	Page 457 [Md.29] Speed-position switching control positioning amount
External I/O signal	Page 458 [Md.30] External I/O signal
Status	Page 458 [Md.31] Status
Target value	Page 460 [Md.32] Target value

Item	Reference
Target speed	Page 460 [Md.33] Target speed
OPR request flag ON cause	Page 461 [Md.63] OPR request flag ON factor
Positioning control end cause	Page 461 [Md.64] Positioning control complete factor
Movement amount after near-point dog ON	Page 461 [Md.34] Movement amount after near-point dog ON
Torque limit stored value	Page 462 [Md.35] Torque limit stored value
Special start data instruction code setting value	Page 462 [Md.36] Special start data instruction code setting value
Special start data instruction parameter setting value	Page 462 [Md.37] Special start data instruction parameter setting value
Start positioning data No. setting value	Page 462 [Md.38] Start positioning data No. setting value
In speed limit flag	Page 463 [Md.39] In speed limit flag
In speed change processing flag	Page 463 [Md.40] In speed change processing flag
Special start repetition counter	Page 463 [Md.41] Special start repetition counter
Control system repetition counter	Page 463 [Md.42] Control method repetition counter
Start data pointer being executed	Page 464 [Md.43] Start data pointer being executed
Positioning data No. being executed	Page 464 [Md.44] Positioning data No. being executed
Block No. being executed	Page 464 [Md.45] Block No. being executed
Last executed positioning data No.	Page 464 [Md.46] Last executed positioning data No.
Positioning data being executed_Positioning identifier	Page 465 [Md.47] Positioning data being executed
Positioning data being executed_M code	
Positioning data being executed_Dwell time	
Positioning data being executed_Positioning option	
Positioning data being executed_Command speed	
Positioning data being executed_Positioning address	
Positioning data being executed_Arc address	
Analysis mode	Page 465 [Md.60] Analysis mode
Analysis complete flag	Page 465 [Md.61] Analysis complete flag
Deceleration start flag	Page 466 [Md.48] Deceleration start flag
■Refresh Timing^{*1}	
Refresh Timing	Page 331 Refresh Timing
Refresh Group [n] (n: 1-64)	—
■Refresh Timing (I/O)^{*1}	
Refresh Timing	—

*1 The setting cannot be changed from the default in the positioning module.

■Refresh Timing

Set the refresh timing of the specified refresh destination.

Setting value	Description
At the Execution Time of END Instruction	Performs refresh at END processing of the CPU module.

Refresh processing time

A refresh processing time [μs] is a constituent of the scan time of the CPU module. For details on the scan time, refer to the following.

 MELSEC iQ-F FX5 User's Manual (Application)

The refresh processing time [μs], which is taken for refresh processing, is given by:

- Refresh processing time [μs] = Refresh read time (refresh data transfer to the CPU module)

■When "Target" is a specified device

Calculate the refresh read time according to the number of items and the number of their transfer data (word) that are set to be refreshed.

Item	Description	
Refresh read time	Number of refresh read settings	Number of used devices
	Refresh time for a 1 to n number of parameters	0.05 μs per word

14.3 Module Extension Parameter

Set the module extension parameter. The module extension parameter has positioning data and block start data number 0 to 4 for each axis.

Select the module extension parameter from the tree on the following window.

 [Navigation] ⇒ [Parameter] ⇒ [Module Information] ⇒ [Target module] ⇒ [Module Extended Parameter]

Positioning data

Set the positioning data for each axis.

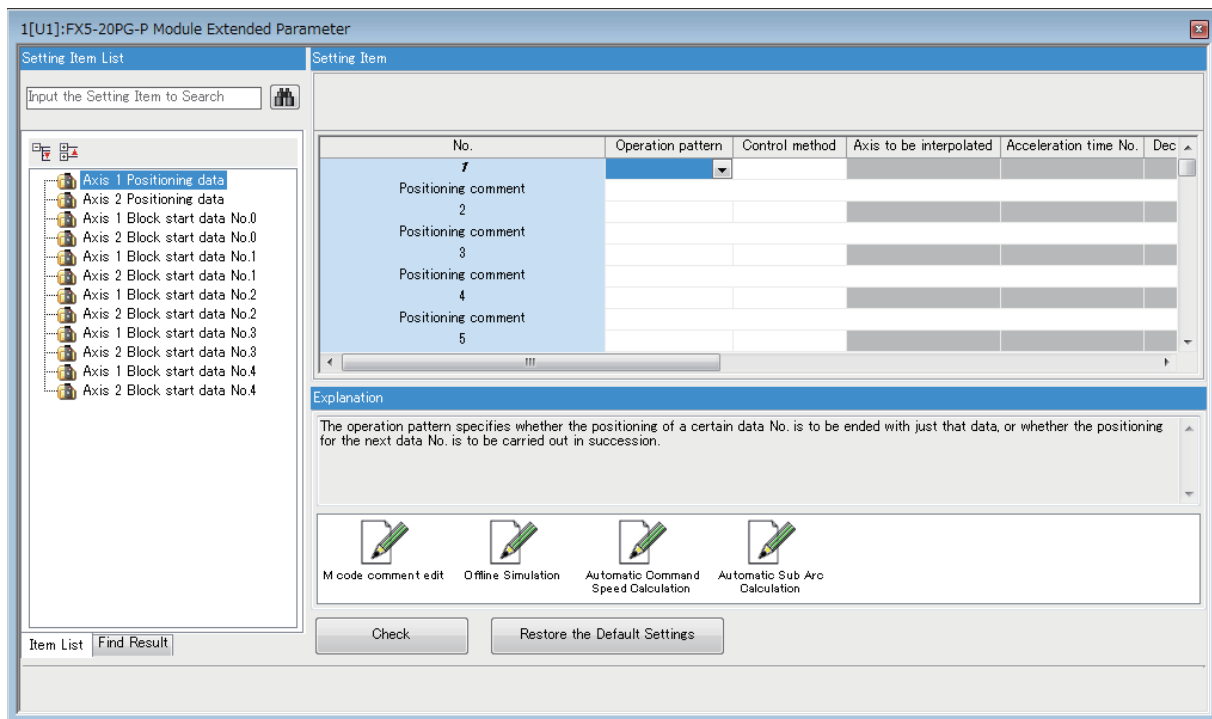

Item	Setting range	Reference
Operation pattern	<ul style="list-style-type: none"> • 0: Positioning complete • 1: Continuous positioning control • 3: Continuous path control 	Page 424 [Da.1] Operation pattern

Item	Setting range	Reference
Control method	<ul style="list-style-type: none"> • 01H: ABS1 1-axis linear control (ABS) • 02H: INC1 1-axis linear control (INC) • 03H: FEED1 1-axis fixed-feed control • 04H: VF1 1-axis speed control (forward run) • 05H: VR1 1-axis speed control (reverse run) • 06H: VPF Speed-position switching control (forward run) • 07H: VPR Speed-position switching control (reverse run) • 08H: PVF Position-speed switching control (forward run) • 09H: PVR Position-speed switching control (reverse run) • 0AH: ABS2 2-axis linear interpolation control (ABS) • 0BH: INC2 2-axis linear interpolation control (INC) • 0CH: FEED2 Fixed-feed control by 2-axis linear interpolation • 0DH: ABS \frown Circular interpolation control with sub point specified (ABS) • 0EH: INC \frown Circular interpolation control with sub point specified (INC) • 0FH: ABS. Circular interpolation control with center point specified (ABS, CW) • 10H: ABS. Circular interpolation control with center point specified (ABS, CCW) • 11H: INC. Circular interpolation control with center point specified (INC, CW) • 12H: INC. Circular interpolation control with center point specified (INC, CCW) • 13H: VF2 2-axis speed control (forward run) • 14H: VR2 2-axis speed control (reverse run) • 80H: NOP NOP instruction • 81H: POS Current value change • 82H: JUMP JUMP instruction • 83H: LOOP Beginning of LOOP-to-LEND processing • 84H: LEND End of LOOP-to-LEND processing 	Page 425 [Da.2] Control method
Axis to be interpolated	<ul style="list-style-type: none"> • 0: Axis 1 specification • 1: Axis 2 specification 	Page 426 [Da.5] Axis to be interpolated
Acceleration time No.	<ul style="list-style-type: none"> • 0: Acceleration time 0 • 1: Acceleration time 1 • 2: Acceleration time 2 • 3: Acceleration time 3 	Page 426 [Da.3] Acceleration time No.
Deceleration time No.	<ul style="list-style-type: none"> • 0: Deceleration time 0 • 1: Deceleration time 1 • 2: Deceleration time 2 • 3: Deceleration time 3 	Page 426 [Da.4] Deceleration time No.
Positioning address	Refer to the right item.	Page 427 [Da.6] Positioning address/movement amount
Arc address	Refer to the right item.	Page 429 [Da.7] Arc address
Command speed	Refer to the right item.	Page 430 [Da.8] Command speed
Dwell time	<ul style="list-style-type: none"> • 0 to 65535 ms • 1 to 600 	Page 431 [Da.9] Dwell time
M code	<ul style="list-style-type: none"> • 0 to 10 • 1 to 65535 • 0 to 65535 	Page 432 [Da.10] M code
M code ON signal output timing	<ul style="list-style-type: none"> • 0: Use the set value of M code ON signal output timing • 1: WITH mode • 2: AFTER mode 	Page 432 [Da.27] M code ON signal output timing
ABS direction in degrees	<ul style="list-style-type: none"> • 0: Use the set value of ABS direction in degrees • 1: ABS clockwise • 2: ABS counterclockwise • 3: Shortcut (direction setting invalid) 	Page 433 [Da.28] ABS direction in degrees
Interpolation speed specification method	<ul style="list-style-type: none"> • 0: Use the set value of Interpolation speed specification method • 1: Composite speed • 2: Reference axis speed 	Page 433 [Da.29] Interpolation speed specification method

M code comment edit

Set comments for M codes. The set comments are saved in a project.

Setting method



M code comment edit

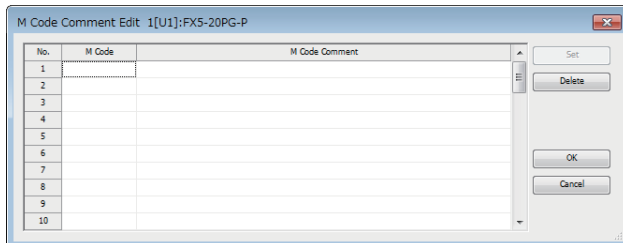

1. Double-click "M code comment edit" in "Axis □ Positioning data".
2. Input an M code number for which a comment is set in "M Code" in the range of 1 to 65535. The maximum number of M codes for which comments can be set is 50.
3. Input a comment in "M Code Comment".
4. Click the [OK] button.

Offline Simulation

Offline simulations enable simulation of operation (waveforms) of configured positioning data.

Setting method



Offline Simulation

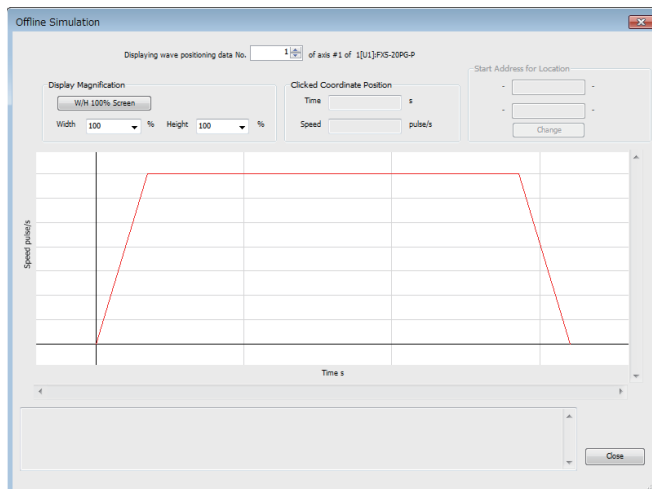

1. Double-click on "Offline Simulation" for the "Axis □ Positioning Data".
2. Set "Positioning Data No." to the positioning data number corresponding to the waveform you want to display.
3. The waveform corresponding to the positioning data setting appears.

Restriction

The following control methods are available for use with Offline Simulation.

- 01H: ABS1 1-axis linear control (ABS)
- 02H: INC1 1-axis linear control (INC)
- 03H: FEED1 1-axis fixed-feed control
- 0AH: ABS2 2-axis linear interpolation control (ABS)
- 0BH: INC2 2-axis linear interpolation control (INC)
- 0CH: FEED2 Fixed-feed control by 2-axis linear interpolation
- 0DH: ABS \frown Circular interpolation control with sub point specified (ABS)
- 0EH: INC \frown Circular interpolation control with sub point specified (INC)
- 0FH: ABS. Circular interpolation control with center point specified (ABS, CW)
- 10H: ABS. Circular interpolation control with center point specified (ABS, CCW)

Automatic Command Speed Calculation

The automatic command speed calculation calculates the command speed from various conditions.

Setting method



Automatic Command Speed Calculation

Automatic Command Speed Calculation

Entry

[Operation Procedure]
 1. Select a positioning data No. to calculate the command speed.
 2. Set the travel distance, operation time, acceleration time and deceleration time.
 3. Click the "Calculate Command Speed" button.

Edit the positioning data No. of axis #1.
 Because the control method of this data is 01H:ABS line 1 edit and calculation are not enabled.

* Control method is ABS. Please calculate and enter travel distance based on the previous positioning position.

Travel Distance pulse Operation Time ms
 Acceleration Time ms Deceleration Time ms

Explanation
 Enter the amount of time measured in ms to reach the target position.
 Range: 1 to 2147483647

Calculation Result

No.	Operation pattern	Control method	Positioning address	Command speed
1	0:END	01H:ABS line 1	10000 pulse	22940 pulse/s

Click OK to reflect this data to the positioning data.

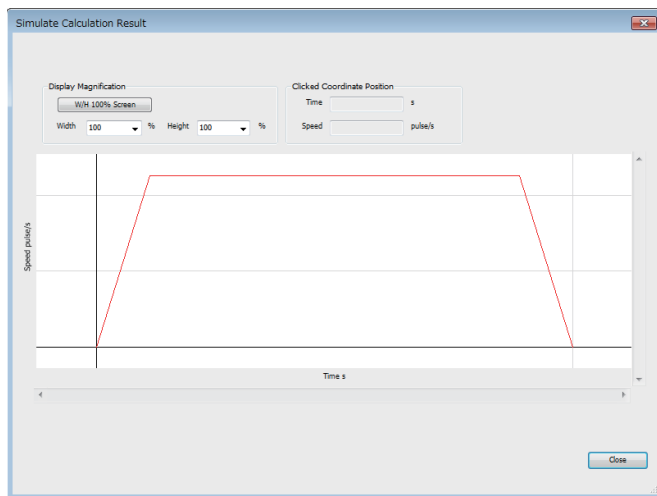

1. Double-click on "Automatic Command Speed Calculation" for the "Axis □ Positioning Data".
2. Set "Positioning Data No." to the positioning data number for which you want to calculate the command speed.
3. Configure the distance of movement, operation time, acceleration time, and deceleration time and then click [Calculate Command Speed] to display the calculation in the "Calculation Result" section. Click [OK] to update the positioning data with the calculated command speed.
4. Once the calculation result is displayed, click [Simulate Calculation Result] to display the waveform based on the calculation result.

Restriction

The automatic command speed calculation can be used for positioning data with the following control methods or without any control method.

- 01H: ABS1 1-axis linear control (ABS)
- 02H: INC1 1-axis linear control (INC)
- 03H: FEED1 1-axis fixed-feed control

Automatic Sub Arc Calculation

The automatic sub arc calculation calculates the sub arc setting value (positioning data) so that the operation (waveform) between two sets of positioning data is smooth. The start point address is determined from the positioning data or the direct address specification.

Setting method



Automatic Sub Arc Calculation

Automatic Sub Arc Calculation

Entry

[Operation Proceeding]
 1. Select a positioning data No. to calculate the sub arc.
 2. Set the PO address (start point) and radius.
 3. Press the Calculate Sub Arc button.

Execute circular interpolation for positioning data No. and positioning data No. 2.
 * If travel distance is short, the curve cannot be smooth.

PO (start point) Address
 Use simulation result
 Directly specify start point address

Reference Axis pulse Interpolation Axis pulse Radius pulse

No.	Axis	Operation pattern	Control system	Axis to be interpolated	Positioning address
P1	#1	L:CONT	DAI:ABS line 2	#2	200 pulse
	#2				400 pulse
P2	#1	O:END	DAI:ABS line 2	#2	2000 pulse
	#2				1000 pulse

Explanation
 Enter the arc radius.
 Having a larger radius allows a shallower curve.
 Range: 1 to 2147483647

Calculate Sub Arc

Calculation Result

No.	Axis	Operation pattern	Control system	Axis to be interpolated	Positioning address	Arc address
1	#1	L:CONT	DAI:ABS line 2	#2	144 pulse	0 pulse
	#2				289 pulse	0 pulse
2	#1	L:CONT	DAI:ABS ArchP	#2	318 pulse	214 pulse
	#2				442 pulse	385 pulse
3	#1	O:END	DAI:ABS line 2	#2	2000 pulse	0 pulse
	#2				1000 pulse	0 pulse

Simulate Calculation Result

Pressing [OK] reflects the data to the positioning data.

OK Cancel

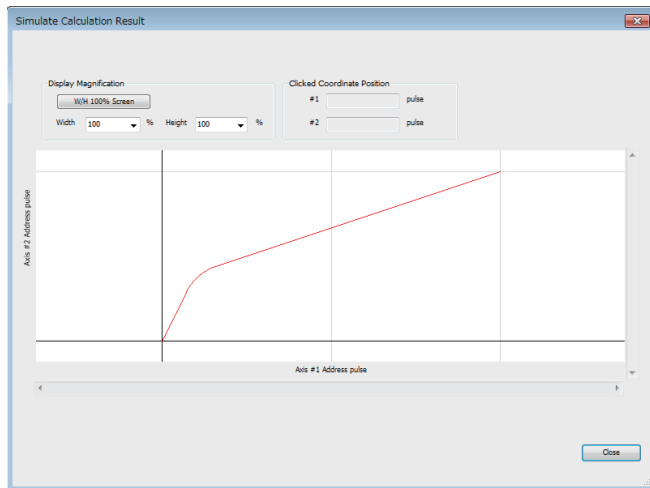

1. Double-click on "Automatic Sub Arc Calculation" for the "Axis Positioning Data".
2. Set "Positioning Data No." to the positioning data number for which you want to calculate the sub arc.*1
3. Configure the radius and then click [Calculate Sub Arc] to display the calculation in the "Calculation Result" section. If using a direct address specification, configure the reference axis and interpolation axis addresses. Click [OK] to update the positioning data with the calculated sub arc setting.
4. Click [Simulate Calculation Result] to display the waveform based on the calculation result.

*1 The automatic calculation cannot be performed when the operation pattern is set to 0: Positioning complete. The end point address is determined by automatic selection of the next specified positioning data number.

Restriction

The following control methods are available for use with Automatic Sub Arc Calculation.

- 0AH: ABS2 2-axis linear interpolation control (ABS)
- 0BH: INC2 2-axis linear interpolation control (INC)
- 0CH: FEED2 Fixed-feed control by 2-axis linear interpolation

Refer to the GX Works3 description for information on other restrictions.

Block start data

Set the block start data number 0 to 4 for each axis.

Item	Setting range	Reference
Shape	<ul style="list-style-type: none"> • 0: Termination • 1: Continue 	Page 435 [Da.11] Shape
Start data No.	1 to 600	Page 436 [Da.12] Start data No.
Special start instruction	<ul style="list-style-type: none"> • 00H: Normal start • 01H: Condition start • 02H: Wait start • 03H: Simultaneous start • 04H: FOR loop • 05H: FOR condition • 06H: NEXT start 	Page 436 [Da.13] Special start instruction
Parameter	<ul style="list-style-type: none"> • 1 to 10 • 0 to 255 	Page 437 [Da.14] Parameter

Condition data

Set condition data for each block start data.

Setting method

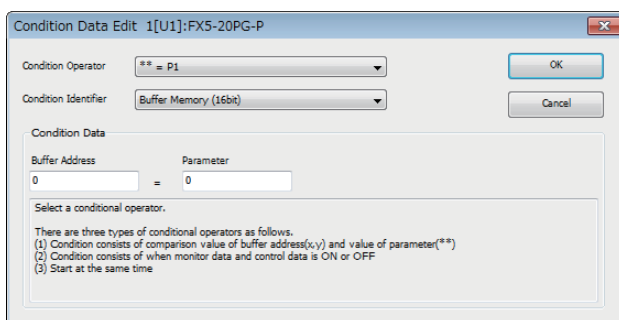
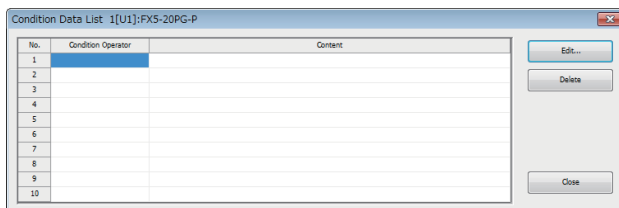
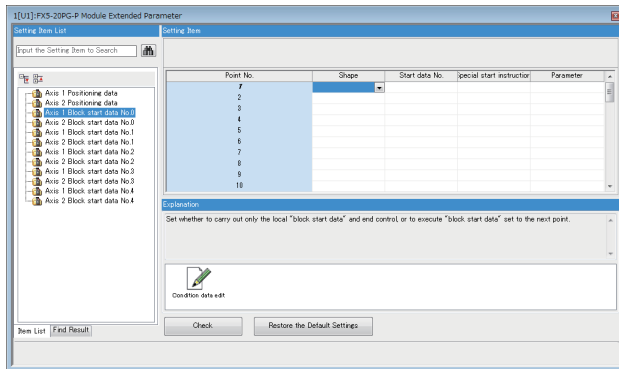

1. Double-click "Condition data edit" in "Axis □ Block start data".
2. Click the cell of the condition data number to be edited and click the [Edit] button.
3. Select settings of "Condition Operator" and "Condition Identifier" from the pull-down menu.
4. Set "Condition Data" according to the condition set in step 3.
5. Click the [OK] button.
6. Click the [Close] button.

■Setting item

Item		Setting range	Reference
Condition Operator		Refer to the right item.	Page 439 [Da.16] Condition operator
Condition Identifier		Refer to the right item.	Page 438 [Da.15] Condition target
Condition data	Buffer address	Refer to the right item.	Page 439 [Da.17] Address
	Parameter	Refer to the right item.	Page 440 [Da.18] Parameter 1
	Monitor Data		Page 441 [Da.19] Parameter 2
	Control Data		
	Axis 1 specification		
	Axis 2 specification		

15 MONITORING/TEST

15.1 Positioning Monitor

With the positioning monitor function, the positioning module operating status can be checked for each axis. The following monitors are available in this function.

Monitor type	Description
Operation monitor	The status of positioning control being performed such as the current feed value and axis feedrate can be checked.
Operation monitor (Axis control)	The status related to axis control can be checked.
Operation monitor (Speed-position switching control)	The status related to speed-position switching control can be monitored.
Operation monitor (Position-speed switching control)	The status related to position-speed switching control can be monitored.
Operation monitor (OPR monitor)	The status related to OPR control can be monitored.
Operation monitor (JOG/manual pulse)	The status related to JOG operation and manual pulse generator operation can be monitored.
Start history	The start history of past 16 records can be monitored.
Error history	The error history of past 16 records can be monitored.
Warning history	The warning history of past 16 records can be monitored.
Module information list	The on/off state of signals and flags of each axis can be checked.

15

How to use

Use the positioning monitor with the following procedure.

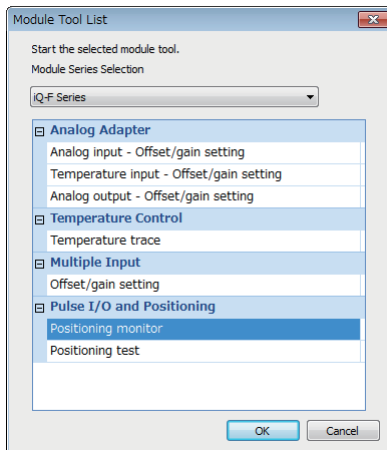

1. Display the "Module Tool List" window and select "Positioning monitor".

[Tool] ⇒ [Module Tool List] ⇒ [Positioning monitor]

2. Select the positioning module being used from the "Module Selection (Positioning monitor)" window and click the [OK] button.

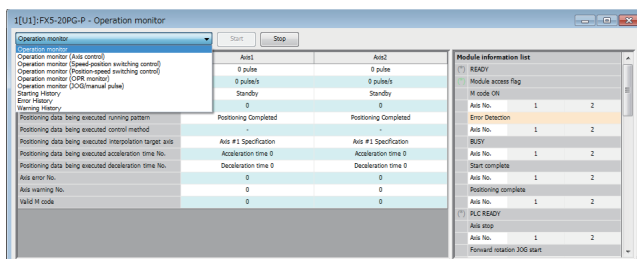

3. Select a monitoring type from the pull-down menu.

"Module Information List" is always displayed on the right of the "Positioning Monitor" window. In "Module Information List", the on state is indicated in color (green) for each axis.

Module information list		
(*) READY		
Module access flag		
M code ON		
Axis No.	1	2
Error Detection		
Axis No.	1	2
BUSY		
Axis No.	1	2
Start complete		
Axis No.	1	2
Positioning complete		
Axis No.	1	2

When an error occurs, the axis in which the error occurs is indicated in orange in "Error Detection". When a warning occurs, the axis in which the warning occurs is indicated in orange in "Status Axis warning detection".

15.2 Positioning Test

This function allows users to perform the following tests while the users monitor the current status of the positioning module.

- Positioning control test
- JOG/manual pulse generator/OPR test
- Speed change test
- Other control tests

Precautions

Before the positioning test is started, necessary parameters and positioning data must be set and written to the positioning module.

Starting method

Start "Positioning test" with the following procedure.

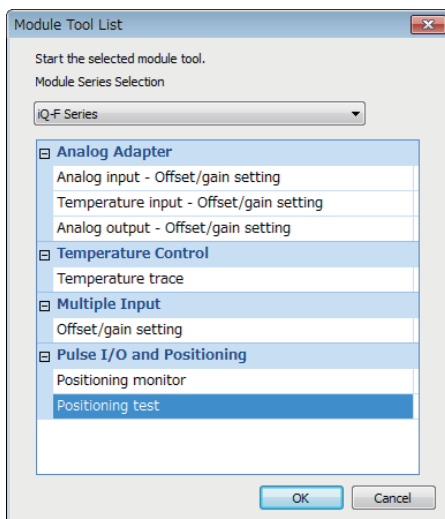

1. Display the "Module Tool List" window and select "Positioning test".
 [Tool] ⇒ [Module Tool List] ⇒ [Positioning test]
2. Select the positioning module being used from the "Module Selection (Positioning Test)" window and click the [OK] button.
3. If external input signals are used for the positioning test, click the [Yes] button. If no external input signal is used for the test, click the [No] button.

Starting window

The following figure and table show the configuration of the "Positioning Test" window.

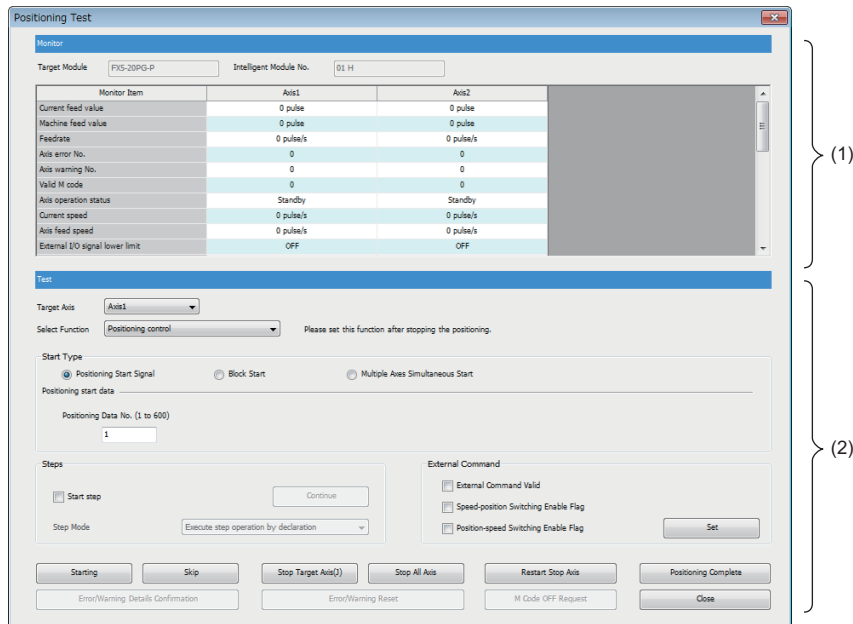

(1) Monitor part

(2) Test part

Button name	Description
Starting	Starts positioning control.
Skip	Performs the skip function to skip the control of the positioning data being performed.
Stop Target Axis	Stops the positioning control of the axis set as the target axis.
Stop All Axis	Stops the positioning control of all the axes.
Restart Stop Axis	Restarts the positioning control that is stopped by the [Stop Target Axis] or [Stop All Axis] button.
Positioning Complete	Ends the positioning control. When the [Positioning Complete] button is clicked and the [Starting] button is clicked, the positioning control is started from the first.
Error/Warning Details Confirmation	Displays the description and corrective action of the errors and warnings that occurred.
Error/Warning Reset	Resets the errors and warnings that occurred.
M Code OFF Request	Turns off M code ON signal.
Close	Closes the "Positioning Test" window.

After starting the operation, perform the positioning test according to each positioning test procedure described as follows.

- Page 342 Positioning control test
- Page 344 JOG/manual pulse generator/OPR test
- Page 347 Speed change test
- Page 349 Other control tests

Positioning control test

Specify a positioning data No. or point No. of block start data to perform the test operation.

1. Select a target axis to be tested from the pull-down menu of "Target Axis".

The screenshot shows the 'Test' dialog box with the following settings: 'Target Axis' is set to 'Axis1', 'Select Function' is set to 'Axis2', and 'Positioning Data No.' is set to '1'. The 'Start Type' section has three radio buttons: 'Positioning Start Signal' (selected), 'Block Start', and 'Multiple Axes Simultaneous Start'. A note next to 'Select Function' says 'Please set this function after stopping the positioning.'

2. Select "Positioning control" from the pull-down menu of "Select Function".

The screenshot shows the 'Test' dialog box with the 'Select Function' dropdown menu open. The menu options are 'Positioning control', 'JOG/Manual Pulse Generator/OPR', 'New Speed', and 'Other control'. 'Positioning control' is highlighted. The other settings remain the same as in the previous screenshot.

3. Select a control method from "Start Type".
4. Set "Positioning start data" according to the selected control method.
 - Positioning start: Positioning data No.
 - Block start: Block No. and Point No.
 - Multiple axes simultaneous start: Multiple axes simultaneous start data No.

The screenshot shows the 'Test' dialog box with the following settings: 'Target Axis' is 'Axis1', 'Select Function' is 'Positioning control', and 'Positioning Data No.' is '1'. The 'Start Type' section has three radio buttons: 'Positioning Start Signal' (selected), 'Block Start', and 'Multiple Axes Simultaneous Start'. The note next to 'Select Function' is still present.

5. Click the [Starting] button to start the test operation.
6. After the test is completed, click the [Positioning Complete] button, then click the [Close] button.

Point

- To stop the positioning control being performed, click the [Stop Target Axis] button or the [Stop All Axis] button.
- By clicking the [Skip] button, the positioning control being performed can be skipped and the next positioning control is started.

■Performing the positioning control test with the step operation

In the positioning control test, positioning control can be performed with the step operation.

1. Before clicking the [Starting] button, select "Start step".
2. Select a step mode from the pull-down menu of "Step Mode".

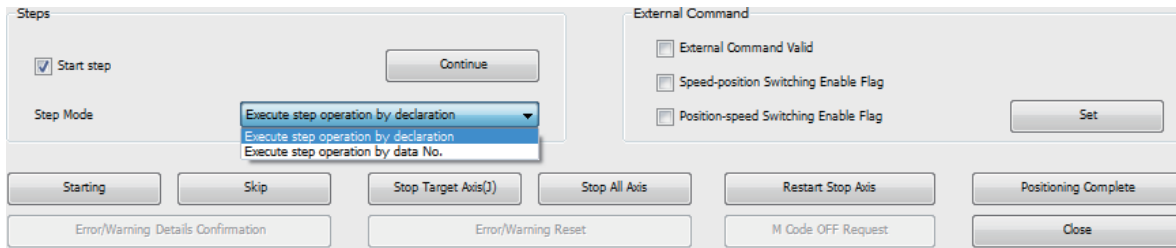

3. Click the [Starting] button to start the test operation.
4. When one step is completed, the positioning control stops. To continue the step operation after the stop, click the [Continue] button.

■Performing the positioning control test with External command signal (CHG)

In the positioning control test, the operation can be started or skipped with External command signal (CHG).

1. Set the external command function selection before starting "Positioning Test".
2. When starting "Positioning Test", click the [Yes] button in the following window.

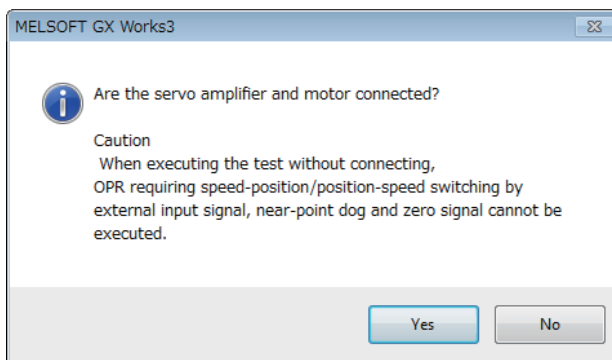

3. Select "External Command Valid" in "External Command". To switch the positioning control between the speed control and position control during the speed-position switching control or position-speed switching control with External command signal (CHG), select "Speed-position Switching Enable Flag" and "Position-speed Switching Enable Flag".

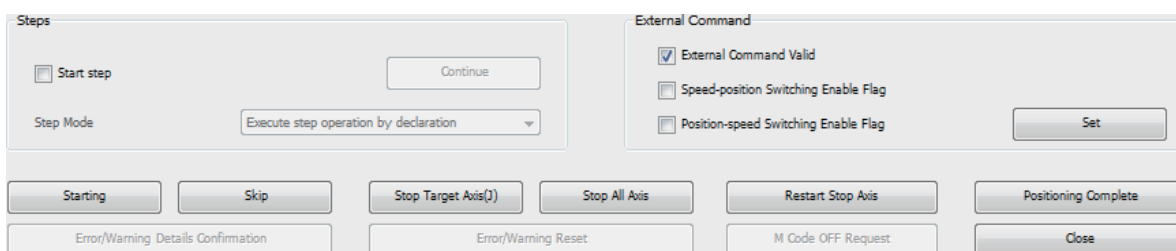

4. Click the [Set] button. The setting in the previous step is reflected to the positioning module.
5. By inputting External command signal (CHG), the start or the skip function can be performed.

JOG/manual pulse generator/OPR test

The following tests can be performed with the JOG operation or manual pulse generator operation when the positioning control is debugged.

- Checking the forward run/reverse run direction
- Checking the on/off state of external input signals such as an upper/lower limit switch, Zero signal, and Near-point dog signal
- Operation test of speed and acceleration/deceleration
- Measuring the backlash compensation amount by the forward run/reverse run
- Measuring the accurate address and movement amount

An OP can be established by performing the OPR test and operation can be checked by set OPR basic parameters and OPR detailed parameters.

■JOG operation

1. Select a target axis to be tested from the pull-down menu of "Target Axis".

The screenshot shows the 'Test' window with the following settings: 'Target Axis' is set to 'Axis1', 'Select Function' is set to 'JOG/Manual Pulse Generator/OPR', 'JOG Speed' is set to 1 pulse/s (1 to 1000000), and 'Inching Movement Amount' is set to 0 pulse (0 to 65535). The 'Forward RUN' and 'Reverse RUN' buttons are visible.

2. Select "JOG/Manual Pulse Generator/OPR" from the pull-down menu of "Select Function".

The screenshot shows the 'Test' window with the 'Select Function' dropdown menu open, displaying options: 'Positioning control', 'JOG/Manual Pulse Generator/OPR', 'New Speed', and 'Other control'. 'JOG/Manual Pulse Generator/OPR' is selected. The other settings are the same as in the previous screenshot.

3. Set "JOG Speed".
4. Set 0 for "Inching Movement Amount".
5. Click the [Forward RUN] button or [Reverse RUN] button to start the test for the JOG operation.

Point

When a value other than 0 is set for "Inching Movement Amount", the test is available with the inching operation.

Manual pulse generator operation

1. Select a target axis to be tested from the pull-down menu of "Target Axis".

The screenshot shows the 'Test' window with the following settings:

- Target Axis:** Axis1
- Select Function:** JOG/Manual Pulse Generator/OPR
- JOG Speed:** 1 pulse/s (1 to 1000000)
- Inching Movement Amount:** 0 pulse (0 to 65535)

Buttons for 'Forward RUN' and 'Reverse RUN' are visible on the right side.

2. Select "JOG/Manual Pulse Generator/OPR" from the pull-down menu of "Select Function".

The screenshot shows the 'Test' window with the 'Select Function' dropdown menu open. The selected option is 'JOG/Manual Pulse Generator/OPR'. Other options visible in the menu include 'Positioning control', 'New Speed', and 'Other control'.

3. Set "Manual Pulse 1 Pulse Generator Input Magnification".

The screenshot shows the 'Manual Pulse Generator' and 'OPR Operation' settings:

- Manual Pulse Generator:**
 - Manual pulse generator enable flag
 - Manual Pulse 1 Pulse Generator Input Magnification: 100 x (1 to 1000)
- OPR Operation:**
 - OPR Method: Machine OPR

Buttons for 'OPR', 'Starting', 'Skip', 'Stop Target Axis(J)', 'Stop All Axis', 'Restart Stop Axis', 'Positioning Complete', 'Error/Warning Details Confirmation', 'Error/Warning Reset', 'M Code OFF Request', and 'Close' are visible at the bottom.

4. Select "Manual pulse generator enable flag".
5. The test for manual pulse generator operation starts using the manual pulse generator connected to the positioning module.

■OPR control

1. Select a target axis to be tested from the pull-down menu of "Target Axis".

The screenshot shows the 'Test' window with the following settings: 'Target Axis' is set to 'Axis1', 'Select Function' is set to 'Motor/OPR', 'JOG Speed' is set to '1 pulse/s (1 to 1000000)', and 'Inching Movement Amount' is set to '0 pulse (0 to 65535)'. There are 'Forward RUN' and 'Reverse RUN' buttons.

2. Select "JOG/Manual Pulse Generator/OPR" from the pull-down menu of "Select Function".

The screenshot shows the 'Test' window with the 'Select Function' dropdown menu open. The menu options are: 'JOG/Manual Pulse Generator/OPR', 'Positioning control', 'JOG/Manual Pulse Generator/OPR', 'New Speed', and 'Other control'. The 'JOG/Manual Pulse Generator/OPR' option is selected. The other settings and buttons are the same as in the previous screenshot.

3. Select "Machine OPR" or "Fast OPR" from the pull-down menu of "OPR Method".

The screenshot shows the 'OPR Operation' window. The 'OPR Method' dropdown menu is open, showing 'Machine OPR', 'Machine OPR', and 'Fast OPR'. The 'OPR' button is visible. Below the dropdown menu are several buttons: 'Starting', 'Skip', 'Stop Target Axis()', 'Stop All Axis', 'Restart Stop Axis', 'Positioning Complete', 'Error/Warning Details Confirmation', 'Error/Warning Reset', 'M Code OFF Request', and 'Close'.

4. Click the [OPR] button.

Point

The on state of Near-point dog signal, Zero signal, and OPR complete flag can be checked on the monitor part. Check the OPR completion on the monitor.

Speed change test

For the axes started with the positioning start test, OPR test, and JOG operation test, perform the speed change function, acceleration/deceleration time change function, or override function to check the proper speed or acceleration/deceleration time.

■Speed change

1. Select a target axis to be tested from the pull-down menu of "Target Axis".

The screenshot shows the 'Test' interface with the following settings: 'Target Axis' is set to 'Axis1', 'Select Function' is set to 'Axis2', and 'New Speed Value' is set to 0. A 'New Speed' button is visible on the right.

2. Select "New Speed" from the pull-down menu of "Select Function".

The screenshot shows the 'Test' interface with the 'Select Function' dropdown menu open. The menu options are 'New Speed', 'Positioning control', 'JOG/Manual Pulse Generator/OPR', and 'Other control'. 'New Speed' is selected. The 'New Speed Value' is still 0.

3. Set "New Speed Value".

The screenshot shows the 'Test' interface with 'New Speed Value' set to 20000. The 'Select Function' is still 'New Speed'.

4. Click the [New Speed] button. The set value of "New Speed Value" is reflected to the positioning control being performed.

■Override function

1. Select a target axis to be tested from the pull-down menu of "Target Axis".

The screenshot shows the 'Test' interface with the following settings: 'Target Axis' is set to 'Axis1', 'Select Function' is set to 'Axis2', and 'New Speed Value' is set to 0. A 'New Speed' button is visible on the right.

2. Select "New Speed" from the pull-down menu of "Select Function".

The screenshot shows the 'Test' interface with the 'Select Function' dropdown menu open. The menu options are 'New Speed', 'Positioning control', 'JOG/Manual Pulse Generator/OPR', and 'Other control'. 'New Speed' is selected. The 'New Speed Value' is still 0.

3. Set "Speed Override".

New Speed

New Speed Value 0 pulse/s (0 to 1000000) New Speed

Override

Speed Override 200 % (0 to 300) Speed Override Change

Acceleration/Deceleration Time Change

Acceleration/deceleration time change enable

Acceleration Time 0 ms (0 to 8388608)

Deceleration Time 0 ms (0 to 8388608)

4. Click the [Speed Override Change] button. The set value of "Speed Override" is reflected to the positioning control being performed.

■Acceleration/deceleration time change

1. Select a target axis to be tested from the pull-down menu of "Target Axis".

Test

Target Axis Axis1

Select Function Axis2 Please set this function after stopping the positioning.

New Speed

New Speed Value 0 pulse/s (0 to 1000000) New Speed

2. Select "New Speed" from the pull-down menu of "Select Function".

Test

Target Axis Axis1

Select Function New Speed Please set this function after stopping the positioning.

New Speed

New Speed Value 0 pulse/s (0 to 1000000) New Speed

3. Select "Acceleration/deceleration time change enable".

4. Set "Acceleration Time" and "Deceleration Time".

Acceleration/Deceleration Time Change

Acceleration/deceleration time change enable

Acceleration Time 100 ms (0 to 8388608)

Deceleration Time 50 ms (0 to 8388608)

Starting Skip Stop Target Axis(J) Stop All Axis Restart Stop Axis Positioning Complete

Error/Warning Details Confirmation Error/Warning Reset M Code OFF Request Close

5. Click the [New Speed] button. The set values of "Acceleration Time" and "Deceleration Time" are reflected to the positioning control being performed.

Other control tests

Change the current feed value of the positioning module to a specified address.

1. Select a target axis to be tested from the pull-down menu of "Target Axis".

The screenshot shows the 'Test' interface with the following settings:

- Target Axis: Axis1
- Select Function: Axis2
- New Current Value: 0
- Unit: pulse (-2147483648 to 2147483647)
- Button: Current Value Changing

2. Select "Other control" from the pull-down menu of "Select Function".

The screenshot shows the 'Test' interface with the 'Select Function' dropdown menu open. The options are:

- Other control (selected)
- Positioning control
- JOG/Manual Pulse Generator/OPR
- New Speed
- Other control

The 'New Current Value' field is currently empty.

3. Set "New Current Value".

The screenshot shows the 'Test' interface with the following settings:

- Target Axis: Axis1
- Select Function: Other control
- New Current Value: 20000
- Unit: pulse (-2147483648 to 2147483647)
- Button: Current Value Changing

4. Click the [Current Value Changing] button. The set value of "New Current Value" is reflected to "Current feed value".

16 SPECIFICATIONS OF I/O SIGNALS WITH CPU MODULE

16.1 List of I/O Signals with CPU Module

The positioning module uses buffer memory for transfers of data with the CPU module. The following shows the list of I/O signals for positioning module.

Input signal

Buffer memory address	Signal name	
31500.b0	READY	
31500.b1	Module access flag	
817.b12	Axis 1	M code ON
917.b12	Axis 2	
817.b13	Axis 1	Error detection
917.b13	Axis 2	
31501	—	BUSY
31501.b0	Axis 1	
31501.b1	Axis 2	
817.b14	Axis 1	Start complete
917.b14	Axis 2	
817.b15	Axis 1	Positioning complete
917.b15	Axis 2	

Output signal

Buffer memory address	Signal name	
1950	PLC READY	
30100	Axis 1	Axis stop
30110	Axis 2	
30101	Axis 1	Forward run JOG start
30102	Axis 1	Reverse run JOG start
30111	Axis 2	Forward run JOG start
30112	Axis 2	Reverse run JOG start
30104.b0	Axis 1	Positioning start
30114.b0	Axis 2	
30103	Axis 1	Execution prohibition flag
30113	Axis 2	

16.2 Details of Input Signals

The following tables shows the ON/OFF timing and conditions of the input signals.

Buffer memory address	Signal name		Description
31500.b0	READY		<p>ON: READY OFF: Not READY/ Watchdog timer error</p> <ul style="list-style-type: none"> When [Cd.190] PLC READY signal is turned off and on, the parameter setting range is checked. If no error is found, this signal turns on. When [Cd.190] PLC READY signal is turned off, this signal turns off. When a watchdog timer error occurs, this signal turns off. This signal is used for interlock in a program and others. <p>[Cd.190] PLC READY signal</p> <p>READY signal ([Md.140] Module status: b0)</p>
31500.b1	Module access flag		<p>OFF: Module access disabled ON: Module access enabled</p> <ul style="list-style-type: none"> After the CPU module is set to RUN, this signal turns on with the status that allows the access from the CPU module to the positioning module. This signal turns off while the CPU module is in the STOP status. This signal is used for interlock in a program and others.
817.b12 917.b12	Axis 1 Axis 2	M code ON	<p>OFF: M code is not set ON: M code is set</p> <ul style="list-style-type: none"> In the WITH mode, this signal turns on when the positioning data operation is started. In the AFTER mode, this signal turns on when the positioning data operation is completed. This signal turns off with [Cd.7] M code ON signal OFF request. When no M code is specified (When [Da.10] M code is 0), this signal remains off. With using continuous path control for the positioning operation, the positioning continues even when this signal does not turn off. However, M code ON signal ON (Warning code: 0992H) will occur. When [Cd.190] PLC READY signal is turned off, this signal also turns off. If the operation is started while the M code is on, M code ON signal ON start (Error code: 19A0H) will occur.
817.b13 917.b13	Axis 1 Axis 2	Error detection	<p>OFF: No error ON: Error</p> <ul style="list-style-type: none"> This signal turns on when an error occurs, and turns off when the error is reset on [Cd.5] Axis error reset.
31501.b0 31501.b1	Axis 1 Axis 2	BUSY ^{*1}	<p>OFF: Not BUSY ON: BUSY</p> <ul style="list-style-type: none"> This signal turns on at the start of the positioning, OPR, or JOG operation. This signal turns off when the time set in [Da.9] Dwell time has passed after the positioning operation stops. (This signal remains on during positioning.) This signal turns off when the positioning is stopped with step operation. During manual pulse generator operation, this signal turns on while [Cd.21] Manual pulse generator enable flag is on. This signal turns off at error completion or positioning stop.
817.b14 917.b14	Axis 1 Axis 2	Start complete	<p>OFF: Start incomplete ON: Start complete</p> <ul style="list-style-type: none"> This signal turns on when the positioning module starts the positioning processing since Positioning start signal is turned on. (Start complete signal also turns on during OPR control.) <p>[Cd.184] Positioning start signal</p> <p>Start complete signal ([Md.31] Status: b14)</p>
817.b15 917.b15	Axis 1 Axis 2	Positioning complete ^{*2}	<p>OFF: Positioning incomplete ON: Positioning complete</p> <ul style="list-style-type: none"> This signal turns on for the time set in [Pr.40] Positioning complete signal output time from the instant when the positioning control for each positioning data No. is completed. For the interpolation control, Positioning complete signal of the interpolation axis turns on for the time set to the reference axis. (This signal does not turn on when [Pr.40] Positioning complete signal output time is 0.) This signal will turn off if the positioning (including OPR), JOG operation, inching operation, or manual pulse generator operation is started while this signal is on. This signal will not turn on when the speed control or positioning is canceled midway.

*1 BUSY signal turns on even when the position control of a movement amount 0 is executed. However, since the ON time is short, the ON status may not be detected in the program.

*2 Positioning complete of the positioning module refers to the point when the pulse output from the positioning module is completed. Thus, even if Positioning complete signal of the positioning module turns on, the system may continue operation.

16.3 Details of Output Signals

The following tables shows the ON/OFF timing and conditions of the output signals.

Buffer memory address	Signal name		Description
1950	PLC READY		<ul style="list-style-type: none"> • Other than 1: PLC READY OFF • 1: PLC READY ON <p>(a) This signal notifies the positioning module that the CPU module is normal.</p> <ul style="list-style-type: none"> • This signal is turned on and off with the program. • This signal is turned on during the positioning control, OPR control, JOG operation, inching operation, and manual pulse generator operation, unless the system is in the GX Works3 test mode. <p>(b) When data (including parameter) has been changed, this signal is turned off depending on the changed item.</p> <p>(c) The following processing is performed when this signal is turned off and on.</p> <ul style="list-style-type: none"> • The parameter setting range is checked. • Check that READY signal ([Md.140] Module status: b0) is on. <p>(d) The following processing is performed when this signal is turned on and off.</p> <p>In this case, the OFF time should be set to 100 ms or more.</p> <ul style="list-style-type: none"> • Check that READY signal ([Md.140] Module status: b0) is off. • The operating axis stops. • M code ON signal ([Md.31] Status: b12) for each axis turns off, and 0 is stored in [Md.25] Valid M code. <p>(e) When the module data backup or module data initialization is performed with GX Works3 or the CPU module, turn off this signal.</p>
30100 30110	Axis 1 Axis 2	Axis stop	<ul style="list-style-type: none"> • Other than 1: No axis stop request • 1: Axis stop request <ul style="list-style-type: none"> • When Axis stop signal is turned on, the OPR control, positioning control, JOG operation, inching operation, and manual pulse generator operation will stop. • By turning on this signal during the positioning operation, the operation will be stopped. • Whether to decelerate or suddenly stop can be selected with [Pr.39] Stop group 3 sudden stop selection. • During the interpolation control of the positioning operation, if this signal of any axis is turned on, all axes in the interpolation control will decelerate and stop.
30101 30102 30111 30112	Axis 1 Axis 1 Axis 2 Axis 2	Forward run JOG start Reverse run JOG start Forward run JOG start Reverse run JOG start	<ul style="list-style-type: none"> • Other than 1: JOG not started • 1: JOG started <ul style="list-style-type: none"> • When this signal is on, the JOG operation will be performed with [Cd.17] JOG speed. When this signal is turned off, the operation will decelerate and stop. • When an inching movement amount is set, the specified movement amount is output for one control cycle and the operation stops.
30104.b0 30114.b0	Axis 1 Axis 2	Positioning start	<ul style="list-style-type: none"> • OFF: No positioning start request • ON: Positioning start request <ul style="list-style-type: none"> • The OPR operation or positioning operation is started. • Positioning start signal is valid at the rising edge, and the operation is started. • When this signal is turned on during BUSY, Start during operation (Warning code: 0900H) will occur.
30103 30113	Axis 1 Axis 2	Execution prohibition flag	<ul style="list-style-type: none"> • Other than 1: Not during execution prohibition • 1: During execution prohibition <ul style="list-style-type: none"> • If this signal is on when Positioning start signal is turned on, the positioning control does not start until this signal is turned off. (pulses not output) This signal is used with Pre-reading start function.

16.4 I/O Signals Allocation of Module Diagnostic

By using module diagnostics of GX Works3, check the I/O signals status of positioning module.
Specifications of I/O signals is shown below.

Input signal			
Input signal 1		Input signal 2	
b0	READY	b0	Start complete (Axis 1)
b1	Module access flag	b1	Start complete (Axis 2)
b2	Use prohibited (fixed to 0)	b2	Use prohibited (fixed to 0)
b3		b3	
b4	M code ON (Axis 1)	b4	Positioning complete (Axis 1)
b5	M code ON (Axis 2)	b5	Positioning complete (Axis 2)
b6	Use prohibited (fixed to 0)	b6	Use prohibited (fixed to 0)
b7		b7	
b8	Error detection (Axis 1)	b8	
b9	Error detection (Axis 2)	b9	
b10	Use prohibited (fixed to 0)	b10	
b11		b11	
b12	BUSY (Axis 1)	b12	
b13	BUSY (Axis 2)	b13	
b14	Use prohibited (fixed to 0)	b14	
b15		b15	

Output signal			
Output signal 1		Output signal 2	
b0	PLC READY	b0	Positioning start (Axis 1)
b1	Use prohibited (fixed to 0)	b1	Positioning start (Axis 2)
b2		b2	Use prohibited (fixed to 0)
b3		b3	
b4	Axis stop (Axis 1)	b4	Implementation prohibition (Axis 1)
b5	Axis stop (Axis 2)	b5	Implementation prohibition (Axis 2)
b6	Use prohibited (fixed to 0)	b6	Use prohibited (fixed to 0)
b7		b7	
b8	Forward JOG start (Axis 1)	b8	
b9	Reverse JOG start (Axis 1)	b9	
b10	Forward JOG start (Axis 2)	b10	
b11	Reverse JOG start (Axis 2)	b11	
b12	Use prohibited (fixed to 0)	b12	
b13		b13	
b14		b14	
b15		b15	

17 DATA USED FOR POSITIONING CONTROL

This chapter describes the parameters and data used for performing the positioning control with the positioning module. In the positioning system using the positioning module, the various parameters and data are used for the control. The parameters and data include parameters set according to the device configuration, such as the system configuration, and parameters and data set according to each control.

17.1 Types of Data

Parameters and data required for the control

The parameters and data required to perform the control using the positioning module include Setting data, Monitor data, and Control data shown below.

Setting data

The data is set beforehand according to the machine and application. Set the data with programs or GX Works3. The data set for the buffer memory can also be saved in the flash ROM in the positioning module.

The setting data is classified as follows.

Classification		Item	Description
Module parameter	Basic setting	Basic parameter 1	Set the parameter according to the machine and applicable motor at the system start-up.
		Basic parameter 2	
		Detailed parameter 1	Set the parameter according to the system configuration at the system start-up.
		Detailed parameter 2	
		OPR basic parameter	Set the required values for performing the OPR control.
	OPR detailed parameter		
Interrupt setting	Interrupt setting data	Set the setting data for the interrupt function.	
Module extension parameter	Positioning data	Positioning data	Set the data for the major positioning control.
	Block start data	Block start data	Set the block start data for the advanced positioning control.
		Condition data	Set the condition data for the advanced positioning control.

Valid timing of setting data

The following table lists the timings when each type of data is validated.

Valid timing	Applicable data	Description
[Cd.190] PLC READY signal transitions from off to on.	Basic parameter 1 Detailed parameter 1 OPR basic parameter OPR detailed parameter Interrupt setting data	The only valid value of [Pr.5] Pulse output mode is the value at the moment when [Cd.190] PLC READY signal is turned off and on for the first time after the power is switched on or the CPU module is reset.
When the positioning starts	Basic parameter 2 Detailed parameter 2 Positioning data Block start data	Once the operation has started, any modification to the data is ignored in the control. The modification is valid at the next positioning start. Exceptionally, however, modifications to the following data are valid even during positioning. <ul style="list-style-type: none"> Acceleration time 0 to 3 and deceleration time 0 to 3: Positioning data are pre-read and pre-analyzed. Modifications to the data four or more steps after the current step are valid. [Pr.42] External command function selection: The value at the time of detection is valid. When the multiple positioning data are continuously processed by using the continuous positioning control or continuous path control, modifications to the data four or more steps after the current step are valid. Modifications to the data three or less steps before the current step may be invalid because the positioning data are pre-read and pre-analyzed.

Monitor Data

The data indicates the control status. The data is stored in the buffer memory. Monitor the data as necessary.

The setting data is classified as follows.

Item	Description
System monitor	Monitors the positioning module specifications and the operation history.
Axis monitor data	Monitors the data related to the operating axis, such as the current position and speed.

Control Data

The data is used by users to control the positioning system.

The setting data is classified as follows.

Item	Description
System control data	Backs up the setting data of the positioning module or initializes the backup data.
Axis control data	Configures the settings related to the operation, controls the speed change during operation, and stops or restarts the operation.

■Data setting timing

- The control using the control data is performed with programs.
- [Cd.41] Deceleration start flag valid is valid for only the value of when [Cd.190] PLC READY signal is turned off and on.

Point

- Setting data is created for each axis.
- The initial values are determined for the parameters of Setting data, and are set as the factory default. (The parameters related to axes that are not used are left at the initial values.)
- Setting data can be initialized with programs.
- Setting of Setting data with GX Works3 is recommended. The program for the setting is complicated and many devices must be used. This will increase the scan time.

Setting items for positioning parameters

The following table lists the setting items for Positioning parameter. For Positioning parameter, set the same setting for all controls using the positioning module for each axis.

OPR control

◎: Always set

○: Set as required

△: Setting restricted

—: Setting not required (Because this item is an irrelevant item, the set value is ignored. Set the value within the setting range, such as the initial value.)

Positioning parameter	OPR control
■Basic parameter 1	
[Pr.1] Unit setting	◎
[Pr.2] No. of pulses per rotation	◎
[Pr.3] Movement amount per rotation	◎
[Pr.4] Unit magnification	◎
[Pr.5] Pulse output mode	◎
[Pr.6] Rotation direction setting	◎
[Pr.7] Bias speed at start	○
[Pr.62] Electronic gear selection	◎
■Basic parameter 2	
[Pr.8] Speed limit value	◎
[Pr.9] Acceleration time 0	◎
[Pr.10] Deceleration time 0	◎
■Detailed parameter 1	
[Pr.11] Backlash compensation amount	○
[Pr.12] Software stroke limit upper limit value	—
[Pr.13] Software stroke limit lower limit value	—
[Pr.14] Software stroke limit selection	—
[Pr.15] Software stroke limit valid/invalid setting	—
[Pr.16] Command in-position width	—
[Pr.17] Torque limit setting value	△
[Pr.18] M code ON signal output timing	—
[Pr.19] Speed switching mode	—
[Pr.20] Interpolation speed specification method	—
[Pr.21] Current feed value during speed control	—
[Pr.22] Input signal logic selection	◎
[Pr.23] Output signal logic selection	◎
[Pr.24] Manual pulse generator input selection	—
■Detailed parameter 1	
[Pr.150] Speed-position function selection	—
■Detailed parameter 2	
[Pr.25] Acceleration time 1	◎
[Pr.26] Acceleration time 2	◎
[Pr.27] Acceleration time 3	◎
[Pr.28] Deceleration time 1	○
[Pr.29] Deceleration time 2	—
[Pr.30] Deceleration time 3	—
[Pr.31] JOG speed limit value	—
[Pr.32] JOG operation acceleration time selection	—
[Pr.33] JOG operation deceleration time selection	—
[Pr.34] Acceleration/deceleration processing selection	△
[Pr.35] S-curve ratio	—
[Pr.36] Sudden stop deceleration time	—

Positioning parameter	OPR control
[Pr.37] Stop group 1 sudden stop selection	—
[Pr.38] Stop group 2 sudden stop selection	—
[Pr.39] Stop group 3 sudden stop selection	⊙
[Pr.40] Positioning complete signal output time	⊙
[Pr.41] Allowable circular interpolation error width	—
[Pr.42] External command function selection	—
[Pr.82] Start adjustment time	—

Major positioning control

- ⊙: Always set
- : Set as required
- △: Setting restricted
- : Setting not required (Because this item is an irrelevant item, the set value is ignored. Set the value within the setting range, such as the initial value.)

Positioning parameter	Position control			Axis speed control
	1-axis linear control 2-axis linear interpolation control	Fixed-feed control	2-axis circular interpolation control	
■Basic parameter 1				
[Pr.1] Unit setting	⊙	⊙	△	⊙
[Pr.2] No. of pulses per rotation	⊙	⊙	⊙	⊙
[Pr.3] Movement amount per rotation	⊙	⊙	⊙	⊙
[Pr.4] Unit magnification	⊙	⊙	⊙	⊙
[Pr.5] Pulse output mode	⊙	⊙	⊙	⊙
[Pr.6] Rotation direction setting	⊙	⊙	⊙	⊙
[Pr.7] Bias speed at start	○	○	○	○
[Pr.62] Electronic gear selection	⊙	⊙	⊙	⊙
■Basic parameter 2				
[Pr.8] Speed limit value	⊙	⊙	⊙	⊙
[Pr.9] Acceleration time 0	⊙	⊙	⊙	⊙
[Pr.10] Deceleration time 0	⊙	⊙	⊙	⊙
■Detailed parameter 1				
[Pr.11] Backlash compensation amount	○	○	○	○
[Pr.12] Software stroke limit upper limit value	○	○	○	○
[Pr.13] Software stroke limit lower limit value	○	○	○	○
[Pr.14] Software stroke limit selection	○	○	○	○
[Pr.15] Software stroke limit valid/invalid setting	—	—	—	—
[Pr.16] Command in-position width	○	○	○	—
[Pr.17] Torque limit setting value	○	○	○	○
[Pr.18] M code ON signal output timing	○	○	○	○
[Pr.19] Speed switching mode	○	○	○	—
[Pr.20] Interpolation speed specification method	△	△	△	△
[Pr.21] Current feed value during speed control	—	—	—	○
[Pr.22] Input signal logic selection	⊙	⊙	⊙	⊙
[Pr.23] Output signal logic selection	⊙	⊙	⊙	⊙
[Pr.24] Manual pulse generator input selection	—	—	—	—
[Pr.150] Speed-position function selection	—	—	—	—
■Detailed parameter 2				
[Pr.25] Acceleration time 1	○	○	○	○
[Pr.26] Acceleration time 2	○	○	○	○
[Pr.27] Acceleration time 3	○	○	○	○
[Pr.28] Deceleration time 1	○	○	○	○
[Pr.29] Deceleration time 2	○	○	○	○

Positioning parameter	Position control			Axis speed control
	1-axis linear control 2-axis linear interpolation control	Fixed-feed control	2-axis circular interpolation control	
[Pr.30] Deceleration time 3	<input type="radio"/>	<input type="radio"/>	<input type="radio"/>	<input type="radio"/>
[Pr.31] JOG speed limit value	—	—	—	—
[Pr.32] JOG operation acceleration time selection	—	—	—	—
[Pr.33] JOG operation deceleration time selection	—	—	—	—
[Pr.34] Acceleration/deceleration processing selection	<input type="radio"/>	<input type="radio"/>	<input type="radio"/>	<input type="radio"/>
[Pr.35] S-curve ratio	<input type="radio"/>	<input type="radio"/>	<input type="radio"/>	<input type="radio"/>
[Pr.36] Sudden stop deceleration time	<input type="radio"/>	<input type="radio"/>	<input type="radio"/>	<input type="radio"/>
[Pr.37] Stop group 1 sudden stop selection	<input type="radio"/>	<input type="radio"/>	<input type="radio"/>	<input type="radio"/>
[Pr.38] Stop group 2 sudden stop selection	<input type="radio"/>	<input type="radio"/>	<input type="radio"/>	<input type="radio"/>
[Pr.39] Stop group 3 sudden stop selection	<input type="radio"/>	<input type="radio"/>	<input type="radio"/>	<input type="radio"/>
[Pr.40] Positioning complete signal output time	<input type="radio"/>	<input type="radio"/>	<input type="radio"/>	<input type="radio"/>
[Pr.41] Allowable circular interpolation error width	—	—	<input type="radio"/>	—
[Pr.42] External command function selection	<input type="radio"/>	<input type="radio"/>	<input type="radio"/>	<input type="radio"/>
[Pr.82] Start adjustment time	<input type="radio"/>	<input type="radio"/>	<input type="radio"/>	<input type="radio"/>

Positioning parameter	Speed-position or position-speed switching control	Other controls	
		Current value change	JUMP instruction, NOP instruction LOOP to LEND

■Basic parameter 1

[Pr.1] Unit setting	<input checked="" type="radio"/>	<input checked="" type="radio"/>	<input checked="" type="radio"/>
[Pr.2] No. of pulses per rotation	<input checked="" type="radio"/>	<input checked="" type="radio"/>	<input checked="" type="radio"/>
[Pr.3] Movement amount per rotation	<input checked="" type="radio"/>	<input checked="" type="radio"/>	<input checked="" type="radio"/>
[Pr.4] Unit magnification	<input checked="" type="radio"/>	<input checked="" type="radio"/>	<input checked="" type="radio"/>
[Pr.5] Pulse output mode	<input checked="" type="radio"/>	<input checked="" type="radio"/>	<input checked="" type="radio"/>
[Pr.6] Rotation direction setting	<input checked="" type="radio"/>	<input checked="" type="radio"/>	<input checked="" type="radio"/>
[Pr.7] Bias speed at start	<input type="radio"/>	—	—
[Pr.62] Electronic gear selection	<input checked="" type="radio"/>	<input checked="" type="radio"/>	<input checked="" type="radio"/>

■Basic parameter 2

[Pr.8] Speed limit value	<input checked="" type="radio"/>	—	—
[Pr.9] Acceleration time 0	<input checked="" type="radio"/>	—	—
[Pr.10] Deceleration time 0	<input checked="" type="radio"/>	—	—

■Detailed parameter 1

[Pr.11] Backlash compensation amount	<input type="radio"/>	—	—
[Pr.12] Software stroke limit upper limit value	<input type="radio"/>	—	—
[Pr.13] Software stroke limit lower limit value	<input type="radio"/>	—	—
[Pr.14] Software stroke limit selection	<input type="radio"/>	—	—
[Pr.15] Software stroke limit valid/invalid setting	—	<input type="radio"/>	<input type="radio"/>
[Pr.16] Command in-position width	<input type="radio"/>	<input type="radio"/>	<input type="radio"/>
[Pr.17] Torque limit setting value	<input type="radio"/>	—	—
[Pr.18] M code ON signal output timing	<input type="radio"/>	<input type="radio"/>	—
[Pr.19] Speed switching mode	—	—	—
[Pr.20] Interpolation speed specification method	—	—	—
[Pr.21] Current feed value during speed control	<input type="radio"/>	—	—
[Pr.22] Input signal logic selection	<input checked="" type="radio"/>	<input checked="" type="radio"/>	<input checked="" type="radio"/>
[Pr.23] Output signal logic selection	<input checked="" type="radio"/>	<input checked="" type="radio"/>	<input checked="" type="radio"/>
[Pr.24] Manual pulse generator input selection	—	—	—

Positioning parameter	Speed-position or position-speed switching control	Other controls	
		Current value change	JUMP instruction, NOP instruction LOOP to LEND
[Pr.150] Speed-position function selection	◎	—	—
■Detailed parameter 2			
[Pr.25] Acceleration time 1	○	—	—
[Pr.26] Acceleration time 2	○	—	—
[Pr.27] Acceleration time 3	○	—	—
[Pr.28] Deceleration time 1	○	—	—
[Pr.29] Deceleration time 2	○	—	—
[Pr.30] Deceleration time 3	○	—	—
[Pr.31] JOG speed limit value	—	—	—
[Pr.32] JOG operation acceleration time selection	—	—	—
[Pr.33] JOG operation deceleration time selection	—	—	—
[Pr.34] Acceleration/deceleration processing selection	○	—	—
[Pr.35] S-curve ratio	○	—	—
[Pr.36] Sudden stop deceleration time	○	—	—
[Pr.37] Stop group 1 sudden stop selection	○	—	—
[Pr.38] Stop group 2 sudden stop selection	○	—	—
[Pr.39] Stop group 3 sudden stop selection	○	—	—
[Pr.40] Positioning complete signal output time	○	○	—
[Pr.41] Allowable circular interpolation error width	—	—	—
[Pr.42] External command function selection	◎	○	—
[Pr.82] Start adjustment time	○	—	—

Manual control

◎: Always set

○: Set as required

△: Setting restricted

—: Setting not required (Because this item is an irrelevant item, the set value is ignored. Set the value within the setting range, such as the initial value.)

Positioning parameter	Manual pulse generator operation	JOG operation Inching operation
■Basic parameter 1		
[Pr.1] Unit setting	◎	◎
[Pr.2] No. of pulses per rotation	◎	◎
[Pr.3] Movement amount per rotation	◎	◎
[Pr.4] Unit magnification	◎	◎
[Pr.5] Pulse output mode	◎	◎
[Pr.6] Rotation direction setting	◎	◎
[Pr.7] Bias speed at start	—	○
[Pr.62] Electronic gear selection	◎	◎
■Basic parameter 2		
[Pr.8] Speed limit value	—	◎
[Pr.9] Acceleration time 0	—	◎
[Pr.10] Deceleration time 0	—	◎
■Detailed parameter 1		
[Pr.11] Backlash compensation amount	○	○
[Pr.12] Software stroke limit upper limit value	○	○
[Pr.13] Software stroke limit lower limit value	○	○
[Pr.14] Software stroke limit selection	○	○
[Pr.15] Software stroke limit valid/invalid setting	○	○

Positioning parameter	Manual pulse generator operation	JOG operation Inching operation
[Pr.16] Command in-position width	○	○
[Pr.17] Torque limit setting value	△	△
[Pr.18] M code ON signal output timing	—	—
[Pr.19] Speed switching mode	—	—
[Pr.20] Interpolation speed specification method	—	—
[Pr.21] Current feed value during speed control	—	—
[Pr.22] Input signal logic selection	◎	◎
[Pr.23] Output signal logic selection	◎	◎
[Pr.24] Manual pulse generator input selection	◎	—
■Detailed parameter 1		
[Pr.150] Speed-position function selection	—	—
■Detailed parameter 2		
[Pr.25] Acceleration time 1	—	◎
[Pr.26] Acceleration time 2	—	◎
[Pr.27] Acceleration time 3	—	◎
[Pr.28] Deceleration time 1	○	○
[Pr.29] Deceleration time 2	○	○
[Pr.30] Deceleration time 3	○	○
[Pr.31] JOG speed limit value	○	○
[Pr.32] JOG operation acceleration time selection	○	○
[Pr.33] JOG operation deceleration time selection	○	○
[Pr.34] Acceleration/deceleration processing selection	△	△
[Pr.35] S-curve ratio	—	—
[Pr.36] Sudden stop deceleration time	—	—
[Pr.37] Stop group 1 sudden stop selection	—	—
[Pr.38] Stop group 2 sudden stop selection	—	—
[Pr.39] Stop group 3 sudden stop selection	◎	◎
[Pr.40] Positioning complete signal output time	◎	◎
[Pr.41] Allowable circular interpolation error width	◎	—
[Pr.42] External command function selection	—	—
[Pr.82] Start adjustment time	—	—

Checking positioning parameters

Positioning parameters are checked at the following timings.

- When [Cd.190] PLC READY signal output from the CPU module to the positioning module changes from off to on
- When the [Start] button is clicked for the "Positioning Test" in GX Works3

Point

Advanced positioning control is performed in combination with Major positioning control. For details on the parameters required for Advanced positioning control, refer to the parameter settings of Major positioning control.

Setting items for OPR parameters

OPR parameters must be set to perform OPR control. The following table lists the setting items for OPR parameter.

For OPR parameter, set the same setting for each axis.

◎: Always set

○: Use parameters set for the machine OPR control

—: Setting not required (Because this item is an irrelevant item, the set value is ignored. Set the value within the setting range, such as the initial value.)

OPR parameter	Machine OPR control					
OPR basic parameter	[Pr.43] OPR method	Near-point dog method	Stopper method 1	Stopper method 2	Stopper method 3	Count method 1
	[Pr.44] OPR direction	◎	◎	◎	◎	◎
	[Pr.45] OP address	◎	◎*1	◎	◎	◎
	[Pr.46] OPR speed	◎	◎	◎	◎	◎
	[Pr.47] Creep speed	◎	◎	◎	◎	◎
	[Pr.48] OPR retry	◎*1	◎*1	◎*1	—	◎*1
OPR detailed parameter	[Pr.49] OPR dwell time	—	◎	—	—	—
	[Pr.50] Setting for the movement amount after near-point dog ON	—	—	—	—	◎
	[Pr.51] OPR acceleration time selection	◎*2	◎	◎	◎	◎
	[Pr.52] OPR deceleration time selection	◎	◎	◎	◎	◎
	[Pr.53] OP shift amount	◎*2	◎*2	◎*2	◎*2	◎*2
	[Pr.54] OPR torque limit value	—	◎	◎	◎	—
	[Pr.55] Deviation counter clear signal output time	◎*3	◎*3	◎*3	◎*3	◎*3
	[Pr.56] Speed specification during OP shift	◎*2	◎*2	◎*2	◎*2	◎*2
	[Pr.57] Dwell time during OPR retry	◎*1	◎*1	◎*1	—	◎*1
	[Pr.58] Setting of operation during uncompleted OPR	◎	◎	◎	◎	◎

OPR parameter	Machine OPR control			Fast OPR control
OPR basic parameter	[Pr.43] OPR method	Count method 2	Data setting method	Limit switch combined-use method
	[Pr.44] OPR direction	◎	—	◎
	[Pr.45] OP address	◎	◎	◎
	[Pr.46] OPR speed	◎	—	◎
	[Pr.47] Creep speed	◎	—	◎
	[Pr.48] OPR retry	◎*1	—	—
OPR detailed parameter	[Pr.49] OPR dwell time	—	—	—
	[Pr.50] Setting for the movement amount after near-point dog ON	◎	—	◎
	[Pr.51] OPR acceleration time selection	◎	—	◎*2
	[Pr.52] OPR deceleration time selection	◎	—	◎
	[Pr.53] OP shift amount	◎*2	—	◎*2
	[Pr.54] OPR torque limit value	—	—	—
	[Pr.55] Deviation counter clear signal output time	—	◎*3	◎*3
	[Pr.56] Speed specification during OP shift	◎*2	—	◎*2
	[Pr.57] Dwell time during OPR retry	◎*1	—	◎
	[Pr.58] Setting of operation during uncompleted OPR	◎	◎	◎

*1 Set these items when the OPR retry function is used.

*2 Set these items when the OP shift function is used.

*3 Set the output time of Deviation counter clear signal.

Checking OPR parameters

OPR parameters are checked at the following timings.

- When [Cd.190] PLC READY signal output from the CPU module to the positioning module changes from off to on
- When the [Start] button is clicked for the "Positioning Test" in GX Works3

Setting items for positioning data

Positioning data must be set to perform Major positioning control. The following table lists the setting items for Positioning data. 1 to 600 items of Positioning data can be set for each axis.

◎: Always set

○: Set as required

×: Setting not possible (If these items are set, Continuous path control not possible (Error code: 1A1EH or 1A1FH) occurs at the start.)

—: Setting not required (The set value is ignored. Set the value within the setting range, such as the initial value.)

Setting items for positioning data			Position control		
			1-axis linear control 2-axis linear interpolation control	1-axis fixed-feed control 2-axis fixed-feed control	2-axis circular interpolation control
[Da.1]	Operation pattern	Independent positioning control (positioning complete)	◎	◎	◎
		Continuous positioning control	◎	◎	◎
		Continuous path control	◎	×	◎
[Da.2]	Control method	Line 1 Line 2 *1	Fixed-feed 1 Fixed-feed 2	Circular sub Circular right Circular left *1	
[Da.3]	Acceleration time No.	◎	◎	◎	
[Da.4]	Deceleration time No.	◎	◎	◎	
[Da.5]	Axis to be interpolated	◎: 2-axis interpolation control —: 1-axis control			
[Da.6]	Positioning address/movement amount	◎	◎	◎	
[Da.7]	Arc address	—	—	◎	
[Da.8]	Command speed	◎	◎	◎	
[Da.9]	Dwell time	○	○	○	
[Da.10]	M code	○	○	○	
[Da.27]	M code ON signal output timing	○	○	○	
[Da.28]	ABS direction in degrees	○	○	○	
[Da.29]	Interpolation speed specification method	—: 1-axis control ○: 2-axis interpolation control			

Setting items for positioning data			Speed control		Speed-position switching control	Position-speed switching control
			1-axis speed control 2-axis speed control			
[Da.1]	Operation pattern	Independent positioning control (positioning complete)	◎	◎	◎	◎
		Continuous positioning control	×	◎	×	×
		Continuous path control	×	×	×	×
[Da.2]	Control method	Forward run speed 1 Reverse run speed 1 Forward run speed 2 Reverse run speed 2	Forward run speed-position Reverse run speed-position *1	Forward run position-speed Reverse run position-speed		
[Da.3]	Acceleration time No.	◎	◎	◎		

Setting items for positioning data		Speed control		Speed-position switching control	Position-speed switching control
		1-axis speed control	2-axis speed control		
[Da.4]	Deceleration time No.	◎		◎	◎
[Da.5]	Axis to be interpolated	◎: 2-axis interpolation control —: 1-axis control		—	—
[Da.6]	Positioning address/movement amount	—		◎	◎
[Da.7]	Arc address	—		—	—
[Da.8]	Command speed	◎		◎	◎
[Da.9]	Dwell time	—		○	○
[Da.10]	M code	○		○	○
[Da.27]	M code ON signal output timing	○		○	○
[Da.28]	ABS direction in degrees	○		○	○
[Da.29]	Interpolation speed specification method	—: 1-axis control ○: 2-axis interpolation control			—

*1 Control methods include the absolute (ABS) method and the incremental (INC) method.

Setting items for positioning data			Other controls				
			NOP instruction	Current value change	JUMP instruction	LOOP instruction	LEND instruction
[Da.1]	Operation pattern	Independent positioning control (positioning complete)	—	◎	—	—	—
		Continuous positioning control	—	◎	—	—	—
		Continuous path control	—	×	—	—	—
[Da.2]	Control method		NOP instruction	Current value change	JUMP instruction	LOOP instruction	LEND instruction
[Da.3]	Acceleration time No.		—	—	—	—	—
[Da.4]	Deceleration time No.		—	—	—	—	—
[Da.5]	Axis to be interpolated		—	—	—	—	—
[Da.6]	Positioning address/movement amount		—	◎ Address after change	—	—	—
[Da.7]	Arc address		—	—	—	—	—
[Da.8]	Command speed		—	—	—	—	—
[Da.9]	Dwell time		—	—	◎ JUMP destination positioning data No.	—	—
[Da.10]	M code		—	○	○ Condition data No. at JUMP	◎ Number of repetitions	—
[Da.27]	M code ON signal output timing		—	○	—	—	—
[Da.28]	ABS direction in degrees		—	—	—	—	—
[Da.29]	Interpolation speed specification method		—	—	—	—	—

Checking positioning data

The positioning data is checked at the positioning start.

Block start data setting items

Values indicating the current values

Block start data must be set to perform Advanced positioning control. The following table lists the setting items for Block start data.

Up to 50 points of Block start data can be set for each axis.

○: Set as required

—: Setting not required (Because this item is an irrelevant item, the set value is ignored. Set the value within the setting range, such as the initial value.)

Block start data setting items		Block start (normal start)	Condition start	Wait start
[Da.11]	Shape (end/continue)	○	○	○
[Da.12]	Start data No.	○	○	○
[Da.13]	Special start instruction	—	○	○
[Da.14]	Parameter	—	○	○

Block start data setting items		Simultaneous start	Repeated start (FOR loop)	Repeated start (FOR condition)
[Da.11]	Shape (end/continue)	○	○	○
[Da.12]	Start data No.	○	○	○
[Da.13]	Special start instruction	○	○	○
[Da.14]	Parameter	○	○	○

Checking block start data

Block start data is checked when the block start data starts.

Setting items for condition data

Condition data must be set as required to perform Advanced positioning control or use the JUMP instruction in Major positioning control. The following table lists the setting items for Condition data.

Up to 10 items of Condition data can be set for each axis.

○: Set as required

△: Setting restricted

—: Setting not required (Because this item is an irrelevant item, the set value is ignored. Set the value within the setting range, such as the initial value.)

Condition data		Major positioning control		Advanced positioning control	
		Other than JUMP instruction	JUMP instruction	Block start (normal start)	Condition start
[Da.15]	Condition target	—	○	—	○
[Da.16]	Condition Operator	—	○	—	○
[Da.17]	Address	—	△	—	△
[Da.18]	Parameter 1	—	○	—	○
[Da.19]	Parameter 2	—	△	—	△

Condition data		Advanced positioning control			
		Wait start	Simultaneous start	Repeated start (FOR loop)	Repeated start (FOR condition)
[Da.15]	Condition target	○	○	—	○
[Da.16]	Condition Operator	○	○	—	○
[Da.17]	Address	△	—	—	△
[Da.18]	Parameter 1	○	△	—	○
[Da.19]	Parameter 2	△	△	—	△

Checking condition data

Condition data is checked at the following timings.

- When Block start data starts
- When JUMP instruction starts

17.2 List of Buffer Memory Addresses

This section lists the buffer memory addresses of the positioning module. For details on the buffer memory addresses, refer to the following.

Page 354 DATA USED FOR POSITIONING CONTROL



Do not write data to system areas and monitor data ([Md.]) in the buffer memory. Writing data to these areas may cause malfunction.

Basic setting

Basic parameter 1

Buffer memory address Decimal (Hexadecimal)		Name	Default value	Auto refresh
Axis 1	Axis 2			
0 (0H)	150 (96H)	[Pr.1] Unit setting	3	×
1 (1H)	151 (97H)	[Pr.2] No. of pulses per rotation (16 bits)	20000	×
2 (2H)	152 (98H)	[Pr.3] Movement amount per rotation (16 bits)	20000	×
3 (3H)	153 (99H)	[Pr.4] Unit magnification	1	×
4 (4H)	154 (9AH)	[Pr.5] Pulse output mode	1	×
5 (5H)	155 (9BH)	[Pr.6] Rotation direction setting	0	×
6 (6H)	156 (9CH)	[Pr.7] Bias speed at start	0	×
7 (7H)	157 (9DH)			
8 (8H)	158 (9EH)	System area	—	—
9 (9H)	159 (9FH)			
100 (64H)	250 (FAH)	[Pr.62] Electronic gear selection	0	×
101 (65H)	251 (FBH)	System area	—	—
102 (66H)	252 (FCH)	[Pr.2] No. of pulses per rotation (32 bits)	20000	×
103 (67H)	253 (FDH)			
104 (68H)	254 (FEH)	[Pr.3] Movement amount per rotation (32 bits)	20000	×
105 (69H)	255 (FFH)			
106 (6AH) to 133 (85H)	256 (F1H) to 283 (11BH)	System area	—	—

■Basic parameter 2

Buffer memory address Decimal (Hexadecimal)		Name	Default value	Auto refresh
Axis 1	Axis 2			
10 (AH)	160 (A0H)	[Pr.8] Speed limit value	200000	×
11 (BH)	161 (A1H)			
12 (CH)	162 (A2H)	[Pr.9] Acceleration time 0	1000	×
13 (DH)	163 (A3H)			
14 (EH)	164 (A4H)	[Pr.10] Deceleration time 0	1000	×
15 (FH)	165 (A5H)			
16 (10H)	166 (A6H)	System area	—	—

■Detailed parameter 1

Buffer memory address Decimal (Hexadecimal)		Name	Default value	Auto refresh
Axis 1	Axis 2			
17 (11H)	167 (A7H)	[Pr.11] Backlash compensation amount	0	×
18 (12H)	168 (A8H)	[Pr.12] Software stroke limit upper limit value	2147483647	×
19 (13H)	169 (A9H)			
20 (14H)	170 (AAH)	[Pr.13] Software stroke limit lower limit value	-2147483648	×
21 (15H)	171 (ABH)			
22 (16H)	172 (ACH)	[Pr.14] Software stroke limit selection	0	×
23 (17H)	173 (ADH)	[Pr.15] Software stroke limit valid/invalid setting	0	×
24 (18H)	174 (AEH)	[Pr.16] Command in-position width	100	×
25 (19H)	175 (AFH)			
26 (1AH)	176 (B0H)	[Pr.17] Torque limit setting value	300	×
27 (1BH)	177 (B1H)	[Pr.18] M code ON signal output timing	0	×
28 (1CH)	178 (B2H)	[Pr.19] Speed switching mode	0	×
29 (1DH)	179 (B3H)	[Pr.20] Interpolation speed specification method	0	×
30 (1EH)	180 (B4H)	[Pr.21] Current feed value during speed control	0	×
31 (1FH)	181 (B5H)	[Pr.22] Input signal logic selection	0	×
32 (20H)	182 (B6H)	[Pr.23] Output signal logic selection	0	×
33 (21H)	—	[Pr.24] Manual pulse generator input selection	0	×
34 (22H)	184 (B8H)	[Pr.150] Speed-position function selection	0	×
35 (23H)	185 (B9H)	System area	—	—

■Detailed parameter 2

Buffer memory address Decimal (Hexadecimal)		Name	Default value	Auto refresh
Axis 1	Axis 2			
36 (24H)	186 (BAH)	[Pr.25] Acceleration time 1	1000	×
37 (25H)	187 (BBH)			
38 (26H)	188 (BCH)	[Pr.26] Acceleration time 2	1000	×
39 (27H)	189 (BDH)			
40 (28H)	190 (BEH)	[Pr.27] Acceleration time 3	1000	×
41 (29H)	191 (BFH)			
42 (2AH)	192 (COH)	[Pr.28] Deceleration time 1	1000	×
43 (2BH)	193 (C1H)			
44 (2CH)	194 (C2H)	[Pr.29] Deceleration time 2	1000	×
45 (2DH)	195 (C3H)			
46 (2EH)	196 (C4H)	[Pr.30] Deceleration time 3	1000	×
47 (2FH)	197 (C5H)			
48 (30H)	198 (C6H)	[Pr.31] JOG speed limit value	20000	×
49 (31H)	199 (C7H)			
50 (32H)	200 (C8H)	[Pr.32] JOG operation acceleration time selection	0	×
51 (33H)	201 (C9H)	[Pr.33] JOG operation deceleration time selection	0	×
52 (34H)	202 (CAH)	[Pr.34] Acceleration/deceleration processing selection	0	×
53 (35H)	203 (CBH)	[Pr.35] S-curve ratio	100	×
54 (36H)	204 (CCH)	[Pr.36] Sudden stop deceleration time	1000	×
55 (37H)	205 (CDH)			
56 (38H)	206 (CEH)	[Pr.37] Stop group 1 sudden stop selection	0	×
57 (39H)	207 (CFH)	[Pr.38] Stop group 2 sudden stop selection	0	×
58 (3AH)	208 (D0H)	[Pr.39] Stop group 3 sudden stop selection	0	×
59 (3BH)	209 (D1H)	[Pr.40] Positioning complete signal output time	300	×
60 (3CH)	210 (D2H)	[Pr.41] Allowable circular interpolation error width	100	×
61 (3DH)	211 (D3H)			
62 (3EH)	212 (D4H)	[Pr.42] External command function selection	0	×

Buffer memory address Decimal (Hexadecimal)		Name	Default value	Auto refresh
Axis 1	Axis 2			
63 (3FH) to 69 (45H)	213 (D5H) to 219 (DBH)	System area	—	—
120 (78H)	270 (10EH)			
134 (86H)	284 (11CH)	[Pr.82] Start adjustment time	0	×
135 (87H)	285 (11DH)			

■OPR basic parameter

Buffer memory address Decimal (Hexadecimal)		Name	Default value	Auto refresh
Axis 1	Axis 2			
70 (46H)	220 (DCH)	[Pr.43] OPR method	0	×
71 (47H)	221 (DDH)	[Pr.44] OPR direction	0	×
72 (48H)	222 (DEH)	[Pr.45] OP address	0	×
73 (49H)	223 (DFH)			
74 (4AH)	224 (E0H)	[Pr.46] OPR speed	1	×
75 (4BH)	225 (E1H)			
76 (4CH)	226 (E2H)	[Pr.47] Creep speed	1	×
77 (4DH)	227 (E3H)			
78 (4EH)	228 (E4H)	[Pr.48] OPR retry	0	×

■OPR detailed parameter

Buffer memory address Decimal (Hexadecimal)		Name	Default value	Auto refresh
Axis 1	Axis 2			
79 (4FH)	229 (E5H)	[Pr.49] OPR dwell time	0	×
80 (50H)	230 (E6H)	[Pr.50] Setting for the movement amount after near-point dog ON	0	×
81 (51H)	231 (E7H)			
82 (52H)	232 (E8H)	[Pr.51] OPR acceleration time selection	0	×
83 (53H)	233 (E9H)	[Pr.52] OPR deceleration time selection	0	×
84 (54H)	234 (EAH)	[Pr.53] OP shift amount	0	×
85 (55H)	235 (EBH)			
86 (56H)	236 (ECH)	[Pr.54] OPR torque limit value	300	×
87 (57H)	237 (EDH)	[Pr.55] Deviation counter clear signal output time	11	×
88 (58H)	238 (EEH)	[Pr.56] Speed specification during OP shift	0	×

Buffer memory address Decimal (Hexadecimal)		Name	Default value	Auto refresh
Axis 1	Axis 2			
89 (59H)	239 (EFH)	[Pr.57] Dwell time during OPR retry	0	×
90 (5AH)	240 (F0H)	[Pr.58] Setting of operation during uncompleted OPR	0	×
91 (5BH) to 99 (63H)	241 (F1H) to 249 (F9H)	System area	—	—

Monitor Data

■Axis monitor data

Buffer memory address Decimal (Hexadecimal)		Name	Default value	Auto refresh
Axis 1	Axis 2			
800 (320H)	900 (384H)	[Md.20] Current feed value	0	○
801 (321H)	901 (385H)			
802 (322H)	902 (386H)	[Md.21] Machine feed value	0	○
803 (323H)	903 (387H)			
804 (324H)	904 (388H)	[Md.22] Feedrate	0	○
805 (325H)	905 (389H)			
806 (326H)	906 (38AH)	[Md.23] Axis error No.	0	○
807 (327H)	907 (38BH)	[Md.24] Axis warning No.	0	○
808 (328H)	908 (38CH)	[Md.25] Valid M code	0	○
809 (329H)	909 (38DH)	[Md.26] Axis operation status	0	○
810 (32AH)	910 (38EH)	[Md.27] Current speed	0	○
811 (32BH)	911 (38FH)			
812 (32CH)	912 (390H)	[Md.28] Axis feedrate	0	○
813 (32DH)	913 (391H)			
814 (32EH)	914 (392H)	[Md.29] Speed-position switching control positioning amount	0	○
815 (32FH)	915 (393H)			
816 (330H)	916 (394H)	[Md.30] External I/O signal	0000H	○
817 (331H)	917 (395H)	[Md.31] Status	0008H	○
818 (332H)	918 (396H)	[Md.32] Target value	0	○
819 (333H)	919 (397H)			

Buffer memory address Decimal (Hexadecimal)		Name	Default value	Auto refresh	
Axis 1	Axis 2				
820 (334H)	920 (398H)	[Md.33] Target speed	0	○	
821 (335H)	921 (399H)				
822 (336H)	922 (39AH)	[Md.63] OPR request flag ON factor	0	○	
823 (337H)	923 (39BH)	[Md.64] Positioning control complete factor	0	○	
824 (338H)	924 (39CH)	[Md.34] Movement amount after near-point dog ON	0	○	
825 (339H)	925 (39DH)				
826 (33AH)	926 (39EH)	[Md.35] Torque limit stored value	0	○	
827 (33BH)	927 (39FH)	[Md.36] Special start data instruction code setting value	0	○	
828 (33CH)	928 (3A0H)	[Md.37] Special start data instruction parameter setting value	0	○	
829 (33DH)	929 (3A1H)	[Md.38] Start positioning data No. setting value	0	○	
830 (33EH)	930 (3A2H)	[Md.39] In speed limit flag	0	○	
831 (33FH)	931 (3A3H)	[Md.40] In speed change processing flag	0	○	
832 (340H)	932 (3A4H)	[Md.41] Special start repetition counter	0	○	
833 (341H)	933 (3A5H)	[Md.42] Control method repetition counter	0000H	○	
834 (342H)	934 (3A6H)	[Md.43] Start data pointer being executed	0	○	
835 (343H)	935 (3A7H)	[Md.44] Positioning data No. being executed	0	○	
836 (344H)	936 (3A8H)	[Md.45] Block No. being executed	0	○	
837 (345H)	937 (3A9H)	[Md.46] Last executed positioning data No.	0	○	
838 (346H)	938 (3AAH)	[Md.47] Positioning data being executed	Positioning identifier	0	○
839 (347H)	939 (3ABH)		M code	0	○
840 (348H)	940 (3ACH)		Dwell time	0	○
841 (349H)	941 (3ADH)		Positioning option	0	○
842 (34AH)	942 (3AEH)		Command speed	0	○
843 (34BH)	943 (3AFH)				
844 (34CH)	944 (3B0H)		Positioning address	0	○
845 (34DH)	945 (3B1H)				
846 (34EH)	946 (3B2H)		Arc address	0	○
847 (34FH)	947 (3B3H)				

Buffer memory address Decimal (Hexadecimal)		Name	Default value	Auto refresh
Axis 1	Axis 2			
848 (350H) to 856 (358H)	948 (3B4H) to 956 (3BCH)	System area	—	—
857 (359H)	957 (3BDH)	[Md.60] Analysis mode	0	○
858 (35AH)	958 (3BEH)	[Md.61] Analysis complete flag	0	○
859 (35BH) to 898 (382H)	959 (3BFH) to 998 (3E6H)	System area	—	—
899 (383H)	999 (3E7H)	[Md.48] Deceleration start flag	0	○

■ System monitor data

Buffer memory address Decimal (Hexadecimal)		Name	Default value	Auto refresh	
Axis 1	Axis 2				
1200(4B0H)		[Md.1] In test mode flag	0	×	
1201(4B1H)		[Md.70] Amplifier-less operation mode status	0	×	
1202(4B2H) to 1205(4B5H)		System area	—	—	
1206(4B6H), 1207(4B7H)		[Md.130] Firmware version	Default value	—	
1208(4B8H) to 1211(4BBH)		System area	—	—	
1212(4BCH)		Start history 0	[Md.3] Start information	0000H	×
1213(4BDH)			[Md.4] Start No.	0000H	×
1214(4BEH)			[Md.5] Start (date/hour)	0000H	×
1215(4BFH)			[Md.6] Start (minute/second)	0000H	×
1216(4C0H)			[Md.7] Error judgment	0000H	×
1440(5A0H)			[Md.50] Start (year/month)	0000H	×
1217(4C1H)			Start history 1	[Md.3] Start information	0000H
1218(4C2H)		[Md.4] Start No.		0000H	×
1219(4C3H)		[Md.5] Start (date/hour)		0000H	×
1220(4C4H)		[Md.6] Start (minute/second)		0000H	×
1221(4C5H)		[Md.7] Error judgment		0000H	×
1441(5A1H)		[Md.50] Start (year/month)		0000H	×
1222(4C6H)		Start history 2		[Md.3] Start information	0000H
1223(4C7H)			[Md.4] Start No.	0000H	×
1224(4C8H)			[Md.5] Start (date/hour)	0000H	×
1225(4C9H)			[Md.6] Start (minute/second)	0000H	×
1226(4CAH)			[Md.7] Error judgment	0000H	×
1442(5A2H)			[Md.50] Start (year/month)	0000H	×
1227(4CBH)			Start history 3	[Md.3] Start information	0000H
1228(4CCH)		[Md.4] Start No.		0000H	×
1229(4CDH)		[Md.5] Start (date/hour)		0000H	×
1230(4CEH)		[Md.6] Start (minute/second)		0000H	×
1231(4CFH)		[Md.7] Error judgment		0000H	×
1443(5A3H)		[Md.50] Start (year/month)		0000H	×

Buffer memory address Decimal (Hexadecimal)		Name	Default value	Auto refresh	
Axis 1	Axis 2				
1232(4D0H)		Start history 4	[Md.3] Start information	0000H	×
1233(4D1H)			[Md.4] Start No.	0000H	×
1234(4D2H)			[Md.5] Start (date/hour)	0000H	×
1235(4D3H)			[Md.6] Start (minute/second)	0000H	×
1236(4D4H)			[Md.7] Error judgment	0000H	×
1444(5A4H)			[Md.50] Start (year/month)	0000H	×
1237(4D5H)		Start history 5	[Md.3] Start information	0000H	×
1238(4D6H)			[Md.4] Start No.	0000H	×
1239(4D7H)			[Md.5] Start (date/hour)	0000H	×
1240(4D8H)			[Md.6] Start (minute/second)	0000H	×
1241(4D9H)			[Md.7] Error judgment	0000H	×
1445(5A5H)			[Md.50] Start (year/month)	0000H	×
1242(4DAH)		Start history 6	[Md.3] Start information	0000H	×
1243(4DBH)			[Md.4] Start No.	0000H	×
1244(4DCH)			[Md.5] Start (date/hour)	0000H	×
1245(4DDH)			[Md.6] Start (minute/second)	0000H	×
1246(4DEH)			[Md.7] Error judgment	0000H	×
1446(5A6H)			[Md.50] Start (year/month)	0000H	×
1247(4DFH)		Start history 7	[Md.3] Start information	0000H	×
1248(4E0H)			[Md.4] Start No.	0000H	×
1249(4E1H)			[Md.5] Start (date/hour)	0000H	×
1250(4E2H)			[Md.6] Start (minute/second)	0000H	×
1251(4E3H)			[Md.7] Error judgment	0000H	×
1447(5A7H)			[Md.50] Start (year/month)	0000H	×
1252(4E4H)		Start history 8	[Md.3] Start information	0000H	×
1253(4E5H)			[Md.4] Start No.	0000H	×
1254(4E6H)			[Md.5] Start (date/hour)	0000H	×
1255(4E7H)			[Md.6] Start (minute/second)	0000H	×
1256(4E8H)			[Md.7] Error judgment	0000H	×
1448(5A8H)			[Md.50] Start (year/month)	0000H	×
1257(4E9H)		Start history 9	[Md.3] Start information	0000H	×
1258(4EAH)			[Md.4] Start No.	0000H	×
1259(4EBH)			[Md.5] Start (date/hour)	0000H	×
1260(4ECH)			[Md.6] Start (minute/second)	0000H	×
1261(4EDH)			[Md.7] Error judgment	0000H	×
1449(5A9H)			[Md.50] Start (year/month)	0000H	×
1262(4EEH)		Start history 10	[Md.3] Start information	0000H	×
1263(4EFH)			[Md.4] Start No.	0000H	×
1264(4F0H)			[Md.5] Start (date/hour)	0000H	×
1265(4F1H)			[Md.6] Start (minute/second)	0000H	×
1266(4F2H)			[Md.7] Error judgment	0000H	×
1450(5AAH)			[Md.50] Start (year/month)	0000H	×
1267(4F3H)		Start history 11	[Md.3] Start information	0000H	×
1268(4F4H)			[Md.4] Start No.	0000H	×
1269(4F5H)			[Md.5] Start (date/hour)	0000H	×
1270(4F6H)			[Md.6] Start (minute/second)	0000H	×
1271(4F7H)			[Md.7] Error judgment	0000H	×
1451(5ABH)			[Md.50] Start (year/month)	0000H	×

Buffer memory address Decimal (Hexadecimal)		Name	Default value	Auto refresh	
Axis 1	Axis 2				
1272(4F8H)		Start history 12	[Md.3] Start information	0000H	×
1273(4F9H)			[Md.4] Start No.	0000H	×
1274(4FAH)			[Md.5] Start (date/hour)	0000H	×
1275(4FBH)			[Md.6] Start (minute/second)	0000H	×
1276(4FCH)			[Md.7] Error judgment	0000H	×
1452(5ACH)			[Md.50] Start (year/month)	0000H	×
1277(4FDH)		Start history 13	[Md.3] Start information	0000H	×
1278(4FEH)			[Md.4] Start No.	0000H	×
1279(4FFH)			[Md.5] Start (date/hour)	0000H	×
1280(500H)			[Md.6] Start (minute/second)	0000H	×
1281(501H)			[Md.7] Error judgment	0000H	×
1453(5ADH)			[Md.50] Start (year/month)	0000H	×
1282(502H)		Start history 14	[Md.3] Start information	0000H	×
1283(503H)			[Md.4] Start No.	0000H	×
1284(504H)			[Md.5] Start (date/hour)	0000H	×
1285(505H)			[Md.6] Start (minute/second)	0000H	×
1286(506H)			[Md.7] Error judgment	0000H	×
1454(5AEH)			[Md.50] Start (year/month)	0000H	×
1287(507H)		Start history 15	[Md.3] Start information	0000H	×
1288(508H)			[Md.4] Start No.	0000H	×
1289(509H)			[Md.5] Start (date/hour)	0000H	×
1290(50AH)			[Md.6] Start (minute/second)	0000H	×
1291(50BH)			[Md.7] Error judgment	0000H	×
1455(5AFH)			[Md.50] Start (year/month)	0000H	×
1292(50CH)		[Md.8] Start history pointer	0	×	
1293(50DH)		Error history 0	[Md.9] Axis in which the error occurred	0	×
1294(50EH)			[Md.10] Error No.	0	×
1295(50FH)			[Md.11] Error occurrence (date/hour)	0000H	×
1296(510H)			[Md.12] Error occurrence (minute/second)	0000H	×
1456(5B0H)			[Md.51] Error occurrence (year/month)	0000H	×
1297(511H)		Error history 1	[Md.9] Axis in which the error occurred	0	×
1298(512H)			[Md.10] Error No.	0	×
1299(513H)			[Md.11] Error occurrence (date/hour)	0000H	×
1300(514H)			[Md.12] Error occurrence (minute/second)	0000H	×
1457(5B1H)			[Md.51] Error occurrence (year/month)	0000H	×
1301(515H)		Error history 2	[Md.9] Axis in which the error occurred	0	×
1302(516H)			[Md.10] Error No.	0	×
1303(517H)			[Md.11] Error occurrence (date/hour)	0000H	×
1304(518H)			[Md.12] Error occurrence (minute/second)	0000H	×
1458(5B2H)			[Md.51] Error occurrence (year/month)	0000H	×
1305(519H)		Error history 3	[Md.9] Axis in which the error occurred	0	×
1306(51AH)			[Md.10] Error No.	0	×
1307(51BH)			[Md.11] Error occurrence (date/hour)	0000H	×
1308(51CH)			[Md.12] Error occurrence (minute/second)	0000H	×
1459(5B3H)			[Md.51] Error occurrence (year/month)	0000H	×
1309(51DH)		Error history 4	[Md.9] Axis in which the error occurred	0	×
1310(51EH)			[Md.10] Error No.	0	×
1311(51FH)			[Md.11] Error occurrence (date/hour)	0000H	×
1312(520H)			[Md.12] Error occurrence (minute/second)	0000H	×
1460(5B4H)			[Md.51] Error occurrence (year/month)	0000H	×

Buffer memory address Decimal (Hexadecimal)		Name	Default value	Auto refresh	
Axis 1	Axis 2				
1313(521H)		Error history 5	[Md.9] Axis in which the error occurred	0	×
1314(522H)			[Md.10] Error No.	0	×
1315(523H)			[Md.11] Error occurrence (date/hour)	0000H	×
1316(524H)			[Md.12] Error occurrence (minute/second)	0000H	×
1461(5B5H)			[Md.51] Error occurrence (year/month)	0000H	×
1317(525H)		Error history 6	[Md.9] Axis in which the error occurred	0	×
1318(526H)			[Md.10] Error No.	0	×
1319(527H)			[Md.11] Error occurrence (date/hour)	0000H	×
1320(528H)			[Md.12] Error occurrence (minute/second)	0000H	×
1462(5B6H)			[Md.51] Error occurrence (year/month)	0000H	×
1321(529H)		Error history 7	[Md.9] Axis in which the error occurred	0	×
1322(52AH)			[Md.10] Error No.	0	×
1323(52BH)			[Md.11] Error occurrence (date/hour)	0000H	×
1324(52CH)			[Md.12] Error occurrence (minute/second)	0000H	×
1463(5B7H)			[Md.51] Error occurrence (year/month)	0000H	×
1325(52DH)		Error history 8	[Md.9] Axis in which the error occurred	0	×
1326(52EH)			[Md.10] Error No.	0	×
1327(52FH)			[Md.11] Error occurrence (date/hour)	0000H	×
1328(530H)			[Md.12] Error occurrence (minute/second)	0000H	×
1464(5B8H)			[Md.51] Error occurrence (year/month)	0000H	×
1329(531H)		Error history 9	[Md.9] Axis in which the error occurred	0	×
1330(532H)			[Md.10] Error No.	0	×
1331(533H)			[Md.11] Error occurrence (date/hour)	0000H	×
1332(534H)			[Md.12] Error occurrence (minute/second)	0000H	×
1465(5B9H)			[Md.51] Error occurrence (year/month)	0000H	×
1333(535H)		Error history 10	[Md.9] Axis in which the error occurred	0	×
1334(536H)			[Md.10] Error No.	0	×
1335(537H)			[Md.11] Error occurrence (date/hour)	0000H	×
1336(538H)			[Md.12] Error occurrence (minute/second)	0000H	×
1466(5BAH)			[Md.51] Error occurrence (year/month)	0000H	×
1337(539H)		Error history 11	[Md.9] Axis in which the error occurred	0	×
1338(53AH)			[Md.10] Error No.	0	×
1339(53BH)			[Md.11] Error occurrence (date/hour)	0000H	×
1340(53CH)			[Md.12] Error occurrence (minute/second)	0000H	×
1467(5BBH)			[Md.51] Error occurrence (year/month)	0000H	×
1341(53DH)		Error history 12	[Md.9] Axis in which the error occurred	0	×
1342(53EH)			[Md.10] Error No.	0	×
1343(53FH)			[Md.11] Error occurrence (date/hour)	0000H	×
1344(540H)			[Md.12] Error occurrence (minute/second)	0000H	×
1468(5BCH)			[Md.51] Error occurrence (year/month)	0000H	×
1345(541H)		Error history 13	[Md.9] Axis in which the error occurred	0	×
1346(542H)			[Md.10] Error No.	0	×
1347(543H)			[Md.11] Error occurrence (date/hour)	0000H	×
1348(544H)			[Md.12] Error occurrence (minute/second)	0000H	×
1469(5BDH)			[Md.51] Error occurrence (year/month)	0000H	×
1349(545H)		Error history 14	[Md.9] Axis in which the error occurred	0	×
1350(546H)			[Md.10] Error No.	0	×
1351(547H)			[Md.11] Error occurrence (date/hour)	0000H	×
1352(548H)			[Md.12] Error occurrence (minute/second)	0000H	×
1470(5BEH)			[Md.51] Error occurrence (year/month)	0000H	×

Buffer memory address Decimal (Hexadecimal)		Name	Default value	Auto refresh	
Axis 1	Axis 2				
1353(549H)		Error history 15	[Md.9] Axis in which the error occurred	0	×
1354(54AH)			[Md.10] Error No.	0	×
1355(54BH)			[Md.11] Error occurrence (date/hour)	0000H	×
1356(54CH)			[Md.12] Error occurrence (minute/second)	0000H	×
1471(5BFH)			[Md.51] Error occurrence (year/month)	0000H	×
1357(54DH)		[Md.13] Error history pointer	0	×	
1358(54EH)		Warning history 0	[Md.14] Axis in which the warning occurred	0	×
1359(54FH)			[Md.15] Warning No.	0	×
1360(550H)			[Md.16] Warning occurrence (date/hour)	0000H	×
1361(551H)			[Md.17] Warning occurrence (minute/second)	0000H	×
1472(5C0H)			[Md.52] Warning occurrence (year/month)	0000H	×
1362(552H)		Warning history 1	[Md.14] Axis in which the warning occurred	0	×
1363(553H)			[Md.15] Warning No.	0	×
1364(554H)			[Md.16] Warning occurrence (date/hour)	0000H	×
1365(555H)			[Md.17] Warning occurrence (minute/second)	0000H	×
1473(5C1H)			[Md.52] Warning occurrence (year/month)	0000H	×
1366(556H)		Warning history 2	[Md.14] Axis in which the warning occurred	0	×
1367(557H)			[Md.15] Warning No.	0	×
1368(558H)			[Md.16] Warning occurrence (date/hour)	0000H	×
1369(559H)			[Md.17] Warning occurrence (minute/second)	0000H	×
1474(5C2H)			[Md.52] Warning occurrence (year/month)	0000H	×
1370(55AH)		Warning history 3	[Md.14] Axis in which the warning occurred	0	×
1371(55BH)			[Md.15] Warning No.	0	×
1372(55CH)			[Md.16] Warning occurrence (date/hour)	0000H	×
1373(55DH)			[Md.17] Warning occurrence (minute/second)	0000H	×
1475(5C3H)			[Md.52] Warning occurrence (year/month)	0000H	×
1374(55EH)		Warning history 4	[Md.14] Axis in which the warning occurred	0	×
1375(55FH)			[Md.15] Warning No.	0	×
1376(560H)			[Md.16] Warning occurrence (date/hour)	0000H	×
1377(561H)			[Md.17] Warning occurrence (minute/second)	0000H	×
1476(5C4H)			[Md.52] Warning occurrence (year/month)	0000H	×
1378(562H)		Warning history 5	[Md.14] Axis in which the warning occurred	0	×
1379(563H)			[Md.15] Warning No.	0	×
1380(564H)			[Md.16] Warning occurrence (date/hour)	0000H	×
1381(565H)			[Md.17] Warning occurrence (minute/second)	0000H	×
1477(5C5H)			[Md.52] Warning occurrence (year/month)	0000H	×
1382(566H)		Warning history 6	[Md.14] Axis in which the warning occurred	0	×
1383(567H)			[Md.15] Warning No.	0	×
1384(568H)			[Md.16] Warning occurrence (date/hour)	0000H	×
1385(569H)			[Md.17] Warning occurrence (minute/second)	0000H	×
1478(5C6H)			[Md.52] Warning occurrence (year/month)	0000H	×
1386(56AH)		Warning history 7	[Md.14] Axis in which the warning occurred	0	×
1387(56BH)			[Md.15] Warning No.	0	×
1388(56CH)			[Md.16] Warning occurrence (date/hour)	0000H	×
1389(56DH)			[Md.17] Warning occurrence (minute/second)	0000H	×
1479(5C7H)			[Md.52] Warning occurrence (year/month)	0000H	×
1390(56EH)		Warning history 8	[Md.14] Axis in which the warning occurred	0	×
1391(56FH)			[Md.15] Warning No.	0	×
1392(570H)			[Md.16] Warning occurrence (date/hour)	0000H	×
1393(571H)			[Md.17] Warning occurrence (minute/second)	0000H	×
1480(5C8H)			[Md.52] Warning occurrence (year/month)	0000H	×

Buffer memory address Decimal (Hexadecimal)		Name	Default value	Auto refresh	
Axis 1	Axis 2				
1394(572H)		Warning history 9	[Md.14] Axis in which the warning occurred	0	×
1395(573H)			[Md.15] Warning No.	0	×
1396(574H)			[Md.16] Warning occurrence (date/hour)	0000H	×
1397(575H)			[Md.17] Warning occurrence (minute/second)	0000H	×
1481(5C9H)			[Md.52] Warning occurrence (year/month)	0000H	×
1398(576H)		Warning history 10	[Md.14] Axis in which the warning occurred	0	×
1399(577H)			[Md.15] Warning No.	0	×
1400(578H)			[Md.16] Warning occurrence (date/hour)	0000H	×
1401(579H)			[Md.17] Warning occurrence (minute/second)	0000H	×
1482(5CAH)			[Md.52] Warning occurrence (year/month)	0000H	×
1402(57AH)		Warning history 11	[Md.14] Axis in which the warning occurred	0	×
1403(57BH)			[Md.15] Warning No.	0	×
1404(57CH)			[Md.16] Warning occurrence (date/hour)	0000H	×
1405(57DH)			[Md.17] Warning occurrence (minute/second)	0000H	×
1483(5CBH)			[Md.52] Warning occurrence (year/month)	0000H	×
1406(57EH)		Warning history 12	[Md.14] Axis in which the warning occurred	0	×
1407(57FH)			[Md.15] Warning No.	0	×
1408(580H)			[Md.16] Warning occurrence (date/hour)	0000H	×
1409(581H)			[Md.17] Warning occurrence (minute/second)	0000H	×
1484(5CCH)			[Md.52] Warning occurrence (year/month)	0000H	×
1410(582H)		Warning history 13	[Md.14] Axis in which the warning occurred	0	×
1411(583H)			[Md.15] Warning No.	0	×
1412(584H)			[Md.16] Warning occurrence (date/hour)	0000H	×
1413(585H)			[Md.17] Warning occurrence (minute/second)	0000H	×
1485(5CDH)			[Md.52] Warning occurrence (year/month)	0000H	×
1414(586H)		Warning history 14	[Md.14] Axis in which the warning occurred	0	×
1415(587H)			[Md.15] Warning No.	0	×
1416(588H)			[Md.16] Warning occurrence (date/hour)	0000H	×
1417(589H)			[Md.17] Warning occurrence (minute/second)	0000H	×
1486(5CEH)			[Md.52] Warning occurrence (year/month)	0000H	×
1418(58AH)		Warning history 15	[Md.14] Axis in which the warning occurred	0	×
1419(58BH)			[Md.15] Warning No.	0	×
1420(58CH)			[Md.16] Warning occurrence (date/hour)	0000H	×
1421(58DH)			[Md.17] Warning occurrence (minute/second)	0000H	×
1487(5CFH)			[Md.52] Warning occurrence (year/month)	0000H	×
1422(58EH)		[Md.18] Warning history pointer	0	×	
1423(58FH)		System area	—	—	
1424(590H)		[Md.19] No. of write accesses to flash ROM	0	×	
1425(591H)					
1426(592H) to 1487(5CFH)		System area	—	—	
1488(5D0H)		[Md.53] Date of write accesses to flash ROM (year/month)	0000H	×	
1489(5D1H)		[Md.54] Date of write accesses to flash ROM (date/hour)	0000H	×	
1490(5D2H)		[Md.55] Date of write accesses to flash ROM (minute/second)	0000H	×	
1491(5D3H)		[Md.56] Date of write accesses to flash ROM (ms)	0000H	×	
31332(7A64H)		[Md.59] Module information	63E2H	×	
31500(7B0CH)		[Md.140] Module status	0000H	×	
31501(7B0DH)		[Md.141] BUSY signal	0000H	×	

Control Data

■Axis control data

Buffer memory address Decimal (Hexadecimal)		Name	Default value	Auto refresh
Axis 1	Axis 2			
1500 (5DCH)	1600 (640H)	[Cd.3] Positioning start No.	0	×
1501 (5DDH)	1601 (641H)	[Cd.4] Positioning starting point No.	0	×
1502 (5DEH)	1602 (642H)	[Cd.5] Axis error reset	0	×
1503 (5DFH)	1603 (643H)	[Cd.6] Restart command	0	×
1504 (5E0H)	1604 (644H)	[Cd.7] M code ON signal OFF request	0	×
1505 (5E1H)	1605 (645H)	[Cd.8] External command valid	0	×
1506 (5E2H)	1606 (646H)	[Cd.9] New current value	0	×
1507 (5E3H)	1607 (647H)			
1508 (5E4H)	1608 (648H)	[Cd.10] New acceleration time value	0	×
1509 (5E5H)	1609 (649H)			
1510 (5E6H)	1610 (64AH)	[Cd.11] New deceleration time value	0	×
1511 (5E7H)	1611 (64BH)			
1512 (5E8H)	1612 (64CH)	[Cd.12] Acceleration/deceleration time change during speed change, enable/disable selection	0	×
1513 (5E9H)	1613 (64DH)	[Cd.13] Positioning operation speed override	100	×
1514 (5EAH)	1614 (64EH)	[Cd.14] New speed value	0	×
1515 (5EBH)	1615 (64FH)			
1516 (5ECH)	1616 (650H)	[Cd.15] Speed change request	0	×
1517 (5EDH)	1617 (651H)	[Cd.16] Inching movement amount	0	×
1518 (5EEH)	1618 (652H)	[Cd.17] JOG speed	0	×
1519 (5EFH)	1619 (653H)			
1520 (5F0H)	1620 (654H)	[Cd.18] Continuous operation interrupt request	0	×
1521 (5F1H)	1621 (655H)	[Cd.19] OPR request flag OFF request	0	×
1522 (5F2H)	1622 (656H)	[Cd.20] Manual pulse generator 1 pulse input magnification	1	×
1523 (5F3H)	1623 (657H)			
1524 (5F4H)	1624 (658H)	[Cd.21] Manual pulse generator enable flag	0	×
1525 (5F5H)	1625 (659H)	[Cd.22] New torque value	0	×

Buffer memory address Decimal (Hexadecimal)		Name	Default value	Auto refresh
Axis 1	Axis 2			
1526 (5F6H)	1626 (65AH)	[Cd.23] Speed-position switching control movement amount change register	0	×
1527 (5F7H)	1627 (65BH)			
1528 (5F8H)	1628 (65CH)	[Cd.24] Speed-position switching enable flag	0	×
1529 (5F9H)	1629 (65DH)	System area	—	—
1530 (5FAH)	1630 (65EH)	[Cd.25] Position-speed switching control speed change register	0	×
1531 (5FBH)	1631 (65FH)			
1532 (5FCH)	1632 (660H)	[Cd.26] Position-speed switching enable flag	0	×
1533 (5FDH)	1633 (661H)	System area	—	—
1534 (5FEH)	1634 (662H)	[Cd.27] Target position change value (new address)	0	×
1535 (5FFH)	1635 (663H)			
1536 (600H)	1636 (664H)	[Cd.28] Target position change value (new speed)	0	×
1537 (601H)	1637 (665H)			
1538 (602H)	1638 (666H)	[Cd.29] Target position change request flag	0	×
1539 (603H)	1639 (667H)	System area	—	—
1540 (604H)	1640 (668H)	[Cd.30] Simultaneous starting axis start data No. (Axis 1 start data No.)	0	×
1541 (605H)	1641 (669H)	[Cd.31] Simultaneous starting axis start data No. (Axis 2 start data No.)	0	×
1542 (606H)	1642 (66AH)	System area	—	—
1543 (607H)	1643 (66BH)			
1544 (608H)	1644 (66CH)	[Cd.34] Step mode	0	×
1545 (609H)	1645 (66DH)	[Cd.35] Step valid flag	0	×
1546 (60AH)	1646 (66EH)	[Cd.36] Step start request	0	×
1547 (60BH)	1647 (66FH)	[Cd.37] Skip command	0	×
1548 (60CH)	1648 (670H)	[Cd.38] Teaching data selection	0	×
1549 (60DH)	1649 (671H)	[Cd.39] Teaching positioning data No.	0	×
1550 (60EH)	1650 (672H)	[Cd.40] ABS direction in degrees	0	×
1551 (60FH) to 1565 (61DH)	1651 (673H) to 1665 (681H)	System area	—	—
1566 (61EH)	1666 (682H)	[Cd.45] Speed↔position switching device selection	0	×
1567 (61FH)	1667 (683H)	[Cd.46] Speed↔position switching command	0	×

Buffer memory address Decimal (Hexadecimal)		Name	Default value	Auto refresh
Axis 1	Axis 2			
1568 (620H) to 1589 (635H)	1668 (684H) to 1689 (699H)	System area	—	—
1590 (636H)	1690 (69AH)	[Cd.43] Analysis mode setting	0	×
1591 (637H) to 1599 (63FH)	1691 (69BH) to 1699 (6A3H)	System area	—	—
30100 (7594H)	30110 (759EH)	[Cd.180] Axis stop signal	0	×
30101 (7595H)	30111 (759FH)	[Cd.181] Forward JOG start signal	0	×
30102 (7596H)	30112 (75A0H)	[Cd.182] Reverse JOG start signal	0	×
30103 (7597H)	30113 (75A1H)	[Cd.183] Execution prohibition flag	0	×
30104 (7598H)	30114 (75A2H)	[Cd.184] Positioning start signal	0	×

■ System control data

Buffer memory address Decimal (Hexadecimal)		Name	Default value	Auto refresh
Axis 1	Axis 2			
1900(76CH)		[Cd.1] Module data backup request	0	×
1901(76DH)		[Cd.2] Module data initialization request	0	×
1902(76EH) to 1904(770H)		System area	—	—
1905(771H)		[Cd.41] Deceleration start flag valid	0	×
1906(772H)		System area	—	—
1907(773H)		[Cd.42] Stop command processing for deceleration stop selection	0	×
1908(774H) to 1925(785H)		System area	—	—
1926(786H)		[Cd.137] Amplifier-less operation mode switching request	0000H	×
1927(787H)		System area	—	—
1928 (788H)	1929 (789H)	[Cd.44] External input signal operation device	0000H	×
1932(78CH)		System area	—	—
1933(78DH)		[Cd.49] All axes error reset	0	×
1934(78EH)		[Cd.43] Output timing selection of near pass control	0	×
1950(79EH)		[Cd.190] PLC READY signal	0	×

Positioning data

■ Positioning data

Buffer memory address Decimal (Hexadecimal)		Name	Default value	Auto refresh		
Axis 1	Axis 2					
2000 (7D0H)	8000 (1F40H)	Positioning data No.1	Positioning identifier • [Da.1] Operation pattern • [Da.2] Control method • [Da.3] Acceleration time No. • [Da.4] Deceleration time No. • [Da.5] Axis to be interpolated	0	×	
2001 (7D1H)	8001 (1F41H)					[Da.10] M code (Condition data No., Number of LOOP to LEND repetitions)
2002 (7D2H)	8002 (1F42H)					[Da.9] Dwell time (JUMP destination positioning data No.)
2003 (7D3H)	8003 (1F43H)					Positioning option • [Da.27] M code ON signal output timing • [Da.28] ABS direction in degrees • [Da.29] Interpolation speed specification method
2004 (7D4H)	8004 (1F44H)					[Da.8] Command speed
2005 (7D5H)	8005 (1F45H)					
2006 (7D6H)	8006 (1F46H)					[Da.6] Positioning address/movement amount
2007 (7D7H)	8007 (1F47H)					
2008 (7D8H)	8008 (1F48H)					[Da.7] Arc address
2009 (7D9H)	8009 (1F49H)					
2010 (7DAH) to 2019 (7E3H)	8010 (1F4AH) to 8019 (1F53H)	Positioning data No.2	—	—		
2020 (7E4H) to 2029 (7EDH)	8020 (1F54H) to 8029 (1F5DH)	Positioning data No.3	—	—		
:						
7990 (1F36H) to 7999 (1F3FH)	13990 (36A6H) to 13999 (36AFH)	Positioning data No.600	—	—		

Block start data

■ Start block 0 (Block No. 7000)

Buffer memory address Decimal (Hexadecimal)		Name		Default value	Auto refresh
Axis 1	Axis 2				
26000 (6590H)	27000 (6978H)	Block start data 1st point	[Da.11] Shape [Da.12] Start data No.	0	×
26050 (65C2H)	27050 (69AAH)		[Da.13] Special start instruction [Da.14] Parameter	0	×
26001 (6591H)	27001 (6979H)	Block start data 2nd point	[Da.11] Shape [Da.12] Start data No.	0	×
26051 (65C3H)	27051 (69ABH)		[Da.13] Special start instruction [Da.14] Parameter	0	×
26002 (6592H)	27002 (697AH)	Block start data 3rd point		0	×
26052 (65C4H)	27052 (69ACH)			0	×
⋮					
26049 (65C1H)	27049 (69A9H)	Block start data 50th point		0	×
26099 (65F3H)	27099 (69DBH)			0	×
26100 (65F4H)	27100 (69DCH)	Condition data No. 1	[Da.15] Condition target [Da.16] Condition operator	0	×
26101 (65F5H)	27101 (69DDH)		System area	—	—
26102 (65F6H)	27102 (69DEH)		[Da.17] Address	0	×
26103 (65F7H)	27103 (69DFH)				
26104 (65F8H)	27104 (69E0H)		[Da.18] Parameter 1	0	×
26105 (65F9H)	27105 (69E1H)				
26106 (65FAH)	27106 (69E2H)		[Da.19] Parameter 2	0	×
26107 (65FBH)	27107 (69E3H)				
26108 (65FCH)	27108 (69E4H)		System area	—	—
26109 (65FDH)	27109 (69E5H)				
26110 (65FEH) to 26119 (6607H)	27110 (69E6H) to 27119 (69EFH)	Condition data No. 2		0	×
26120 (6608H) to 26129 (6611H)	27120 (69F0H) to 27129 (69F9H)	Condition data No. 3		0	×
⋮					
26190 (664EH) to 26199 (6657H)	27190 (6A36H) to 27199 (6A3FH)	Condition data No. 10		0	×

■Start block 1 (Block No. 7001)

Buffer memory address Decimal (Hexadecimal)		Name	Default value	Auto refresh
Axis 1	Axis 2			
26200 (6658H) to 26299 (66BBH)	27200 (6A40H) to 27299 (6AA3H)	Block start data	0	×
26300 (66BCH) to 26399 (671FH)	27300 (6AA4H) to 27399 (6B07H)	Condition data	0	×

■Start block 2 (Block No. 7002)

Buffer memory address Decimal (Hexadecimal)		Name	Default value	Auto refresh
Axis 1	Axis 2			
26400 (6720H) to 26499 (6783H)	27400 (6B08H) to 27499 (6B6BH)	Block start data	0	×
26500 (6784H) to 26599 (67E7H)	27500 (6B6CH) to 27599 (6BCFH)	Condition data	0	×

■Start block 3 (Block No. 7003)

Buffer memory address Decimal (Hexadecimal)		Name	Default value	Auto refresh
Axis 1	Axis 2			
26600 (67E8H) to 26699 (684BH)	27600 (6BD0H) to 27699 (6C33H)	Block start data	0	×
26700 (684CH) to 26799 (68AFH)	27700 (6C34H) to 27799 (6C97H)	Condition data	0	×

■Start block 4 (Block No. 7004)

Buffer memory address Decimal (Hexadecimal)		Name	Default value	Auto refresh
Axis 1	Axis 2			
26800 (68B0H) to 26899 (6913H)	27800 (6C98H) to 27899 (6CFBH)	Block start data	0	×
26900 (6914H) to 26999 (6977H)	27900 (6CFCH) to 27999 (6D5FH)	Condition data	0	×

■PLC CPU memo area

Buffer memory address Decimal (Hexadecimal)		Name	Default value	Auto refresh
Axis 1	Axis 2			
30000(7530H) to 30099(7593H)		Target data for condition judgment of the condition data	0	×

Interrupt setting

■Interrupt setting data

Buffer memory address Decimal (Hexadecimal)		Name	Default value	Auto refresh
Common for axes 1 and 2				
55000(D6D8H)	Interrupt setting No.1	[Md.65] Interrupt factor detection flag	0	×
55064(D718H)		[Cd.50] Interrupt factor mask	0	×
55128(D758H)		[Cd.51] Interrupt factor reset request	0	×
55192(D798H)		[Pr.900] Interrupt factor setting	0	×
55256(D7D8H)		[Pr.901] Axis No. for interrupt factor	0	×
55001(D6D9H)	Interrupt setting No.2	[Md.65] Interrupt factor detection flag	0	×
55065(D719H)		[Cd.50] Interrupt factor mask	0	×
55129(D759H)		[Cd.51] Interrupt factor reset request	0	×
55193(D799H)		[Pr.900] Interrupt factor setting	0	×
55257(D7D9H)		[Pr.901] Axis No. for interrupt factor	0	×
55002(D6DAH)	Interrupt setting No.3	[Md.65] Interrupt factor detection flag	0	×
55066(D71AH)		[Cd.50] Interrupt factor mask	0	×
55130(D75AH)		[Cd.51] Interrupt factor reset request	0	×
55194(D79AH)		[Pr.900] Interrupt factor setting	0	×
55258(D7DAH)		[Pr.901] Axis No. for interrupt factor	0	×
55003(D6DBH)	Interrupt setting No.4	[Md.65] Interrupt factor detection flag	0	×
55067(D71BH)		[Cd.50] Interrupt factor mask	0	×
55131(D75BH)		[Cd.51] Interrupt factor reset request	0	×
55195(D79BH)		[Pr.900] Interrupt factor setting	0	×
55259(D7DBH)		[Pr.901] Axis No. for interrupt factor	0	×
55004(D6DCH)	Interrupt setting No.5	[Md.65] Interrupt factor detection flag	0	×
55068(D71CH)		[Cd.50] Interrupt factor mask	0	×
55132(D75CH)		[Cd.51] Interrupt factor reset request	0	×
55196(D79CH)		[Pr.900] Interrupt factor setting	0	×
55260(D7DCH)		[Pr.901] Axis No. for interrupt factor	0	×
55005(D6DDH)	Interrupt setting No.6	[Md.65] Interrupt factor detection flag	0	×
55069(D71DH)		[Cd.50] Interrupt factor mask	0	×
55133(D75DH)		[Cd.51] Interrupt factor reset request	0	×
55197(D79DH)		[Pr.900] Interrupt factor setting	0	×
55261(D7DDH)		[Pr.901] Axis No. for interrupt factor	0	×
55006(D6DEH)	Interrupt setting No.7	[Md.65] Interrupt factor detection flag	0	×
55070(D71EH)		[Cd.50] Interrupt factor mask	0	×
55134(D75EH)		[Cd.51] Interrupt factor reset request	0	×
55198(D79EH)		[Pr.900] Interrupt factor setting	0	×
55262(D7DEH)		[Pr.901] Axis No. for interrupt factor	0	×
55007(D6DFH)	Interrupt setting No.8	[Md.65] Interrupt factor detection flag	0	×
55071(D71FH)		[Cd.50] Interrupt factor mask	0	×
55135(D75FH)		[Cd.51] Interrupt factor reset request	0	×
55199(D79FH)		[Pr.900] Interrupt factor setting	0	×
55263(D7DFH)		[Pr.901] Axis No. for interrupt factor	0	×

Buffer memory address Decimal (Hexadecimal)	Name		Default value	Auto refresh
Common for axes 1 and 2				
55008(D6E0H)	Interrupt setting No.9	[Md.65] Interrupt factor detection flag	0	×
55072(D720H)		[Cd.50] Interrupt factor mask	0	×
55136(D760H)		[Cd.51] Interrupt factor reset request	0	×
55200(D7A0H)		[Pr.900] Interrupt factor setting	0	×
55264(D7E0H)		[Pr.901] Axis No. for interrupt factor	0	×
55009(D6E1H)	Interrupt setting No.10	[Md.65] Interrupt factor detection flag	0	×
55073(D721H)		[Cd.50] Interrupt factor mask	0	×
55137(D761H)		[Cd.51] Interrupt factor reset request	0	×
55201(D7A1H)		[Pr.900] Interrupt factor setting	0	×
55265(D7E1H)		[Pr.901] Axis No. for interrupt factor	0	×
55010(D6E2H)	Interrupt setting No.11	[Md.65] Interrupt factor detection flag	0	×
55074(D722H)		[Cd.50] Interrupt factor mask	0	×
55138(D762H)		[Cd.51] Interrupt factor reset request	0	×
55202(D7A2H)		[Pr.900] Interrupt factor setting	0	×
55266(D7E2H)		[Pr.901] Axis No. for interrupt factor	0	×
55011(D6E3H)	Interrupt setting No.12	[Md.65] Interrupt factor detection flag	0	×
55075(D723H)		[Cd.50] Interrupt factor mask	0	×
55139(D763H)		[Cd.51] Interrupt factor reset request	0	×
55203(D7A3H)		[Pr.900] Interrupt factor setting	0	×
55267(D7E3H)		[Pr.901] Axis No. for interrupt factor	0	×
55012(D6E4H)	Interrupt setting No.13	[Md.65] Interrupt factor detection flag	0	×
55076(D724H)		[Cd.50] Interrupt factor mask	0	×
55140(D764H)		[Cd.51] Interrupt factor reset request	0	×
55204(D7A4H)		[Pr.900] Interrupt factor setting	0	×
55268(D7E4H)		[Pr.901] Axis No. for interrupt factor	0	×
55013(D6E5H)	Interrupt setting No.14	[Md.65] Interrupt factor detection flag	0	×
55077(D725H)		[Cd.50] Interrupt factor mask	0	×
55141(D765H)		[Cd.51] Interrupt factor reset request	0	×
55205(D7A5H)		[Pr.900] Interrupt factor setting	0	×
55269(D7E5H)		[Pr.901] Axis No. for interrupt factor	0	×
55014(D6E6H)	Interrupt setting No.15	[Md.65] Interrupt factor detection flag	0	×
55078(D726H)		[Cd.50] Interrupt factor mask	0	×
55142(D766H)		[Cd.51] Interrupt factor reset request	0	×
55206(D7A6H)		[Pr.900] Interrupt factor setting	0	×
55270(D7E6H)		[Pr.901] Axis No. for interrupt factor	0	×
55015(D6E7H)	Interrupt setting No.16	[Md.65] Interrupt factor detection flag	0	×
55079(D727H)		[Cd.50] Interrupt factor mask	0	×
55143(D767H)		[Cd.51] Interrupt factor reset request	0	×
55207(D7A7H)		[Pr.900] Interrupt factor setting	0	×
55271(D7E7H)		[Pr.901] Axis No. for interrupt factor	0	×

17.3 Basic Setting

Basic parameter 1

This section describes the details on the basic parameter 1.

[Pr.1] Unit setting

Set the command unit used for the positioning control. Select a unit from the following depending on the control target: mm, inch, degree, or pulse. Different units can be set for axis 1 and axis 2.

Unit setting	Setting value
mm	0
inch	1
degree	2
pulse	3

When the unit setting is changed, the values of other parameters and positioning data will not be changed automatically. After changing the unit, check if the parameter and data values are within the setting range. Set 2: degree to perform the speed-position switching control (ABS mode).

Application examples of each unit

The units (mm, inch, degree, and pulse) are applicable to the following systems:

- mm, inch: XY table, conveyor (Select inch when the machine uses inches as the unit.)
- degree: Rotating body (360 degrees/rotation)
- pulse: XY table, conveyor

Buffer memory address

The following table shows the buffer memory address of this area.

Buffer memory name	Axis 1	Axis 2
[Pr.1] Unit setting	0	150

Default value

The default value is 3: pulse for all the axes.

[Pr.2] No. of pulses per rotation (16 bits) (Ap)

Set the number of pulses required for a rotation of the motor shaft with 16 bits. When [Pr.62] Electronic gear selection is set to 0: 16 bits, this area is valid.

If a Mitsubishi servo amplifier is used, set the value given as Resolution per rotation of the servomotor in the speed-position detector specifications. (When Resolution per rotation of the servomotor of the Mitsubishi servo amplifier exceeds 65535 pulses, configure the setting referring to the Servo Amplifier Instruction Manual.)

- Number of pulses per rotation (Ap) = Resolution per rotation of the servomotor

■ Buffer memory address

The following table shows the buffer memory address of this area.

Buffer memory name	Axis 1	Axis 2
[Pr.2] No. of pulses per rotation (16 bits) (Ap)	1	151

■ Setting range

The setting range is 1 to 65535.

■ Default value

The default value is 20000 for all the axes.

■ Movement amount per pulse

In the positioning module, the parameters [Pr.2] to [Pr.4] define the movement amount per pulse when a pulse train is output. (The following explains how to set the individual parameters when "0: mm" is selected for [Pr.1] Unit setting.)

The movement amount per pulse is given by the following calculation formula:

$$\text{Movement per pulse (A)} = \frac{Al \times Am}{Ap}$$

Item	Symbol
[Pr.2] No. of pulses per rotation	Ap
[Pr.3] Movement amount per rotation	Al
[Pr.4] Unit magnification	Am
Movement amount per pulse	A

Due to the mechanical tolerance, the actual movement amount may differ slightly from the specified movement amount. The error can be compensated by adjusting the value set in Movement amount per pulse. ( Page 386 Movement amount per pulse)

Restriction

If the movement amount per pulse is less than 1, command frequency variations occur. Smaller values will increase variations and may cause machine vibration. If the movement amount per pulse becomes less than 1, also use the electronic gear function of the drive unit and configure the setting so that the movement amount per pulse is 1/500 or greater.

[Pr.3] Movement amount per rotation (16 bits) (AI)

Set the distance of machine movement (movement amount) per rotation of the motor shaft with 16 bits. When [Pr.62] Electronic gear selection is set to 0: 16 bits, this area is valid. When the movement amount per rotation of the motor shaft exceeds the setting range of this area in the system used, adjust the setting value with the following method.

- Use [Pr.4] Unit magnification.
- Use [Pr.3] Movement amount per rotation (32 bits).

■Buffer memory address

The following table shows the buffer memory address of this area.

Buffer memory name	Axis 1	Axis 2
[Pr.3] Movement amount per rotation (16 bits) (AI)	2	152

■Setting range

The setting range depends on the setting of [Pr.1] Unit setting.

Setting of [Pr.1] Unit setting	Setting value via GX Works3	Setting value with programs ^{*1}
0: mm	0.1 to 6553.5 (μm)	1 to 65535 ($\times 10^{-1}$ μm)
1: inch	0.00001 to 0.65535 (inch)	1 to 65535 ($\times 10^{-5}$ inch)
2: degree	0.00001 to 0.65535 (degree)	1 to 65535 ($\times 10^{-5}$ degree)
3: pulse	1 to 65535 (pulse)	1 to 65535 (pulse)

*1 When this buffer memory area is set with programs, a calculation is performed in the positioning module to convert a setting value to the value in each unit. For setting this buffer memory area, take the value after the unit conversion into consideration.

■Default value

The default value is 20000 for all the axes.

[Pr.4] Unit magnification

When the movement amount per rotation of the motor shaft exceeds the setting range of [Pr.3] Movement amount per rotation (16 bits), adjust the setting range (10 to 1000 times) with this area. When [Pr.62] Electronic gear selection is set to 0: 16 bits, this area is valid. When [Pr.62] Electronic gear selection is set to 1: 32 bits, the unit magnification is fixed to 1:1 times.

Unit magnification	Setting value
1 time	1
10 times	10
100 times	100
1000 times	1000

■Buffer memory address

The following table shows the buffer memory address of this area.

Buffer memory name	Axis 1	Axis 2
[Pr.4] Unit magnification	3	153

■Default value

The default value is 1:1 times for all the axes.

[Pr.5] Pulse output mode

Set the pulse output mode to match the servo amplifier used.

Pulse output mode	Setting value
PULSE/SIGN mode	0
CW/CCW mode	1
A phase/B phase mode (multiple of 4)	2
A phase/B phase mode (multiple of 1)	3

Restriction

The only valid value of [Pr.5] Pulse output mode is the value at the moment when [Cd.190] PLC READY signal is turned off and on for the first time after the power is switched on or the CPU module is reset. Once [Cd.190] PLC READY signal is turned on, the value will not be reset even if another value is set to the parameter and [Cd.190] PLC READY signal is turned off and on.

Use [Pr.23] Output signal logic selection to choose between the positive logic (pulse rising edge detection) and negative logic (pulse falling edge detection). For the output specifications of each pulse output mode, refer to the following.

☞ Page 21 External Device Output Interface Specifications

The following shows examples of the pulse output modes for positive and negative logic.

■PULSE/SIGN mode

Positive logic	Negative logic
<p>Forward run and reverse run are controlled with the on/off of the direction sign (SIGN). The motor will forward run when the direction sign is HIGH. The motor will reverse run when the direction sign is LOW.</p>	<p>Forward run and reverse run are controlled with the on/off of the direction sign (SIGN). The motor will forward run when the direction sign is LOW. The motor will reverse run when the direction sign is HIGH.</p>

■CW/CCW mode

During forward run, the forward run feed pulse (PULSE F) is output.

During reverse run, the reverse run feed pulse (PULSE R) is output.

Positive logic	Negative logic

■A phase/B phase mode

Forward run and reverse run are controlled with the phase difference of the A phase ($A\phi$) and B phase ($B\phi$). When the B phase is 90° behind the A phase, the motor will forward run. When the B phase is 90° ahead of the A phase, the motor will reverse run.

- For multiple of 1 setting

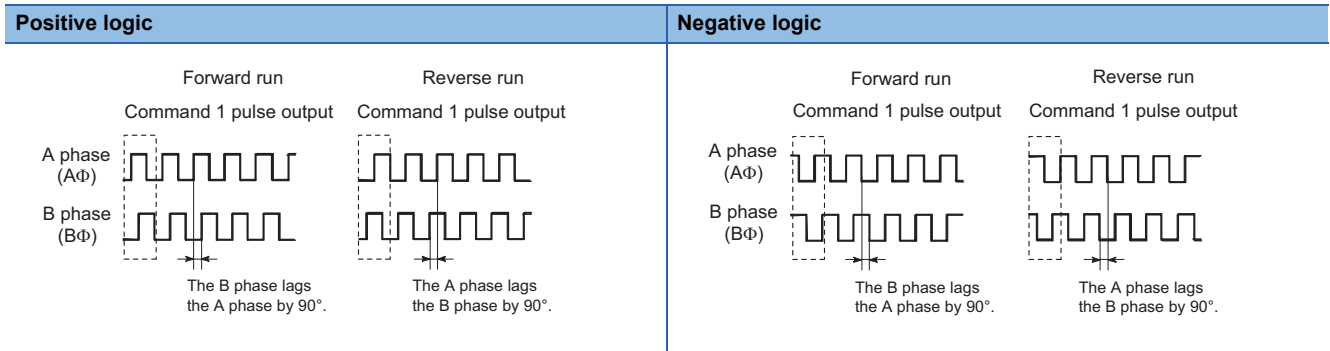

Example) When the command 1 pulse output is set to 1pulse/s, the pulse rises and falls four times per second.

- For multiple of 4 setting

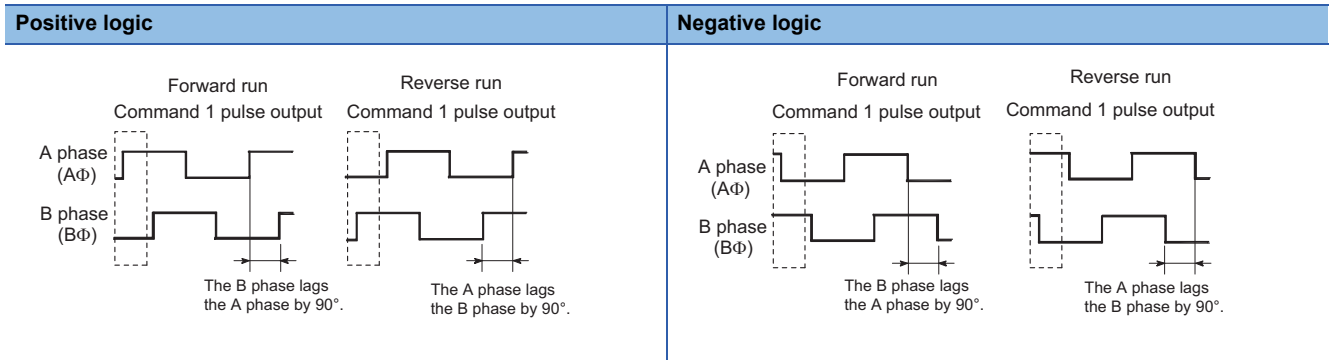

Example) When the command 1 pulse output is set to 1 pulse/s, the pulse rises and falls one time per second.

■Buffer memory address

The following table shows the buffer memory address of this area.

Buffer memory name	Axis 1	Axis 2
[Pr.5] Pulse output mode	4	154

■Default value

The default value is 1: CW/CCW mode for all the axes.

[Pr.6] Rotation direction setting

Set the relation of the positioning direction (increment direction or decrement direction of [Md.20] Current feed value) and the pulse output. For the relation of "Forward run pulse output, Reverse run pulse output" and "CW/A phase/PULSE signal, CCW/B phase/SIGN signal", refer to the following.

☞ Page 388 [Pr.5] Pulse output mode

Rotation direction setting	Setting value
Current value increment with forward run pulse output	0
Current value increment with reverse run pulse output	1

Ex.

The following figure shows the pulse outputs of when [Pr.5] Pulse output mode is set to the CW/CCW mode and the positioning of current feed value increment and of current feed value decrement is executed.

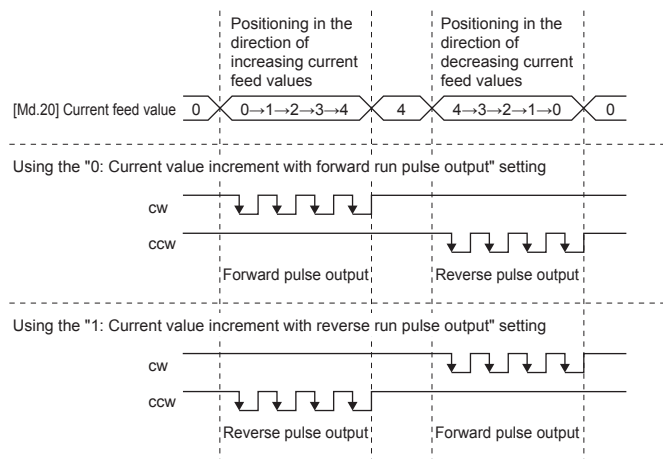

Point

When this area is changed from 0 to 1, check if the upper limit switch and lower limit switch operate properly with JOG operation. If any malfunction is identified, check and correct the wiring. If any malfunction is identified, check and correct the wiring.

■ Buffer memory address

The following table shows the buffer memory address of this area.

Buffer memory name	Axis 1	Axis 2
[Pr.6] Rotation direction setting	5	155

■ Default value

The default value is 0: Current value increment with forward run pulse output for all the axes.

[Pr.7] Bias speed at start

Set Minimum speed at start for Bias speed at start. Set Bias speed at start to allow the motor to start smoothly especially when a stepping motor is used. (A stepping motor does not start smoothly if a low rotation speed is instructed at the start.)

■Bias speed at start is "0"

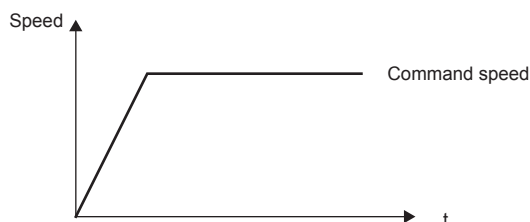

■Bias speed at start is "Other than 0"

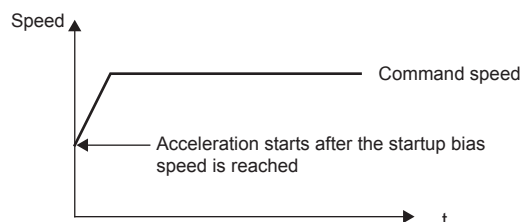

The specified Bias speed at start will be valid during the following operations:

- Positioning operation
- OPR
- JOG operation

Set a value equal to or less than the value set in [Pr.8] Speed limit value.

■Buffer memory address

The following table shows the buffer memory address of this area.

Buffer memory name	Axis 1	Axis 2
[Pr.7] Bias speed at start	6	156
	7	157

■Setting range

The setting range depends on the setting of [Pr.1] Unit setting.

Setting of [Pr.1] Unit setting	Setting value via GX Works3	Setting value with programs ^{*1}
0: mm	0 to 20000000.00 (mm/min)	0 to 200000000 ($\times 10^{-2}$ mm/min)
1: inch	0 to 2000000.000 (inch/min)	0 to 200000000 ($\times 10^{-3}$ inch/min)
2: degree	0 to 3000000.000 (degree/min)	0 to 300000000 ($\times 10^{-3}$ degree/min)
3: pulse	0 to 5000000 (pulse/s)	0 to 5000000 (pulse/s)

*1 When this buffer memory area is set with programs, a calculation is performed in the positioning module to convert a setting value to the value in each unit. For setting this buffer memory area, take the value after the unit conversion into consideration.

■Default value

The default value is 0 for all the axes.

■Precautions for using a stepping motor

- For the system that uses a stepping motor, executing the S-curve acceleration/deceleration may cause step out. Before using the S-curve acceleration/deceleration, check that step out does not occur.
- In the system that uses a stepping motor, the circular interpolation control cannot be performed. Although setting the bias speed at start is required by the characteristics of the stepping motor, the setting of the bias speed at start is disabled for circular interpolation control. Use a servomotor for both axes when circular interpolation control is performed.

[Pr.62] Electronic gear selection

Select an electronic gear (16 bits or 32 bits) to use.

Electronic gear selection	Setting value
16 bits	0
32 bits	1

The addresses used by the buffer memory areas shown below depend on the setting of this area.

Setting value of [Pr.62] Electronic gear selection	Address of [Pr.2] No. of pulses per rotation	Address of [Pr.3] Movement amount per rotation
0: 16 bits	<ul style="list-style-type: none">• Axis 1: 1• Axis 2: 151	<ul style="list-style-type: none">• Axis 1: 2• Axis 2: 152
1: 32 bits	<ul style="list-style-type: none">• Axis 1: 102, 103• Axis 2: 252, 253	<ul style="list-style-type: none">• Axis 1: 104, 105• Axis 2: 254, 255

■ Buffer memory address

The following table shows the buffer memory address of this area.

Buffer memory name	Axis 1	Axis 2
[Pr.62] Electronic gear selection	100	250

■ Default value

The default value is 0: 16 bits for all the axes.

[Pr.2] No. of pulses per rotation (32 bits) (Ap)

Set the number of pulses required for a rotation of the motor shaft with 32 bits. When [Pr.62] Electronic gear selection is set to 1: 32 bits, this area is valid. When the resolution per rotation of the servomotor of the servo amplifier used exceeds 65535 pulses, set the number of pulses per rotation with this area.

■ Buffer memory address

The following table shows the buffer memory address of this area.

Buffer memory name	Axis 1	Axis 2
[Pr.2] No. of pulses per rotation (32 bits) (Ap)	102	252
	103	253

■ Setting range

The setting range is 1 to 200000000.

■ Default value

The default value is 20000 for all the axes.

[Pr.3] Movement amount per rotation (32 bits) (AI)

Set the distance of machine movement (movement amount) per rotation of the motor shaft with 32 bits. When [Pr.62] Electronic gear selection is set to 1: 32 bits, this area is valid. When the movement amount per rotation of the motor shaft exceeds the setting range of [Pr.3] Movement amount per rotation (16 bits) in the system used, use this area. When the movement amount per rotation is set with this area, the adjustment with [Pr.4] Unit magnification is unavailable.

■Buffer memory address

The following table shows the buffer memory address of this area.

Buffer memory name	Axis 1	Axis 2
[Pr.3] Movement amount per rotation (32 bits) (AI)	104	254
	105	255

■Setting range

The setting range depends on the setting of [Pr.1] Unit setting.

Setting of [Pr.1] Unit setting	Setting value via GX Works3	Setting value with programs ^{*1}
0: mm	0.1 to 20000000.0 (μm)	1 to 200000000 ($\times 10^{-1}\mu\text{m}$)
1: inch	0.00001 to 2000.00000 (inch)	1 to 200000000 ($\times 10^{-5}\text{inch}$)
2: degree	0.00001 to 2000.00000 (degree)	1 to 200000000 ($\times 10^{-5}\text{degree}$)
3: pulse	1 to 200000000 (pulse)	1 to 200000000 (pulse)

*1 When this buffer memory area is set with programs, a calculation is performed in the positioning module to convert a setting value to the value in each unit. For setting this buffer memory area, take the value after the unit conversion into consideration.

■Default value

The default value is 20000 for all the axes.

Basic parameter 2

This section describes the details on the basic parameter 2.

[Pr.8] Speed limit value

Set the maximum speed during positioning control and OPR control. If the specified speed exceeds the speed limit value, positioning is limited at the speed limit value.

Positioning control speed must be limited properly depending on the device and control subject.

When the command pulse frequency (pulse/s) converted from the speed limit value exceeds the maximum output pulse of the positioning module, Outside speed limit value range (Error code: 1A6AH) occurs. The maximum output pulse rate of the positioning module is 200 kpulse/s for the FX5-20PG-P and 5 Mpulse/s for the FX5-20PG-D.

■Buffer memory address

The following table shows the buffer memory address of this area.

Buffer memory name	Axis 1	Axis 2
[Pr.8] Speed limit value	10	160
	11	161

■Setting range

The setting range depends on the setting of [Pr.1] Unit setting.

Setting of [Pr.1] Unit setting	Setting value via GX Works3	Setting value with programs*1
0: mm	0.01 to 20000000.00 (mm/min)	1 to 2000000000 ($\times 10^{-2}$ mm/min)
1: inch	0.001 to 2000000.000 (inch/min)	1 to 2000000000 ($\times 10^{-3}$ inch/min)
2: degree	0.001 to 3000000.000 (degree/min)	1 to 3000000000 ($\times 10^{-3}$ degree/min)
3: pulse	1 to 5000000 (pulse/s)	1 to 5000000 (pulse/s)

*1 When this buffer memory area is set with programs, a calculation is performed in the positioning module to convert a setting value to the value in each unit. For setting this buffer memory area, take the value after the unit conversion into consideration.

■Default value

The default value is 200000 for all the axes.

[Pr.9] Acceleration time 0, [Pr.10] Deceleration time 0

For [Pr.9] Acceleration time 0, set the time for the speed to increase from 0 to [Pr.8] Speed limit value (to [Pr.31] JOG speed limit value during a JOG operation control) in units of ms. For [Pr.10] Deceleration time 0, set the time for the speed to decrease from [Pr.8] Speed limit value (from [Pr.31] JOG speed limit value during a JOG operation control) to 0 in units of ms.

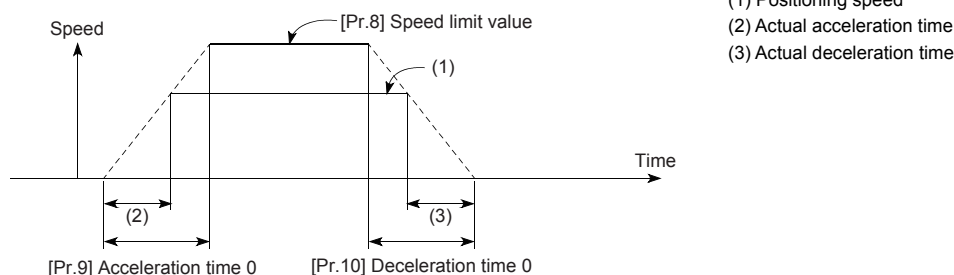

- When the set positioning speed is lower than the value set in [Pr.8] Speed limit value, the actual acceleration/deceleration time is shorter than the set value of the parameters. Thus, set the maximum positioning speed to a value equal to the value set in [Pr.8] Speed limit value or only a little lower value than the speed limit value.
- The settings in these areas are valid for OPR, positioning, and JOG operations.
- In the interpolation positioning, the acceleration/deceleration time set for the reference axis is valid.

■Buffer memory address

The following table shows the buffer memory address of this area.

Buffer memory name	Axis 1	Axis 2
[Pr.9] Acceleration time 0	12	162
	13	163
[Pr.10] Deceleration time 0	14	164
	15	165

■Setting range

The setting range is 1 to 8388608.

■Default value

The default value is 1000 for all the axes.

Detailed parameter 1

[Pr.11] Backlash compensation amount

The error that occurs due to backlash when the machine is moved via gears can be compensated.

(When the backlash compensation amount is set, pulses equivalent to the compensation amount is output each time the direction changes during the positioning.)

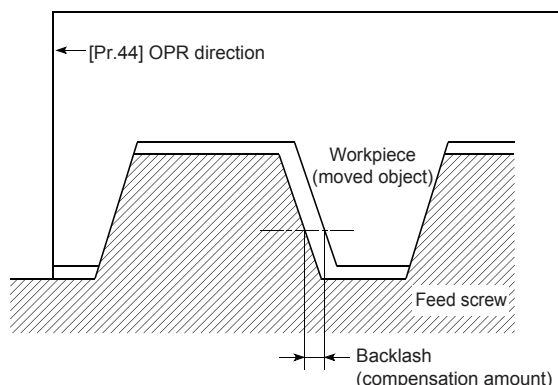

- The backlash compensation is valid after machine OPR. Thus, if the backlash compensation amount is set or changed, always perform machine OPR once.
- The setting range of the backlash compensation amount is 0 to 65535. Set the amount with the following condition satisfied. (Omit values after the decimal point)

$$0 \leq \frac{\text{Backlash compensation amount}}{\text{Movement amount per pulse}} \leq 255$$

■Buffer memory address

The following table shows the buffer memory address of this area.

Buffer memory name	Axis 1	Axis 2
[Pr.11] Backlash compensation amount	17	167

■Setting range

The setting range depends on the setting of [Pr.1] Unit setting.

Setting of [Pr.1] Unit setting	Setting value via GX Works3	Setting value with programs*1
0: mm	0 to 6553.5 (μm)	0 to 65535 (×10 ⁻¹ μm)
1: inch	0 to 0.65535 (inch)	0 to 65535 (×10 ⁻⁵ inch)
2: degree	0 to 0.65535 (degree)	0 to 65535 (×10 ⁻⁵ degree)
3: pulse	0 to 65535 (pulse)	0 to 65535 (pulse)

*1 When this buffer memory area is set with programs, a calculation is performed in the positioning module to convert a setting value to the value in each unit. For setting this buffer memory area, take the value after the unit conversion into consideration.

■Default value

The default value is 0 for all the axes.

[Pr.12] Software stroke limit upper limit value

Set the upper limit for the machine's movement range during positioning control.

■Buffer memory address

The following table shows the buffer memory address of this area.

Buffer memory name	Axis 1	Axis 2
[Pr.12] Software stroke limit upper limit value	18	168
	19	169

■Setting range

The setting range depends on the setting of [Pr.1] Unit setting.

Setting of [Pr.1] Unit setting	Setting value via GX Works3	Setting value with programs ^{*1}
0: mm	-214748364.8 to 214748364.7 (μm)	-2147483648 to 2147483647 ($\times 10^{-1}\mu\text{m}$)
1: inch	-21474.83648 to 21474.83647 (inch)	-2147483648 to 2147483647 ($\times 10^{-5}\text{inch}$)
2: degree	0 to 359.99999 (degree)	0 to 35999999 ($\times 10^{-5}\text{degree}$)
3: pulse	-2147483648 to 2147483647 (pulse)	-2147483648 to 2147483647 (pulse)

*1 When this buffer memory area is set with programs, a calculation is performed in the positioning module to convert a setting value to the value in each unit. For setting this buffer memory area, take the value after the unit conversion into consideration.

■Default value

The default value is 2147483647 for all the axes.

[Pr.13] Software stroke limit lower limit value

Set the lower limit for the machine's movement range during positioning control.

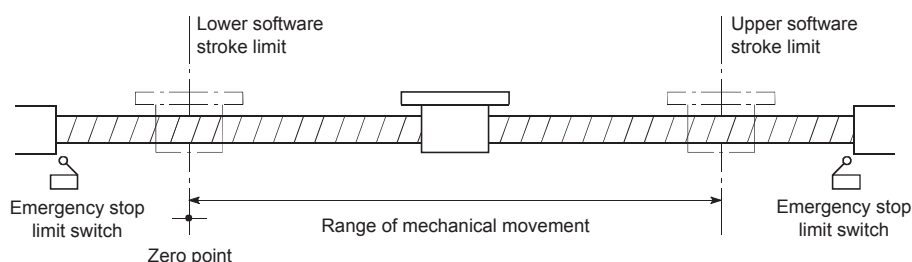

- In general, the OP is set at the lower limit or upper limit of the stroke limit.
- Setting the upper and lower limits of the software stroke limit prevents the workpiece to overrun the set range; although, in addition, place emergency stop limit switches outside and near the range.
- To invalidate the software stroke limit, set the setting value to Upper limit value = Lower limit value. (Set the value within the setting range, such as the initial value.)
- When the unit is degree, the software stroke limit check is invalid during speed control (including the speed control of speed-position switching control and position-speed switching control) or during manual control.

■Buffer memory address

The following table shows the buffer memory address of this area.

Buffer memory name	Axis 1	Axis 2
[Pr.13] Software stroke limit lower limit value	20	170
	21	171

■Setting range

The setting range is the same as that of [Pr.12] Software stroke limit upper limit value.

■Default value

The default value is -2147483648 for all the axes.

[Pr.14] Software stroke limit selection

Set whether to apply the software stroke limit to Current feed value or Machine feed value. The software stroke limit is validated according to the set value.

Software stroke limit selection	Setting value
Apply the software stroke limit to the current feed value	0
Apply the software stroke limit to the machine feed value	1

■Buffer memory address

The following table shows the buffer memory address of this area.

Buffer memory name	Axis 1	Axis 2
[Pr.14] Software stroke limit selection	22	172

■Default value

The default value is 0: Apply the software stroke limit to the current feed value for all the axes.

[Pr.15] Software stroke limit valid/invalid setting

Set whether to validate the software stroke limit during the JOG operation, inching operation, and manual pulse generator operation.

Software stroke limit valid/invalid setting	Setting value
Software stroke limit is valid during the JOG operation, inching operation, and manual pulse generator operation	0
Software stroke limit is invalid during the JOG operation, inching operation, and manual pulse generator operation	1

■Buffer memory address

The following table shows the buffer memory address of this area.

Buffer memory name	Axis 1	Axis 2
[Pr.15] Software stroke limit valid/invalid setting	23	173

■Default value

The default value is 0: Software stroke limit is valid during the JOG operation, inching operation, and manual pulse generator operation for all the axes.

[Pr.16] Command in-position width

Set the remaining distance that turns on the command in-position. The command in-position signal is used as a front-loading signal of the positioning complete signal. When positioning control starts, Command in-position flag (bit 2) in [Md.31] Status turns off, and Command in-position flag turns on at the set position of the command in-position signal.

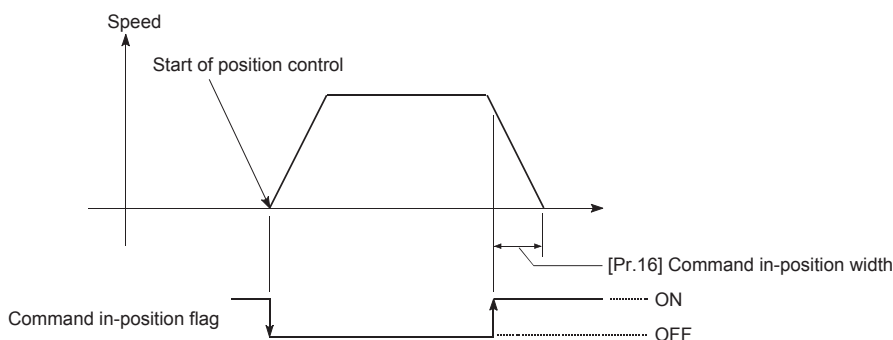

■ Buffer memory address

The following table shows the buffer memory address of this area.

Buffer memory name	Axis 1	Axis 2
[Pr.16] Command in-position width	24	174
	25	175

■ Setting range

The setting range depends on the setting of [Pr.1] Unit setting.

Setting of [Pr.1] Unit setting	Setting value via GX Works3	Setting value with programs*1
0: mm	0.1 to 214748364.7 (μm)	1 to 2147483647 ($\times 10^{-1} \mu\text{m}$)
1: inch	0.00001 to 21474.83647 (inch)	1 to 2147483647 ($\times 10^{-5}$ inch)
2: degree	0.00001 to 21474.83647 (degree)	1 to 2147483647 ($\times 10^{-5}$ degree)
3: pulse	1 to 2147483647 (pulse)	1 to 2147483647 (pulse)

*1 When this buffer memory area is set with programs, a calculation is performed in the positioning module to convert a setting value to the value in each unit. For setting this buffer memory area, take the value after the unit conversion into consideration.

■ Default value

The default value is 100 for all the axes.

[Pr.17] Torque limit setting value

Set the maximum value of the torque generated by the servomotor in units of %.

The torque limit function limits the torque generated by the servomotor within the set range.

If the torque required for control exceeds the torque limit value, the control is performed with the set torque limit value.

■ Buffer memory address

The following table shows the buffer memory address of this area.

Buffer memory name	Axis 1	Axis 2
[Pr.17] Torque limit setting value	26	176

■ Setting range

The setting range is 1 to 5000.

■ Default value

The default value is 300 for all the axes.

Restriction

Limits for the pulse train output type

- A drive unit that can issue a torque limit command with analog voltage is required.
- The D/A converter module and drive unit must be wired together.
- The set value in [Pr.17] Torque limit setting value is set for [Md.35] Torque limit stored value in the buffer memory. Transfer the value set in [Md.35] Torque limit stored value to the D/A converter module with programs.

[Pr.18] M code ON signal output timing

Set the timing of outputting the M code ON signal.

Select either the WITH mode or the AFTER mode as timing of outputting the M code ON signal.

WITH mode (setting value: 0)	AFTER mode (setting value: 1)
An M code is output and the M code ON signal ([Md.31] Status: b12) is turned on when a positioning operation starts.	An M code is output and the M code ON signal ([Md.31] Status: b12) is turned on when a positioning operation completes.

*1 m1 and m2 represent the configured M codes.

- An M code is a number between 0 and 65535 that can be assigned to each positioning data (shape).
- Programs can be coded to read the M code from [Md.25] Valid M code whenever the M code ON signal ([Md.31] Status: b12) turns on so that a command for sub works such as clamping, drilling, and tool change corresponding to the M code can be issued.
- When the AFTER mode is set in the speed control, the M code is not output and the M code ON signal ([Md.31] Status: b12) is not turned on.
- The M code ON signal output timing can be set for each positioning data with the positioning option ([Da.27] M code ON signal output timing) of the positioning data.

■ Buffer memory address

The following table shows the buffer memory address of this area.

Buffer memory name	Axis 1	Axis 2
[Pr.18] M code ON signal output timing	27	177

■ Default value

The default value is 0: WITH mode for all the axes.

[Pr.19] Speed switching mode

Select the speed switching mode between the standard switching and front-loading switching.

Speed switching mode	Setting value	Description
Standard speed switching mode	0	Switches the speed when executing the next positioning data.
Front-loading speed switching mode	1	Switches the speed at the end of the positioning data being executed.

■ Standard switching

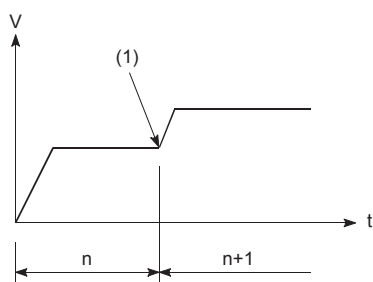

(1) Switches the speed when executing the next positioning data.
n: Positioning data No.

■ Front-loading switching

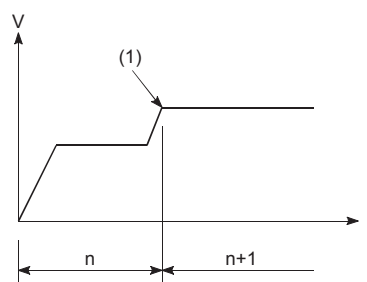

(1) The next positioning data starts the positioning operation at the specified speed.
n: Positioning data No.

■Buffer memory address

The following table shows the buffer memory address of this area.

Buffer memory name	Axis 1	Axis 2
[Pr.19] Speed switching mode	28	178

■Default value

The default value is 0: Standard speed switching mode for all the axes.

[Pr.20] Interpolation speed specification method

When performing linear interpolation/circular interpolation, set whether to specify the composite speed or the speed for the reference axis.

Interpolation speed specification method	Setting value	Description
Composite speed	0	The movement speed for the control target is specified, and the speed for each axis is calculated by the positioning module.
Reference axis speed	1	The axis speed set for the reference axis is specified, and the speed for the interpolation axis performing interpolation is calculated by the positioning module.

■When the composite speed is specified

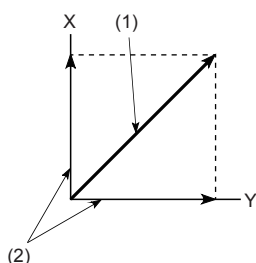

- (1) Specify the composite speed
(2) Positioning module performs calculation

■When the speed for the reference axis is specified

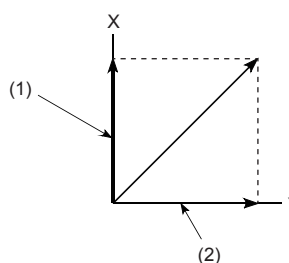

- (1) Specify the reference axis speed
(2) Positioning module performs calculation

- Specify the "1: Reference axis speed" when using 2-axis speed control. If "0: Composite speed" is specified, Interpolation mode error (Error code: 199AH) occurs when the positioning operation starts.
- Specify "0: Composite speed" when using circular interpolation control. If "1: Reference axis speed" is specified, Interpolation mode error (Error code: 199BH) occurs when the positioning operation starts.
- The interpolation speed specification method for each positioning data can be set with the positioning option ([Da.29] Interpolation speed specification method) of the positioning data.

■Buffer memory address

The following table shows the buffer memory address of this area.

Buffer memory name	Axis 1	Axis 2
[Pr.20] Interpolation speed specification method	29	179

■Default value

The default value is 0: Composite speed for all the axes.

[Pr.21] Current feed value during speed control

Specify whether to enable or disable the update of [Md.20] Current feed value while operations are performed under the speed control (including the speed control of speed-position switching control and position-speed switching control).

Current feed value during speed control	Setting value	Description
Current feed value is not updated	0	The current feed value does not change. (The current feed value during speed control start is maintained.)
Update current feed value	1	The current feed value is updated. (The current feed value changes from the initial value.)
Current feed value is cleared to zero	2	The current feed is set to 0 and does not change from 0 while the speed control is performed.

- When the speed control is performed over two axes, the selection between enabling and disabling the update of [Md.20] Current feed value depends on how the reference axis is set.
- Set 1: Update current feed value to perform the speed-position switching control (ABS mode).

■Buffer memory address

The following table shows the buffer memory address of this area.

Buffer memory name	Axis 1	Axis 2
[Pr.21] Current feed value during speed control	30	180

■Default value

The default value is 0: Current feed value is not updated for all the axes.

[Pr.22] Input signal logic selection

Set the logic of each input signal according to the external device.

Input signal logic selection	Setting value
Negative logic	0
Positive logic	1

The following table shows the assignment of each input signal. Set a value for the target bit.

Buffer memory	Assignment of input signals	
b15 b14 b13 b12 b11 b10 b9 b8 b7 b6 b5 b4 b3 b2 b1 b0	b0	Lower limit signal
0 0 0 0 0 0 0 0 0 0 0 0 0 0 0 0	b1	Upper limit signal
	b2	Drive unit READY signal
	b3	Stop signal
	b4	External command signal
	b5	Zero signal
	b6	Near-point dog signal
	b7	Use prohibited (fixed to 0)
	b8	Manual pulse generator input
	b9 to b15	Use prohibited (fixed to 0)

- A mismatch in the signal logic will disable normal operation. Be careful of this when the setting is changed from the initial value.
- Set the logic selection (b8) of the manual pulse generator input for the axis 1. (Settings are ignored when set to axis 2.)

■Buffer memory address

The following table shows the buffer memory address of this area.

Buffer memory name	Axis 1	Axis 2
[Pr.22] Input signal logic selection	31	181

■Default value

Each input signal of all the axes is set to 0: Negative logic.

[Pr.23] Output signal logic selection

Set the logic of each output signal according to the external device.

Output signal logic selection	Setting value
Negative logic	0
Positive logic	1

The following table shows the assignment of each output signal. Set a value for the target bit.

Buffer memory	Assignment of input signals	
b15 b14 b13 b12 b11 b10 b9 b8 b7 b6 b5 b4 b3 b2 b1 b0	b0	Command pulse signal
0 0 0 0 0 0 0 0 0 0 0 0 0 0 0 0	b1 to b3	Use prohibited
	b4	Deviation counter clear signal
	b5 to b15	Use prohibited

A mismatch in the signal logic will disable normal operation. Be careful of this when the setting is changed from the initial value.

■Buffer memory address

The following table shows the buffer memory address of this area.

Buffer memory name	Axis 1	Axis 2
[Pr.23] Output signal logic selection	32	182

■Default value

Each input signal of all the axes is set to 0: Negative logic.

[Pr.24] Manual pulse generator input selection

Set the input pulse mode from the manual pulse generator. (Only the setting value specified for the axis 1 is valid.)

Manual pulse generator input selection	Setting value
A-phase/B-phase multiple of 4	0
A-phase/B-phase multiple of 2	1
A-phase/B-phase multiple of 1	2
PULSE/SIGN	3

■Buffer memory address

The following table shows the buffer memory address of this area.

Buffer memory name	Axis 1	Axis 2
[Pr.24] Manual pulse generator input selection	33	—

■Default value

The default value is 0: A-phase/B-phase multiple of 4.

[Pr.150] Speed-position function selection

Select the mode of speed-position switching control.

Speed-position function selection	Setting value
Speed-position switching control (INC mode)	0
Speed-position switching control (ABS mode)	2

If a value other than 0 and 2 is set, the control is performed in the INC mode with the setting value regarded as 0.

■Buffer memory address

The following table shows the buffer memory address of this area.

Buffer memory name	Axis 1	Axis 2
[Pr.150] Speed-position function selection	34	184

■Default value

The default value is 0: Speed-position switching control (INC mode) for all the axes.

Detailed parameter 2

[Pr.25] Acceleration time 1 to [Pr.27] Acceleration time 3

Set the time for the speed to increase from 0 to [Pr.8] Speed limit value (to [Pr.31] JOG speed limit value during a JOG operation control) during positioning. The specifications of this area are the same as those of [Pr.9] Acceleration time 0. For details, refer to the following.

☞ Page 395 [Pr.9] Acceleration time 0, [Pr.10] Deceleration time 0

■Buffer memory address

The following table shows the buffer memory address of this area.

Buffer memory name	Axis 1	Axis 2
[Pr.25] Acceleration time 1	36	186
	37	187
[Pr.26] Acceleration time 2	38	188
	39	189
[Pr.27] Acceleration time 3	40	190
	41	191

■Setting range

The setting range is 1 to 8388608.

■Default value

The default value is 1000 for all the axes.

[Pr.28] Deceleration time 1 to [Pr.30] Deceleration time 3

Set the time for the speed to decrease from [Pr.8] Speed limit value (from [Pr.31] JOG speed limit value during a JOG operation control) to zero during positioning. The specifications of this area are the same as those of [Pr.10] Deceleration time 0. For details, refer to the following.

☞ Page 395 [Pr.9] Acceleration time 0, [Pr.10] Deceleration time 0

■Buffer memory address

The following table shows the buffer memory address of this area.

Buffer memory name	Axis 1	Axis 2
[Pr.28] Deceleration time 1	42	192
	43	193
[Pr.29] Deceleration time 2	44	194
	45	195
[Pr.30] Deceleration time 3	46	196
	47	197

■Setting range

The setting range is 1 to 8388608.

■Default value

The default value is 1000 for all the axes.

[Pr.31] JOG speed limit value

Set the maximum speed for the JOG operation.

Set the value in JOG speed limit value to a value equal to or less than the value set in [Pr.8] Speed limit value. If the value exceeds the value set in Speed limit value, JOG speed limit value error (Error code: 1AB8H) occurs.

■Buffer memory address

The following table shows the buffer memory address of this area.

Buffer memory name	Axis 1	Axis 2
[Pr.31] JOG speed limit value	48	198
	49	199

■Setting range

The setting range depends on the setting of [Pr.1] Unit setting.

Setting of [Pr.1] Unit setting	Setting value via GX Works3	Setting value with programs*1
0: mm	0.01 to 20000000.00 (mm/min)	1 to 2000000000 ($\times 10^{-2}$ mm/min)
1: inch	0.001 to 2000000.000 (inch/min)	1 to 2000000000 ($\times 10^{-3}$ inch/min)
2: degree	0.001 to 3000000.000 (degree/min)	1 to 3000000000 ($\times 10^{-3}$ degree/min)
3: pulse	1 to 5000000 (pulse/s)	1 to 5000000 (pulse/s)

*1 When this buffer memory area is set with programs, a calculation is performed in the positioning module to convert a setting value to the value in each unit. For setting this buffer memory area, take the value after the unit conversion into consideration.

■Default value

The default value is 20000 for all the axes.

[Pr.32] JOG operation acceleration time selection

Set which of Acceleration time 0 to 3 to use for the acceleration time during JOG operation.

JOG operation acceleration time selection	Setting value	Description
Acceleration time 0	0	Uses the value set in [Pr.9] Acceleration time 0.
Acceleration time 1	1	Uses the value set in [Pr.25] Acceleration time 1.
Acceleration time 2	2	Uses the value set in [Pr.26] Acceleration time 2.
Acceleration time 3	3	Uses the value set in [Pr.27] Acceleration time 3.

■Buffer memory address

The following table shows the buffer memory address of this area.

Buffer memory name	Axis 1	Axis 2
[Pr.32] JOG operation acceleration time selection	50	200

■Default value

The default value is 0: Acceleration time 0 for all the axes.

[Pr.33] JOG operation deceleration time selection

Set which of Deceleration time 0 to 3 to use for the deceleration time during JOG operation.

JOG operation deceleration time selection	Setting value	Description
Deceleration time 0	0	Use the value set in [Pr.10] Deceleration time 0.
Deceleration time 1	1	Use the value set in [Pr.28] Deceleration time 1.
Deceleration time 2	2	Use the value set in [Pr.29] Deceleration time 2.
Deceleration time 3	3	Use the value set in [Pr.30] Deceleration time 3.

■Buffer memory address

The following table shows the buffer memory address of this area.

Buffer memory name	Axis 1	Axis 2
[Pr.33] JOG operation deceleration time selection	51	201

■Default value

The default value is 0: Deceleration time 0 for all the axes.

[Pr.34] Acceleration/deceleration processing selection

Set whether to use the trapezoidal acceleration/deceleration processing or S-curve acceleration/deceleration processing for the acceleration/deceleration processing.

Acceleration/deceleration processing selection	Setting value
Trapezoidal acceleration/deceleration processing	0
S-curve acceleration/deceleration processing	1

■Trapezoidal acceleration/deceleration
Acceleration and deceleration occur linearly.

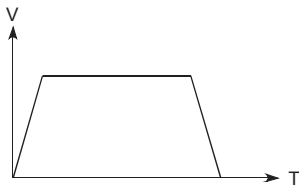

■S-curve acceleration/deceleration
Acceleration and deceleration occur as a sine curve.

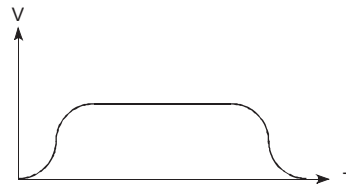

For the system that uses a stepping motor, executing the S-curve acceleration/deceleration may cause step out. Before using the S-curve acceleration/deceleration, check that step out does not occur.

■Buffer memory address

The following table shows the buffer memory address of this area.

Buffer memory name	Axis 1	Axis 2
[Pr.34] Acceleration/deceleration processing selection	52	202

■Default value

The default value is 0: Trapezoidal acceleration/deceleration processing for all the axes.

[Pr.35] S-curve ratio

Set the S-curve ratio (1 to 100%) for performing the S-curve acceleration/deceleration processing.

The S-curve ratio indicates where to draw the acceleration/deceleration curve using the sine curve as shown below.

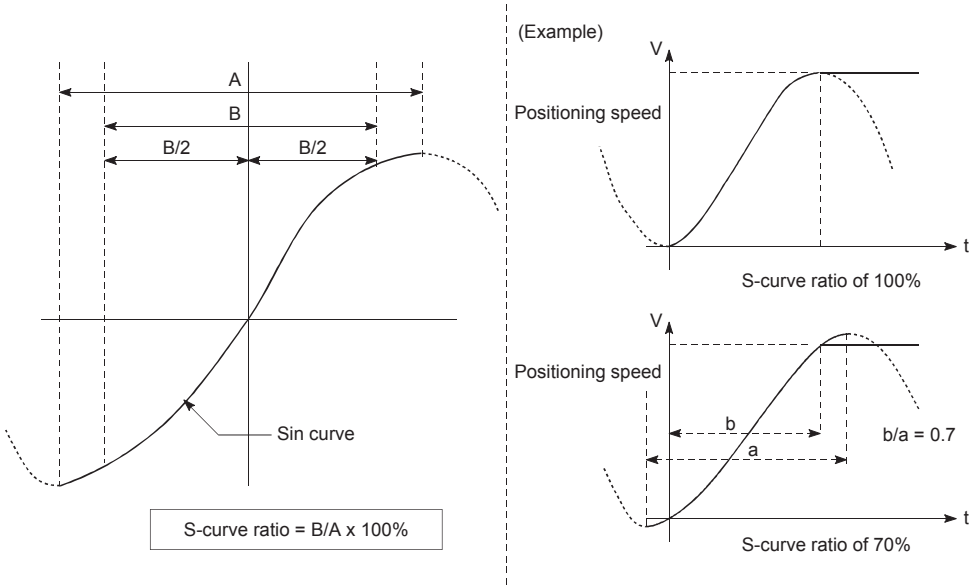

■Buffer memory address

The following table shows the buffer memory address of this area.

Buffer memory name	Axis 1	Axis 2
[Pr.35] S-curve ratio	53	203

■Setting range

The setting range is 1 to 100.

■Default value

The default value is 100 for all the axes.

[Pr.36] Sudden stop deceleration time

Set the time for the speed to decrease from [Pr.8] Speed limit value (from [Pr.31] JOG speed limit value during a JOG operation control) to 0 at a sudden stop in units of ms. Set this parameter to stop (sudden stop) operations in a shorter time than the deceleration time for positioning when a stop cause occurs. Stop causes are classified into stop cause 1 to 3. The stop cause for a sudden stop can be selected with the setting of [Pr.37] Stop group 1 sudden stop selection setting to [Pr.39] Stop group 3 sudden stop selection.

The following figure shows the relation with other parameters.

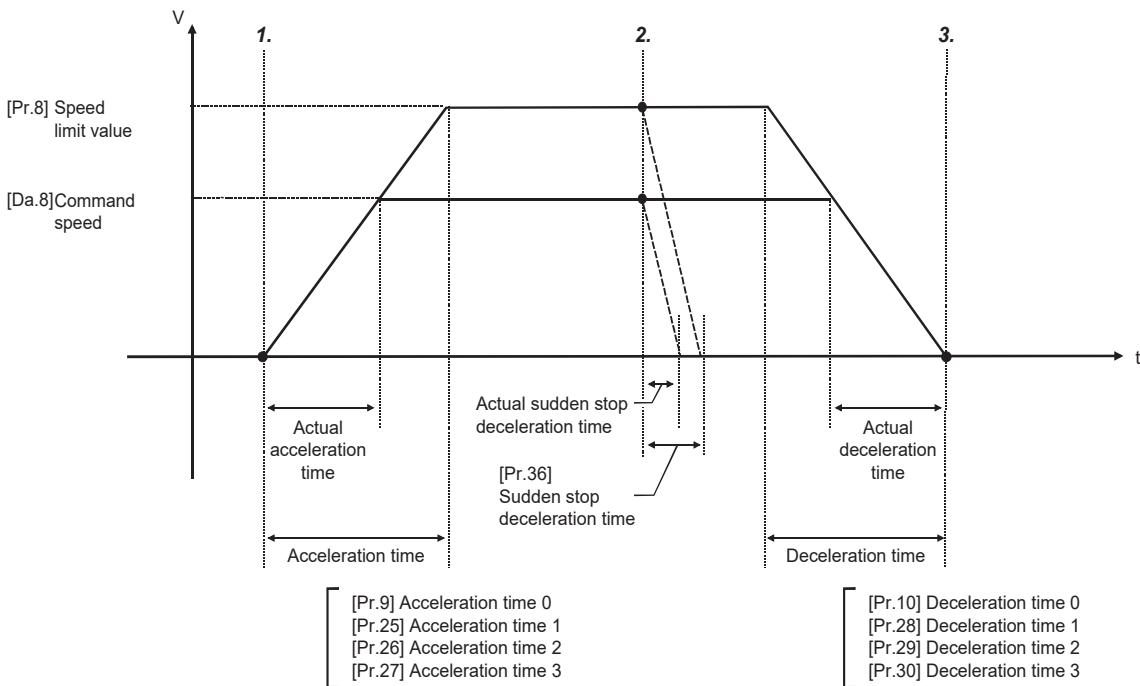

1. Positioning start

Acceleration starts via the positioning start per the configured acceleration time.

2. Occurrence of sudden stop factor

Deceleration starts per the sudden stop deceleration time when a sudden stop factor occurs.

3. Positioning stop

Deceleration starts per the deceleration time toward the stop position when there is no occurrence of a sudden stop factor.

■Buffer memory address

The following table shows the buffer memory address of this area.

Buffer memory name	Axis 1	Axis 2
[Pr.36] Sudden stop deceleration time	54	204
	55	205

■Setting range

The setting range is 1 to 8388608.

■Default value

The default value is 1000 for all the axes.

[Pr.37] to [Pr.39] Stop group 1 to 3 sudden stop selection

Set the method to stop operations when the stop causes in the following stop groups occur.

- Stop group 1: Stop with the hardware stroke limit
- Stop group 2: CPU module error occurrence, [Cd.190] PLC READY signal off, fault in the test mode
- Stop group 3: External stop signal, Stop signal from the CPU module, Stop signal from GX Works3, Error occurrence (Excluding errors in stop groups 1 and 2. Including only the software stroke limit errors during JOG operation, speed control, speed-position switching control, and position-speed switching control), Error at operation mode switching in amplifier-less operation

The methods of stopping include 0: Normal deceleration stop and 1: Sudden stop.

Stop group 1 sudden stop selection	Setting value
Normal deceleration stop	0
Sudden stop	1

If 1: Sudden stop is selected, the axis suddenly decelerates to a stop according to the setting of [Pr.36] Sudden stop deceleration time when a stop cause occurs.

■Buffer memory address

The following table shows the buffer memory address of this area.

Buffer memory name	Axis 1	Axis 2
[Pr.37] Stop group 1 sudden stop selection	56	206
[Pr.38] Stop group 2 sudden stop selection	57	207
[Pr.39] Stop group 3 sudden stop selection	58	208

■Default value

The default value is 0: Normal deceleration stop for all the axes.

[Pr.40] Positioning complete signal output time

Set the output time of Positioning complete signal ([Md.31] Status: b15) output from the positioning module in units of ms. A positioning completes when the set dwell time is elapsed after the positioning module terminates outputting pulses. For the interpolation control, Positioning completed signal of interpolation axis is output only for the time set to the reference axis.

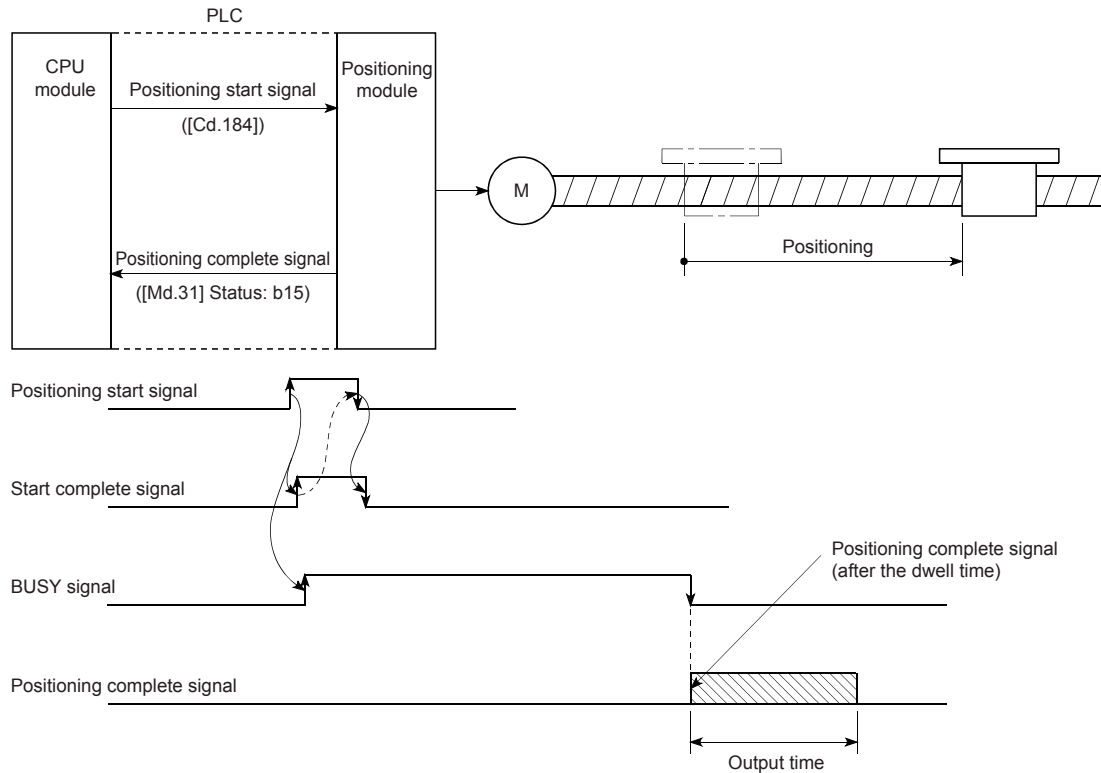

■ Buffer memory address

The following table shows the buffer memory address of this area.

Buffer memory name	Axis 1	Axis 2
[Pr.40] Positioning complete signal output time	59	209

■ Setting range

The setting range is 0 to 65535.

■ Default value

The default value is 300 for all the axes.

[Pr.41] Allowable circular interpolation error width

For Allowable circular interpolation error width, set the allowable error range of the calculated arc path and end point address. If the error of the calculated arc path and end point address is within the setting range, circular interpolation is performed to the set end point address while the error is compensated with spiral interpolation.

The allowable circular interpolation error width is set in the buffer memory addresses of the reference axis.

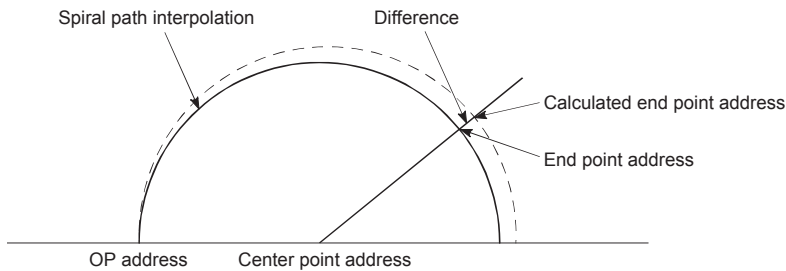

In the circular interpolation control using the center point specification, the arc path calculated with the start point address and center point address and the end point address may deviate.

■ Buffer memory address

The following table shows the buffer memory address of this area.

Buffer memory name	Axis 1	Axis 2
[Pr.41] Allowable circular interpolation error width	60	210
	61	211

■ Setting range

The setting range depends on the setting of [Pr.1] Unit setting.

Setting of [Pr.1] Unit setting	Setting value via GX Works3	Setting value with programs*1
0: mm	0 to 10000.0 (μm)	0 to 100000 ($\times 10^{-1}\mu\text{m}$)
1: inch	0 to 1.00000 (inch)	0 to 100000 ($\times 10^{-5}\text{inch}$)
2: degree	0 to 1.00000 (degree)	0 to 100000 ($\times 10^{-5}\text{degree}$)
3: pulse	0 to 100000 (pulse)	0 to 100000 (pulse)

*1 When this buffer memory area is set with programs, a calculation is performed in the positioning module to convert a setting value to the value in each unit. For setting this buffer memory area, take the value after the unit conversion into consideration.

■ Default value

The default value is 100 for all the axes.

[Pr.42] External command function selection

Select a function with which external command signals are associated.

External command function selection	Setting value	Description
Start with external command	0	Starts a positioning operation by inputting an external command signal.
External speed change request	1	Changes the speed in the current positioning operation by inputting an external command signal. Set a new speed value in [Cd.14] New speed value.
Speed-position/position-speed switching request	2	Switches the control from speed control→position control in the speed-position switching control, or from position control→speed control in the position-speed switching control by inputting an external command signal. To enable speed-position switching, set [Cd.24] Speed-position switching enable flag to 1. To enable position-speed switching, set [Cd.26] Position-speed switching enable flag to 1.
Skip request	3	Skips the current positioning operation by inputting an external command signal.

■Buffer memory address

The following table shows the buffer memory address of this area.

Buffer memory name	Axis 1	Axis 2
[Pr.42] External command function selection	62	212

■Default value

The default value is 0: Start with external command for all the axes.



To enable the external command signal, [Cd.8] External command valid must be set to 1.

[Pr.82] Start adjustment time

Set the amount of time from when a positioning start trigger signal is input to when it starts outputting pulses in units of ms with Quick start function. The actual time elapsed before a pulse output starts depends on the start trigger.

- Start via external command signal: $20 \mu\text{s} + [\text{Pr.82}] \text{ Start adjustment time}$
- Start via positioning start signal: $30 \mu\text{s} + "[\text{Pr.82}] \text{ Start adjustment time}"$

■Buffer memory address

The following table shows the buffer memory address of this area.

Buffer memory name	Axis 1	Axis 2
[Pr.82] Start adjustment time	134	284
	135	285

■Setting range

The following table shows the setting range.

Setting value via GX Works3	Setting value with programs
0.00 to 10000.00 (ms)	0 to 1000000 ($\times 10^{-2}$ ms)

■Default value

The default value is 0 for all the axes.

OPR basic parameter

[Pr.43] OPR method

Set OPR method for performing the machine OPR.

OPR method	Setting value	Description	Reference
Near-point dog method	0	After the speed of the OPR is decelerated when the near-point dog is on, the OPR stops when the zero signal is detected and the machine OPR completes.	Page 83
Stopper method 1	1	After the speed of the OPR is decelerated when the near-point dog is on, the OPR stops with the stopper and the OPR completes when the dwell time is elapsed.	Page 85
Stopper method 2	2	After the speed of the OPR is decelerated when the near-point dog is on, the OPR stops with the stopper and the machine OPR completes when the zero signal is detected.	Page 88
Stopper method 3	3	After the OPR starts at the creep speed, the OPR stops with the stopper and the machine OPR completes when the zero signal is detected.	Page 91
Count method 1	4	After the speed of the OPR is decelerated when the near-point dog is on, the OPR stops when the zero signal is detected after the workpiece is moved for the specified distance, and the machine OPR completes.	Page 93
Count method 2	5	After the speed of the OPR is decelerated when the near-point dog is on, the workpiece is moved for the specified distance and the machine OPR completes.	Page 95
Data setting method	6	The position where the machine OPR starts is set as the OP, and the machine OPR completes.	Page 97
Limit switch combined-use method	7	After the speed of the OPR is decelerated when the limit switch is turned off, the machine moves in the direction opposite to the OPR direction, the OPR stops when the zero signal is detected after the limit switch is turned on, and the machine OPR is completed.	Page 98

■Buffer memory address

The following table shows the buffer memory address of this area.

Buffer memory name	Axis 1	Axis 2
[Pr.43] OPR method	70	220

■Default value

The default value is 0: Near-point dog method for all the axes.

[Pr.44] OPR direction

Set the direction of the movement when the machine OPR starts.

OPR direction	Setting value	Description
Forward direction (address increment)	0	Moves the workpiece in the address increment direction. (Arrow (2))
Reverse direction (address decrement)	1	Moves the workpiece in the address decrement direction. (Arrow (1))

Because the OP is normally set near the lower limit or the upper limit, [Pr.44] OPR direction is set as follows.

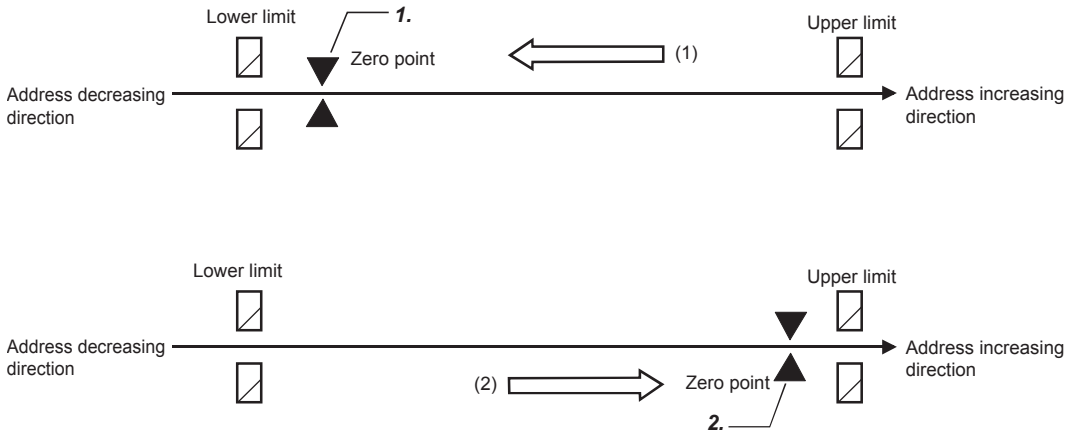

1. The direction of zero point return is as indicated by arrow (1) when the zero point is set near the lower limit. Set [Pr.44] to "1".
2. The direction of zero point return is as indicated by arrow (2) when the zero point is set near the upper limit. Set [Pr.44] to "0".

■Buffer memory address

The following table shows the buffer memory address of this area.

Buffer memory name	Axis 1	Axis 2
[Pr.44] OPR direction	71	221

■Default value

The default value is 0: Forward direction (address increment) for all the axes.

[Pr.45] OP address

Set the address used as the reference point for positioning control (ABS system).

(When the machine OPR is completed, the stop position address is changed to the address set in [Pr.45] OP address. At the same time, the value set in [Pr.45] OP address is stored in [Md.20] Current feed value and [Md.21] Machine feed value.)

■Buffer memory address

The following table shows the buffer memory address of this area.

Buffer memory name	Axis 1	Axis 2
[Pr.45] OP address	72	222
	73	223

■Setting range

The setting range depends on the setting of [Pr.1] Unit setting.

Setting of [Pr.1] Unit setting	Setting value via GX Works3	Setting value with programs*1
0: mm	-214748364.8 to 214748364.7 (μm)	-2147483648 to 2147483647 ($\times 10^{-1}\mu\text{m}$)
1: inch	-21474.83648 to 21474.83647 (inch)	-2147483648 to 2147483647 ($\times 10^{-5}\text{inch}$)
2: degree	0 to 359.99999 (degree)	0 to 35999999 ($\times 10^{-5}\text{degree}$)
3: pulse	-2147483648 to 2147483647 (pulse)	-2147483648 to 2147483647 (pulse)

*1 When this buffer memory area is set with programs, a calculation is performed in the positioning module to convert a setting value to the value in each unit. For setting this buffer memory area, take the value after the unit conversion into consideration.

■Default value

The default value is 0 for all the axes.

[Pr.46] OPR speed

Set the speed for OPR.

Set OPR speed to a value equal to or less than the value set in [Pr.8] Speed limit value. If the value exceeds the value set in Speed limit value, OPR speed error (Error code: 1B04H) occurs and the OPR is not performed.

Set OPR speed to a value equal to or more than the values set in [Pr.7] Bias speed at start and [Pr.47] Creep speed.

■Buffer memory address

The following table shows the buffer memory address of this area.

Buffer memory name	Axis 1	Axis 2
[Pr.46] OPR speed	74	224
	75	225

■Setting range

The setting range depends on the setting of [Pr.1] Unit setting.

Setting of [Pr.1] Unit setting	Setting value via GX Works3	Setting value with programs*1
0: mm	0.01 to 20000000.00 (mm/min)	1 to 2000000000 ($\times 10^{-2}\text{mm/min}$)
1: inch	0.001 to 2000000.000 (inch/min)	1 to 2000000000 ($\times 10^{-3}\text{inch/min}$)
2: degree	0.001 to 3000000.000 (degree/min)	1 to 3000000000 ($\times 10^{-3}\text{degree/min}$)
3: pulse	1 to 5000000 (pulse/s)	1 to 5000000 (pulse/s)

*1 When this buffer memory area is set with programs, a calculation is performed in the positioning module to convert a setting value to the value in each unit. For setting this buffer memory area, take the value after the unit conversion into consideration.

■Default value

The default value is 1 for all the axes.

[Pr.47] Creep speed

Once the near-point dog turns on, the control decelerates from OPR speed and stops. Set the speed of right before the stop, which is a creep speed. Set the creep speed within the following range.

- ([Pr.46] OPR speed) \geq ([Pr.47] Creep speed) \geq ([Pr.7] Bias speed at start)

The creep speed is related to the detection error in the OPR method using the zero signal, and to the size of the shock when a collision occurs in the OPR method using the stopper method.

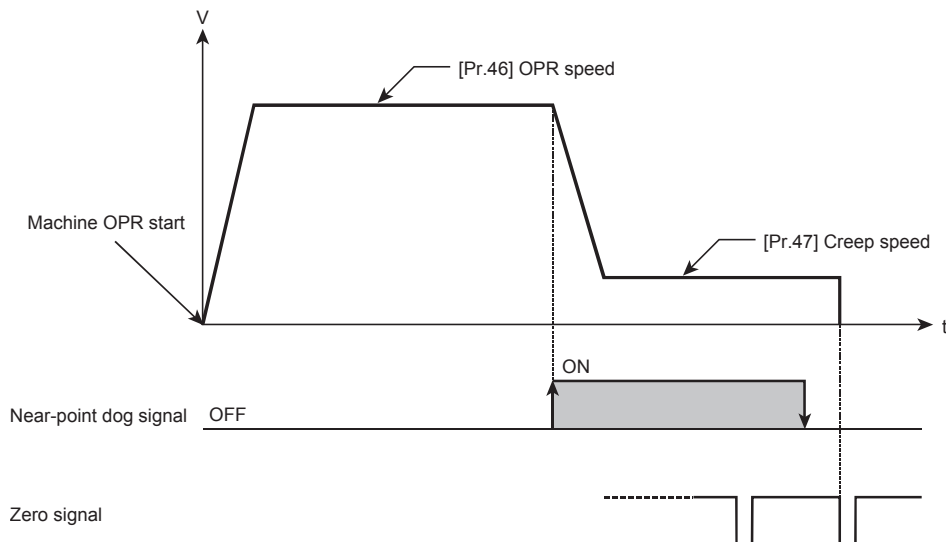

■ Buffer memory address

The following table shows the buffer memory address of this area.

Buffer memory name	Axis 1	Axis 2
[Pr.47] Creep speed	76	226
	77	227

■ Setting range

The setting range depends on the setting of [Pr.1] Unit setting.

Setting of [Pr.1] Unit setting	Setting value via GX Works3	Setting value with programs ^{*1}
0: mm	0.01 to 20000000.00 (mm/min)	1 to 2000000000 ($\times 10^{-2}$ mm/min)
1: inch	0.001 to 2000000.000 (inch/min)	1 to 2000000000 ($\times 10^{-3}$ inch/min)
2: degree	0.001 to 3000000.000 (degree/min)	1 to 3000000000 ($\times 10^{-3}$ degree/min)
3: pulse	1 to 5000000 (pulse/s)	1 to 5000000 (pulse/s)

*1 When this buffer memory area is set with programs, a calculation is performed in the positioning module to convert a setting value to the value in each unit. For setting this buffer memory area, take the value after the unit conversion into consideration.

■ Default value

The default value is 1 for all the axes.

[Pr.48] OPR retry

Set whether to perform OPR retry.

OPR retry	Setting value
Do not perform OPR retry by limit switch	0
Perform OPR retry by limit switch	1

For the operation of OPR retry, refer to the following.

 Page 220 OPR retry function

■Buffer memory address

The following table shows the buffer memory address of this area.

Buffer memory name	Axis 1	Axis 2
[Pr.48] OPR retry	78	228

■Default value

The default value is 0: Do not perform OPR retry by limit switch for all the axes.

OPR detailed parameter

[Pr.49] OPR dwell time

When stopper method 1 is set in [Pr.43] OPR method set the time for the machine OPR to complete after the near-point dog signal turns on in units of ms. Set a value equal to or greater than the movement time from the near-point dog signal ON to the stop with the stopper. (If the OPR method is not Stopper method 1, the value in [Pr.49] OPR dwell time is irrelevant.)

■Buffer memory address

The following table shows the buffer memory address of this area.

Buffer memory name	Axis 1	Axis 2
[Pr.49] OPR dwell time	79	229

■Setting range

The setting range is 0 to 65535.

■Default value

The default value is 0 for all the axes.

[Pr.50] Setting for the movement amount after near-point dog ON

When the OPR method is count method 1 or 2, set the movement amount from the position where the near-point dog signal turns on to the OP.

(Set the value for the movement amount after near-point dog ON to a value equal to or greater than the sum of the "distance covered by the deceleration from the OPR speed to the creep speed" and "distance of movement in 10 ms at the OPR speed".)

Ex.

Setting example of [Pr.50] Setting for the movement amount after near-point dog ON

The [Pr.50] Setting for the movement amount after near-point dog ON is calculated as follows when [Pr.8] Speed limit value is set to 200 kpulse/s, [Pr.46] OPR speed is set to 10 kpulse/s, [Pr.47] Creep speed is set to 1 kpulse/s, and the deceleration time is set to 300 ms.

[Machine OPR operation]

[Pr.8] Speed control value: $V_p = 200$ kpulse/s

[Pr.46] OPR speed: $V_z = 10$ kpulse/s

[Pr.47] Creep speed: $V_c = 1$ kpulse/s

Actual deceleration time: $t = T_b \times \frac{V_z}{V_p}$

Deceleration time: $T_b = 300$ ms

$$\begin{aligned}
 \text{[Deceleration distance]} &= \frac{1}{2} \times \frac{V_z}{1000} \times t + 0.01 \times V_z \\
 &= \frac{V_z}{2000} \times \frac{T_b \times V_z}{V_p} + 0.01 \times V_z \\
 &= \frac{10 \times 10^3}{2000} \times \frac{300 \times 10 \times 10^3}{200 \times 10^3} + 0.01 \times 10 \times 10^3 \\
 &= 75 + 100 \\
 &= 175 \\
 &\downarrow \\
 &\text{Set "[Pr.50] Setting for the movement amount after near-point dog ON" to a value of at least 175.}
 \end{aligned}$$

■ Buffer memory address

The following table shows the buffer memory address of this area.

Buffer memory name	Axis 1	Axis 2
[Pr.50] Setting for the movement amount after near-point dog ON	80	230
	81	231

■ Setting range

The setting range depends on the setting of [Pr.1] Unit setting.

Setting of [Pr.1] Unit setting	Setting value via GX Works3	Setting value with programs*1
0: mm	0 to 214748364.7 (μm)	0 to 2147483647 ($\times 10^{-1} \mu\text{m}$)
1: inch	0 to 21474.83647 (inch)	0 to 2147483647 ($\times 10^{-5}$ inch)
2: degree	0 to 21474.83647 (degree)	0 to 2147483647 ($\times 10^{-5}$ degree)
3: pulse	0 to 2147483647 (pulse)	0 to 2147483647 (pulse)

*1 When this buffer memory area is set with programs, a calculation is performed in the positioning module to convert a setting value to the value in each unit. For setting this buffer memory area, take the value after the unit conversion into consideration.

■ Default value

The default value is 0 for all the axes.

[Pr.51] OPR acceleration time selection

Set which of Acceleration time 0 to 3 to use for the acceleration time during OPR.

OPR acceleration time selection	Setting value	Description
Acceleration time 0	0	Uses the value set in [Pr.9] Acceleration time 0.
Acceleration time 1	1	Uses the value set in [Pr.25] Acceleration time 1.
Acceleration time 2	2	Uses the value set in [Pr.26] Acceleration time 2.
Acceleration time 3	3	Uses the value set in [Pr.27] Acceleration time 3.

■Buffer memory address

The following table shows the buffer memory address of this area.

Name	Axis 1	Axis 2
[Pr.51] OPR acceleration time selection	82	232

■Default value

The default value is 0: Acceleration time 0 for all the axes.

[Pr.52] OPR deceleration time selection

Set which of Deceleration time 0 to 3 to use for the deceleration time during OPR.

OPR deceleration time selection	Setting value	Description
Deceleration time 0	0	Uses the value set in [Pr.10] Deceleration time 0.
Deceleration time 1	1	Uses the value set in [Pr.28] Deceleration time 1.
Deceleration time 2	2	Uses the value set in [Pr.29] Deceleration time 2.
Deceleration time 3	3	Uses the value set in [Pr.30] Deceleration time 3.

■Buffer memory address

The following table shows the buffer memory address of this area.

Name	Axis 1	Axis 2
[Pr.52] OPR deceleration time selection	83	233

■Default value

The default value is 0: Deceleration time 0 for all the axes.

[Pr.53] OP shift amount

Set the amount to shift (move) the OP from the stop position with machine OPR.

The OP shift function is used to compensate the OP position stopped with machine OPR.

If the OP position is physically limited due to the installation position of the near-point dog, use this function to compensate the OP to an optimum position.

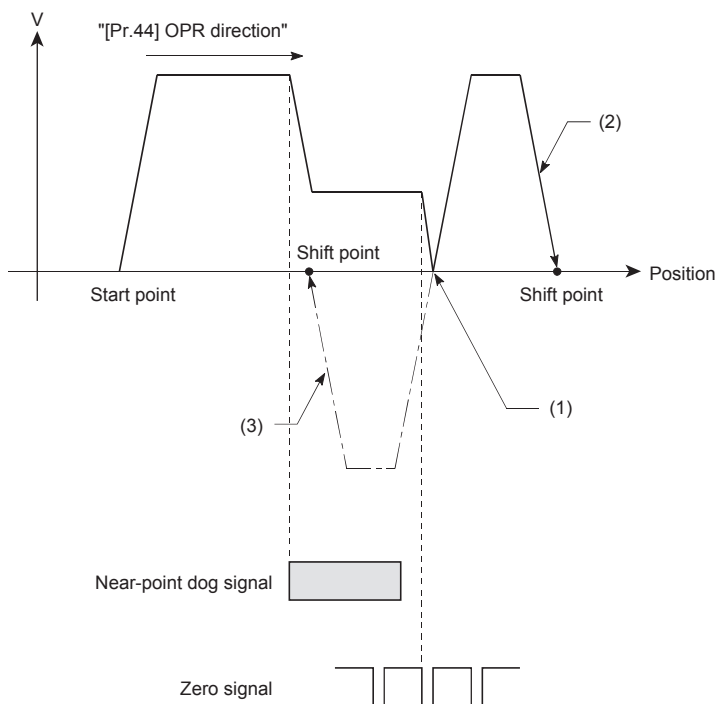

(1) Perform the shift operation after the deviation counter clear is released.

(2) When "[Pr.53] OP shift amount" is positive

(3) When "[Pr.53] OP shift amount" is negative

■Buffer memory address

The following table shows the buffer memory address of this area.

Buffer memory name	Axis 1	Axis 2
[Pr.53] OP shift amount	84	234
	85	235

■Setting range

The setting range depends on the setting of [Pr.1] Unit setting.

Setting of [Pr.1] Unit setting	Setting value via GX Works3	Setting value with programs ^{*1}
0: mm	-214748364.8 to 214748364.7 (μm)	-2147483648 to 2147483647 ($\times 10^{-1}\mu\text{m}$)
1: inch	-21474.83648 to 21474.83647 (inch)	-2147483648 to 2147483647 ($\times 10^{-5}\text{inch}$)
2: degree	-21474.83648 to 21474.83647 (degree)	-21474.83648 to 21474.83647 ($\times 10^{-5}\text{degree}$)
3: pulse	-2147483648 to 2147483647 (pulse)	-2147483648 to 2147483647 (pulse)

*1 When this buffer memory area is set with programs, a calculation is performed in the positioning module to convert a setting value to the value in each unit. For setting this buffer memory area, take the value after the unit conversion into consideration.

■Default value

The default value is 0 for all the axes.

[Pr.54] OPR torque limit value

Set the value to limit the servomotor torque after the creep speed is reached during machine OPR in units of %. If the torque is not limited, the servomotor may be in failure.

When the value set in [Pr.54] OPR torque limit value exceeds the value set in [Pr.17] Torque limit setting value, OPR torque limit value error (Error code: 1B0EH) occurs.

For details on the torque limit, refer to the following.

☞ Page 239 Torque limit function

■Buffer memory address

The following table shows the buffer memory address of this area.

Buffer memory name	Axis 1	Axis 2
[Pr.54] OPR torque limit value	86	236

■Setting range

The setting range is 1 to 3000.

■Default value

The default value is 300 for all the axes.

[Pr.55] Deviation counter clear signal output time

Set the time for outputting the deviation counter clear signal during a machine OPR operation using any of the following methods in units of ms: the near-point dog method, stopper method 1 to 3, count method 1, data setting method, and Limit switch combined-use method. (For details, refer to the manual of the drive unit used.)

■Buffer memory address

The following table shows the buffer memory address of this area.

Buffer memory name	Axis 1	Axis 2
[Pr.55] Deviation counter clear signal output time	87	237

■Setting range

The setting range is 1 to 65535.

■Default value

The default value is 11 for all the axes.

[Pr.56] Speed specification during OP shift

Set the operation speed for when a value other than 0 is set in [Pr.53] OP shift amount. Select the setting from [Pr.46] OPR speed or [Pr.47] Creep speed.

Speed specification during OP shift	Setting value	Description
OPR speed	0	Specifies the value set in [Pr.46] OPR speed as the setting value.
Creep speed	1	Specifies the value set in [Pr.47] Creep speed as the setting value.

■Buffer memory address

The following table shows the buffer memory address of this area.

Buffer memory name	Axis 1	Axis 2
[Pr.56] Speed specification during OP shift	88	238

■Default value

The default value is 0: OPR speed for all the axes.

[Pr.57] Dwell time during OPR retry

When OPR retry is performed, set the stop time after the deceleration of (2) and (4) in the following figure in units of ms.

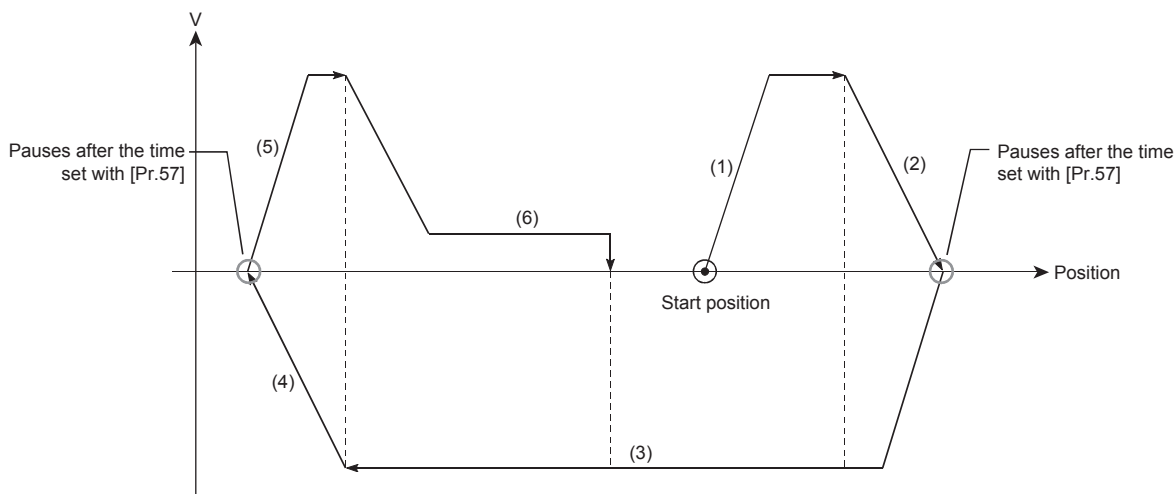

■Buffer memory address

The following table shows the buffer memory address of this area.

Buffer memory name	Axis 1	Axis 2
[Pr.57] Dwell time during OPR retry	89	239

■Setting range

The setting range is 0 to 65535.

■Default value

The default value is 0 for all the axes.

[Pr.58] Setting of operation during uncompleted OPR

Set whether or not to execute the positioning control when OPR request flag ([Md.31] Status: b3) is on.

Setting of operation during uncompleted OPR	Setting value
Do not execute the positioning control	0
Execute the positioning control	1

■Buffer memory address

The following table shows the buffer memory address of this area.

Buffer memory name	Axis 1	Axis 2
[Pr.58] Setting of operation during uncompleted OPR	90	240

■Default value

The default value is 0: Do not execute the positioning control for all the axes.

17.4 Positioning Data

The following figure shows the configuration of the positioning data stored in the buffer memory of the positioning module.

Positioning data No.	1	2	3	...	599	600
Positioning identifier [Da.1] - [Da.5]	2000	2010	2020	...	7980	7990
[Da.10] M code	2001	2011	2021	...	7981	7991
[Da.9] Dwell time	2002	2012	2022	...	7982	7992
Positioning option [Da.27] - [Da.29]	2003	2013	2023	...	7983	7993
[Da.8] Command speed	2004 2005	2014 2015	2024 2025	...	7984 7985	7994 7995
[Da.6] Positioning address/movement amount	2006 2007	2016 2017	2026 2027	...	7986 7987	7996 7997
[Da.7] Arc address	2008 2009	2018 2019	2028 2029	...	7988 7989	7998 7999

- Up to 600 positioning data registrations per axis can be configured (stored) via buffer memory addresses as illustrated in the left figure. This data is organized and managed using positioning data numbers 1 through 600 per axis.
- Each positioning data registration is configured with multiple parameters in a positioning data number as illustrated by the .

Positioning data No.	1	2	3	...	599	600
Positioning identifier [Da.1] - [Da.5]	8000	8010	8020	...	13980	13990
[Da.10] M code	8001	8011	8021	...	13981	13991
[Da.9] Dwell time	8002	8012	8022	...	13982	13992
Positioning option [Da.27] - [Da.29]	8003	8013	8023	...	13983	13993
[Da.8] Command speed	8004 8005	8014 8015	8024 8025	...	13984 13985	13994 13995
[Da.6] Positioning address/movement amount	8006 8007	8016 8017	8026 8027	...	13986 13987	13996 13997
[Da.7] Arc address	8008 8009	8018 8019	8028 8029	...	13988 13989	13998 13999

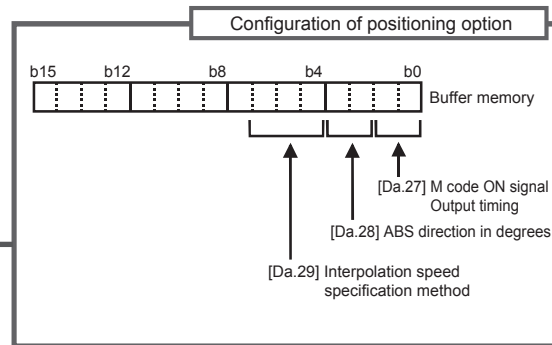
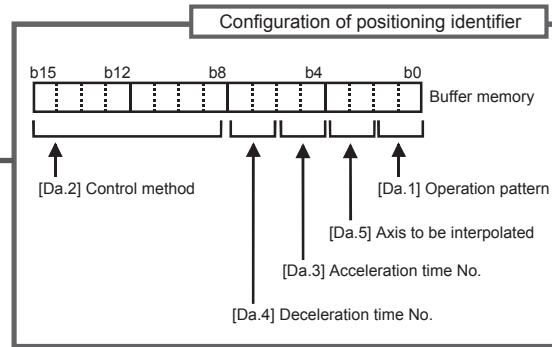

Each axis has 600 positioning data (No.1 to No. 600).

[Da.1] Operation pattern

The operation pattern is used to specify whether to end the positioning of a certain data number with just that data or to perform the positioning of the next data number in succession.

Operation pattern	Setting value	Description
Positioning Complete	00	Set this value to execute the positioning to the specified address to complete the positioning.
Continuous positioning control	01	Performs the positioning successively in order of data numbers with one start signal. The operation stops at each position indicated by one positioning data.
Continuous path control	11	Performs the positioning successively in order of data numbers with one start signal. The operation does not stop at each position indicated by one positioning data.

■ Configuration of positioning identifier

The positioning identifier consists of [Da.1] Operation pattern to [Da.5] Axis to be interpolated. These five setting values are stored in a buffer memory address. Set the values in [Da.1] Operation pattern to [Da.5] Axis to be interpolated according to the configuration of positioning identifier shown in the following figure.

Configuration of positioning identifier	Assignment	
	(1)	[Da.1] Operation pattern
	(2)	[Da.5] Axis to be interpolated
	(3)	[Da.3] Acceleration time No.
	(4)	[Da.4] Deceleration time No.
	(5)	[Da.2] Control method

■ Buffer memory address

For the buffer memory address of this area, refer to the following.

☞ Page 552 Positioning data

■ Default value

The default value is 00 for all the axes.

[Da.2] Control method

Set Control method for performing the positioning control. The following table lists the available control methods.

Control method	Setting value
ABS1: 1-axis linear control (ABS)	01H
INC1: 1-axis linear control (INC)	02H
FEED1: 1-axis fixed-feed control	03H
VF1: 1-axis speed control (forward run)	04H
VR1: 1-axis speed control (reverse run)	05H
VPF: Speed-position switching control (forward run)	06H
VPR: Speed-position switching control (reverse run)	07H
PVF: Position-speed switching control (forward run)	08H
PVR: Position-speed switching control (reverse run)	09H
ABS2: 2-axis linear interpolation control (ABS)	0AH
INC2: 2-axis linear interpolation control (INC)	0BH
FEED2: Fixed-feed control by 2-axis linear interpolation	0CH
ABS \frown : Circular interpolation control with sub point specified (ABS)	0DH
INC \frown : Circular interpolation control with sub point specified (INC)	0EH
ABS.: Circular interpolation control with center point specified (ABS, CW)	0FH
ABS.: Circular interpolation control with center point specified (ABS, CCW)	10H
INC.: Circular interpolation control with center point specified (INC, CW)	11H
INC.: Circular interpolation control with center point specified (INC, CCW)	12H
VF2: 2-axis speed control (forward run)	13H
VR2: 2-axis speed control (reverse run)	14H
NOP: NOP instruction	80H
POS: Current value change	81H
JUMP: JUMP instruction	82H
LOOP: Beginning of LOOP-to-LEND processing	83H
LEND: End of LOOP-to-LEND processing	84H

For the setting, refer to the following and check the assignment of this area.

 Page 424 Configuration of positioning identifier

■Buffer memory address

For the buffer memory address of this area, refer to the following.

 Page 552 Positioning data

■Default value

The default value is 00H for all the axes.

Restriction

- When JUMP instruction is set for the control method, the setting values in [Da.9] Dwell time and [Da.10] M code differ from the values when another control method is set.
- When LOOP is set for the control method, the setting value in [Da.10] M code differs from the value when another control method is set.
- When "2: degree" is set in [Pr.1] Unit setting, the circular interpolation control cannot be executed. Circular interpolation not possible (Error code: 199FH) occurs when the control is executed.

[Da.3] Acceleration time No.

Set which of Acceleration time 0 to 3 to use for the acceleration time during positioning.

Acceleration time No.	Setting value	Description
Acceleration time 0	00	Uses the value set in [Pr.9] Acceleration time 0.
Acceleration time 1	01	Uses the value set in [Pr.25] Acceleration time 1.
Acceleration time 2	10	Uses the value set in [Pr.26] Acceleration time 2.
Acceleration time 3	11	Uses the value set in [Pr.27] Acceleration time 3.

For the setting, refer to the following and check the assignment of this area.

☞ Page 424 Configuration of positioning identifier

■Buffer memory address

For the buffer memory address of this area, refer to the following.

☞ Page 552 Positioning data

■Default value

The default value is 00 for all the axes.

[Da.4] Deceleration time No.

Set which of Deceleration time 0 to 3 to use for the deceleration time during positioning.

Deceleration time No.	Setting value	Description
Deceleration time 0	00	Uses the value set in [Pr.10] Deceleration time 0.
Deceleration time 1	01	Uses the value set in [Pr.28] Deceleration time 1.
Deceleration time 2	10	Uses the value set in [Pr.29] Deceleration time 2.
Deceleration time 3	11	Uses the value set in [Pr.30] Deceleration time 3.

For the setting, refer to the following and check the assignment of this area.

☞ Page 424 Configuration of positioning identifier

■Buffer memory address

For the buffer memory address of this area, refer to the following.

☞ Page 552 Positioning data

■Default value

The default value is 00 for all the axes.

[Da.5] Axis to be interpolated

For operations under the 2-axis interpolation control, set Axis to be interpolated (partner axis).

Axis to be interpolated	Setting value	Description
Axis 1 specification	00	Selects the axis 1 as the axis to be interpolated (partner axis).
Axis 2 specification	01	Selects the axis 2 as the axis to be interpolated (partner axis).

- An axis which does not exist and the self-axis cannot be set as the axis to be interpolated. Illegal interpolation description command (Error code: 1A22H) occurs when executed.

For the setting, refer to the following and check the assignment of this area.

☞ Page 424 Configuration of positioning identifier

■Buffer memory address

For the buffer memory address of this area, refer to the following.

☞ Page 552 Positioning data

■Default value

The default value is 00 for all the axes.

[Da.6] Positioning address/movement amount

Set the address used as the target value for positioning control.

The setting range differs according to the value set in [Da.2] Control method.

■Absolute (ABS) system and current value change

Set the value (positioning address) with an absolute address (address from the OP) for the ABS system and current value change.

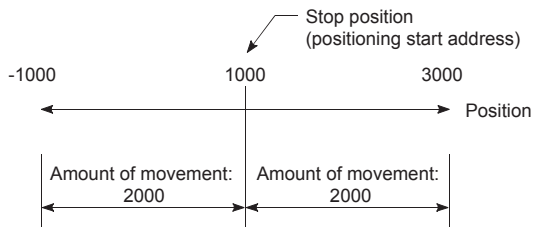

■Incremental (INC) system, fixed-feed 1, fixed-feed 2

Set the value (movement amount) with a sign for the INC system.

- Movement amount is positive: Movement occurs in the forward direction (address increment).
- Movement amount is negative: Movement occurs in the reverse direction (address increment).

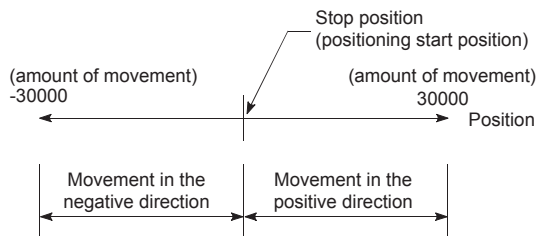

■Speed-position switching control

- INC mode: Set the movement amount after the control method is switched from the speed control to the position control.
- ABS mode: Set the absolute address which is to be the target value after the control method is switched from the speed control to the position control. (The unit is degree only.)

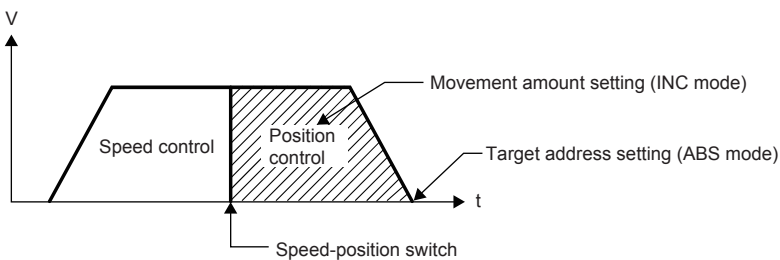

■Position-speed switching control

Set the movement amount in the position control (before switched to the speed control).

■Buffer memory address

For the buffer memory address of this area, refer to the following.

☞ Page 552 Positioning data

■ Setting range

The setting range depends on the setting of [Pr.1] Unit setting and [Da.2] Control method.

- When [Pr.1] Unit setting is "0: mm"

Setting of [Da.2] Control method ^{*1}	Setting value via GX Works3	Setting value with programs
ABS linear 1: 01H ABS linear 2: 0AH New current value: 81H	Set the address. -214748364.8 to 214748364.7 (μm)	Set the address. -2147483648 to 2147483647 (×10 ⁻¹ μm)
INC linear 1: 02H INC linear 2: 0BH Fixed-feed 1: 03H Fixed-feed 2: 0CH	Set the movement amount. -214748364.8 to 214748364.7 (μm)	Set the movement amount. -2147483648 to 2147483647 (×10 ⁻¹ μm)
Forward run speed-position: 06H Reverse run speed-position: 07H Forward run position-speed: 08H Reverse run position-speed: 09H	Set the movement amount. 0 to 214748364.7 (μm)	Set the movement amount. 0 to 2147483647 (×10 ⁻¹ μm)
ABS circular sub: 0DH ABS circular right: 0FH ABS circular left: 10H	Set the address. -214748364.8 to 214748364.7 (μm)	Set the address. -2147483648 to 2147483647 (×10 ⁻¹ μm)
INC circular sub: 0EH INC circular right: 11H INC circular left: 12H	Set the movement amount. -214748364.8 to 214748364.7 (μm)	Set the movement amount. -2147483648 to 2147483647 (×10 ⁻¹ μm)

*1 With any control method excluded from the table above, the positioning address and the movement amount do not need to be set.

- When [Pr.1] Unit setting is "2: degree"

Setting of [Da.2] Control method ^{*2}	Setting value via GX Works3	Setting value with programs
ABS linear 1: 01H ABS linear 2: 0AH New current value: 81H	Set the address. 0 to 359.99999 (degree)	Set the address. 0 to 35999999 (×10 ⁻⁵ degree)
INC linear 1: 02H INC linear 2: 0BH Fixed-feed 1: 03H Fixed-feed 2: 0CH	Set the movement amount. -21474.83648 to 21474.83647 (degree)	Set the movement amount. -2147483648 to 2147483647 (×10 ⁻⁵ degree)
Forward run speed-position: 06H Reverse run speed-position: 07H	Set the movement amount in the INC mode. 0 to 21474.83647 (degree)	Set the movement amount in the INC mode. 0 to 2147483647 (×10 ⁻⁵ degree)
	Set the address in the ABS mode. 0 to 359.99999 (degree)	Set the address in the ABS mode. 0 to 35999999 (×10 ⁻⁵ degree)
Forward run position-speed: 08H Reverse run position-speed: 09H	Set the movement amount. 0 to 21474.83647 (degree)	Set the movement amount. 0 to 2147483647 (×10 ⁻⁵ degree)

*2 With any control method excluded from the table above, the positioning address and the movement amount do not need to be set.

- When [Pr.1] Unit setting is "3: pulse"

Setting of [Da.2] Control method ^{*3}	Setting value via GX Works3	Setting value with programs
ABS linear 1: 01H ABS linear 2: 0AH New current value: 81H	Set the address. -2147483648 to 2147483647 (pulse)	Set the address. -2147483648 to 2147483647 (pulse)
INC linear 1: 02H INC linear 2: 0BH Fixed-feed 1: 03H Fixed-feed 2: 0CH	Set the movement amount. -2147483648 to 2147483647 (pulse)	Set the movement amount. -2147483648 to 2147483647 (pulse)
Forward run speed-position: 06H Reverse run speed-position: 07H Forward run position-speed: 08H Reverse run position-speed: 09H	Set the movement amount. 0 to 2147483647 (pulse)	Set the movement amount. 0 to 2147483647 (pulse)
ABS circular sub: 0DH ABS circular right: 0FH ABS circular left: 10H	Set the address. -2147483648 to 2147483647 (pulse)	Set the address. -2147483648 to 2147483647 (pulse)
INC circular sub: 0EH INC circular right: 11H INC circular left: 12H	Set the movement amount. -2147483648 to 2147483647 (pulse)	Set the movement amount. -2147483648 to 2147483647 (pulse)

*3 With any control method excluded from the table above, the positioning address and the movement amount do not need to be set.

- When [Pr.1] Unit setting is "1: inch"

Setting of [Da.2] Control method*4	Setting value via GX Works3	Setting value with programs
ABS linear 1: 01H ABS linear 2: 0AH New current value: 81H	Set the address. -21474.83648 to 21474.83647 (inch)	Set the address. -2147483648 to 2147483647 ($\times 10^{-5}$ inch)
INC linear 1: 02H INC linear 2: 0BH Fixed-feed 1: 03H Fixed-feed 2: 0CH	Set the movement amount. -21474.83648 to 21474.83647 (inch)	Set the movement amount. -2147483648 to 2147483647 ($\times 10^{-5}$ inch)
Forward run speed-position: 06H Reverse run speed-position: 07H Forward run position-speed: 08H Reverse run position-speed: 09H	Set the movement amount. 0 to 21474.83647 (inch)	Set the movement amount. 0 to 2147483647 ($\times 10^{-5}$ inch)
ABS circular sub: 0DH ABS circular right: 0FH ABS circular left: 10H	Set the address. -21474.83648 to 21474.83647 (inch)	Set the address. -2147483648 to 2147483647 ($\times 10^{-5}$ inch)
INC circular sub: 0EH INC circular right: 11H INC circular left: 12H	Set the movement amount. -21474.83648 to 21474.83647 (inch)	Set the movement amount. -2147483648 to 2147483647 ($\times 10^{-5}$ inch)

*4 With any control method excluded from the table above, the positioning address and the movement amount do not need to be set.

Default value

The default value is 0 for all the axes.

[Da.7] Arc address

The arc address is the data required only when the circular interpolation control is performed.

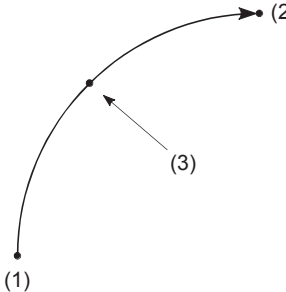
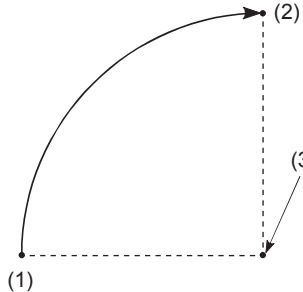
Circular interpolation with sub point specified	Circular interpolation with center point specified
<p>When the circular interpolation with sub point specified is performed, set the sub point (passing point) address as the arc address.</p>  <p>(1) Start point address (address before positioning starts) (2) End address (address set with [Da.6]) (3) Sub point (address set with [Da.7])</p>	<p>When the circular interpolation with center point specified is performed, set the center point address of the arc as the arc address.</p>  <p>(1) Start point address (address before positioning starts) (2) End address (address set with [Da.6]) (3) Center point address (address set with [Da.7])</p>

When the circular interpolation control is not performed, the value set in [Da.7] Arc address is invalid.

Buffer memory address

For the buffer memory address of this area, refer to the following.

☞ Page 552 Positioning data

Setting range

The setting range depends on the setting of [Pr.1] Unit setting and [Da.2] Control method.

- When [Pr.1] Unit setting is "0: mm"

Setting of [Da.2] Control method	Setting value via GX Works3	Setting value with programs
ABS circular sub: 0DH ABS circular right: 0FH ABS circular left: 10H	Set the address. -214748364.8 to 214748364.7 (μm)	Set the address. -2147483648 to 2147483647 ($\times 10^{-1}$ μm)
INC circular sub: 0EH INC circular right: 11H INC circular left: 12H	Set the movement amount. -214748364.8 to 214748364.7 (μm)*1	Set the movement amount. -2147483648 to 2147483647 ($\times 10^{-1}$ μm)*1

*1 Note that the maximum available radius in the circular interpolation control is 536870912, although the value of the arc address can be input within the range in the table above.

- When [Pr.1] Unit setting is "2: degree"

No control method requires the setting of the arc address with degree.

- When [Pr.1] Unit setting is "3: pulse"

Setting of [Da.2] Control method	Setting value via GX Works3	Setting value with programs
ABS circular sub: 0DH ABS circular right: 0FH ABS circular left: 10H	Set the address. -2147483648 to 2147483647 (pulse)	Set the address. -2147483648 to 2147483647 (pulse)
INC circular sub: 0EH INC circular right: 11H INC circular left: 12H	Set the movement amount. -2147483648 to 2147483647 (pulse) ^{*2}	Set the movement amount. -2147483648 to 2147483647 (pulse) ^{*2}

*2 Note that the maximum available radius in the circular interpolation control is 536870912, although the value of the arc address can be input within the range in the table above.

- When [Pr.1] Unit setting is "1: inch"

Setting of [Da.2] Control method	Setting value via GX Works3	Setting value with programs
ABS circular sub: 0DH ABS circular right: 0FH ABS circular left: 10H	Set the address. -21474.83648 to 21474.83647 (inch)	Set the address. -2147483648 to 2147483647 ($\times 10^{-5}$ inch)
INC circular sub: 0EH INC circular right: 11H INC circular left: 12H	Set the movement amount. -21474.83648 to 21474.83647 (inch) ^{*3}	Set the movement amount. -2147483648 to 2147483647 ($\times 10^{-5}$ inch) ^{*3}

*3 Note that the maximum available radius in the circular interpolation control is 536870912, although the value of the arc address can be input within the range in the table above.

■Default value

The default value is 0 for all the axes.

[Da.8] Command speed

Set the command speed for positioning.

- When the set command speed exceeds the value set in [Pr.8] Speed limit value, positioning is performed at the speed limit value.
- When the command speed is set to -1, the positioning control is performed at the current speed (speed set for previous positioning data No.). Use the current speed for continuous path control and other controls. If -1 is set for continuing positioning data, and the speed is changed, the following speed will also change. Note that when positioning starts, if the speed -1 is set for the positioning data that performs positioning control first, No command speed (Error code: 1A12H) occurs, and the positioning does not start.

■Buffer memory address

For the buffer memory address of this area, refer to the following.

 Page 552 Positioning data

■Setting range

The setting range depends on the setting of [Pr.1] Unit setting.

Setting of [Pr.1] Unit setting	Setting value via GX Works3	Setting value with programs ^{*1}
0: mm	0.01 to 20000000.00 (mm/min)	1 to 200000000 ($\times 10^{-2}$ mm/min)
1: inch	0.001 to 2000000.000 (inch/min)	1 to 200000000 ($\times 10^{-3}$ inch/min)
2: degree	0.001 to 3000000.000 (degree/min)	1 to 300000000 ($\times 10^{-3}$ degree/min)
3: pulse	1 to 5000000 (pulse/s)	1 to 5000000 (pulse/s)

*1 When this buffer memory area is set with programs, a calculation is performed in the positioning module to convert a setting value to the value in each unit. For setting this buffer memory area, take the value after the unit conversion into consideration.

■Default value

The default value is 0 for all the axes.

[Da.9] Dwell time

Set Dwell time or Positioning data No. according to the value set in [Da.2] Control method.

- When a method other than JUMP instruction is set in [Da.2] Control method, set the value in Dwell time in units of ms.
- When JUMP instruction is set in [Da.2] Control method, set Positioning data No. for the JUMP destination.

The dwell time is the time between the command pulse output is completed to the positioning complete signal is turned on. Set this time to absorb the delay of machine systems to the command, such as the delay (deviation) of the servo system. When Dwell time is set, the setting details of Dwell time are as follows according to the value set in [Da.1] Operation pattern.

(1) When [Da.1] Operation pattern is 00: Positioning complete

Set the time from when the positioning ends to when Positioning complete signal ([Md.31] Status: b15) turns on as the dwell time.

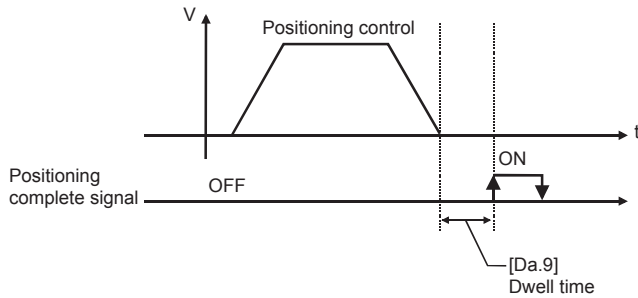

(2) When [Da.1] Operation pattern is 01: Continuous positioning control

Set the time from when the positioning control ends to when the next positioning control starts as the dwell time.

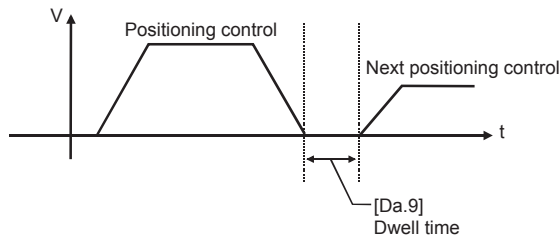

(3) When [Da.1] Operation pattern is 11: Continuous path control

The setting value is irrelevant to the control. The dwell time is 0 ms.

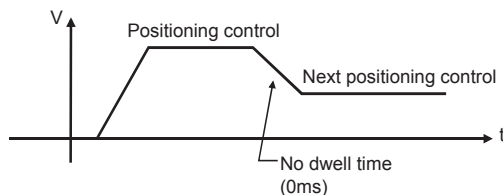

■Buffer memory address

For the buffer memory address of this area, refer to the following.

☞ Page 552 Positioning data

■Setting range

The setting range depends on the setting of [Da.2] Control method.

Setting of [Da.2] Control method	Setting value	Setting detail
JUMP instruction: 82H	1 to 600	Positioning data No.
Other than JUMP instruction	0 to 65535 (ms)	Dwell time

■Default value

The default value is 0 for all the axes.

[Da.10] M code

Set M code, Condition data No., or Number of LOOP to LEND repetitions depending on how [Da.2] Control method is set.

- If a method other than JUMP instruction and LOOP is selected as the setting value in [Da.2] Control method, set M code. If M code does not need to be output, set 0 (default value).
- If JUMP instruction is selected as the setting value in [Da.2] Control method, set Condition data No. for JUMP. When 0 is set, an unconditional JUMP is performed to the positioning data specified by the value set in [Da.9] Dwell time. When 1 to 10 is set, JUMP is performed according to the condition data No. specified (a number between 1 and 10).
- If LOOP is selected as the setting value in [Da.2] Control method, set the number of LOOP to LEND repetitions. If 0 is set, Control method LOOP setting error (Error code: 1A33H) occurs.

■Buffer memory address

For the buffer memory address of this area, refer to the following.

☞ Page 552 Positioning data

■Setting range

The setting range depends on the setting of [Da.2] Control method.

Setting of [Da.2] Control method	Setting value	Setting detail
JUMP instruction: 82H	0 to 10	Condition data No.
LOOP: 83H	1 to 65535	Number of repetitions
Other than the above	0 to 65535	M code

■Default value

The default value is 0 for all the axes.

[Da.27] M code ON signal output timing

Set the M code ON signal output timing for each positioning data.

M code ON signal output timing	Setting value
Use the setting value in [Pr.18] M code ON signal output timing	0
WITH mode	1
AFTER mode	2

For details on the settings, refer to the following.

☞ Page 400 [Pr.18] M code ON signal output timing

■Configuration of positioning option

The positioning option consists of [Da.27] M code ON signal output timing to [Da.29] Interpolation speed specification method. These three setting values are stored in a buffer memory address. Set the values in [Da.27] M code ON signal output timing to [Da.29] Interpolation speed specification method according to the configuration of positioning option shown in the following figure.

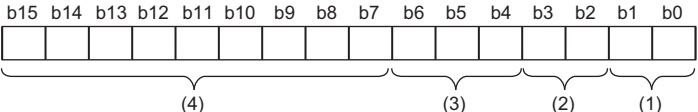
Configuration of positioning option	Assignment
	(1) [Da.27] M code ON signal output timing
	(2) [Da.28] ABS direction in degrees
	(3) [Da.29] Interpolation speed specification method
	(4) Use prohibited (fixed to 0)

■Buffer memory address

For the buffer memory address of this area, refer to the following.

☞ Page 552 Positioning data

■Default value

The default value is 0: Use the setting value in [Pr.18] M code ON signal output timing for all the axes.

[Da.28] ABS direction in degrees

Set the ABS movement direction for each positioning data when the unit is degree.

ABS direction in degrees	Setting value
Use the setting value in [Cd.40] ABS direction in degrees	0
ABS clockwise	1
ABS counterclockwise	2
Shortcut (Direction setting invalid)	3

For the setting, refer to the following and check the assignment of this area.

☞ Page 432 Configuration of positioning option

For details on the settings, refer to the following.

☞ Page 481 [Cd.40] ABS direction in degrees

■Buffer memory address

For the buffer memory address of this area, refer to the following.

☞ Page 552 Positioning data

■Default value

The default value is 0: Use the setting value in [Cd.40] ABS direction in degrees for all the axes.

[Da.29] Interpolation speed specification method

Set the interpolation speed specification method for each positioning data.

Interpolation speed specification method	Setting value
Use the setting value in [Pr.20] Interpolation speed specification method	0
Composite speed	1
Reference axis speed	2

For the setting, refer to the following and check the assignment of this area.

☞ Page 432 Configuration of positioning option

For details on the settings, refer to the following.

☞ Page 401 [Pr.20] Interpolation speed specification method

■Buffer memory address

For the buffer memory address of this area, refer to the following.

☞ Page 552 Positioning data

■Default value

The default value is 0: Use the setting value in [Pr.20] Interpolation speed specification method for all the axes.

17.5 Block Start Data

The following figure shows the configuration of the block start data stored in the buffer memory of the positioning module.

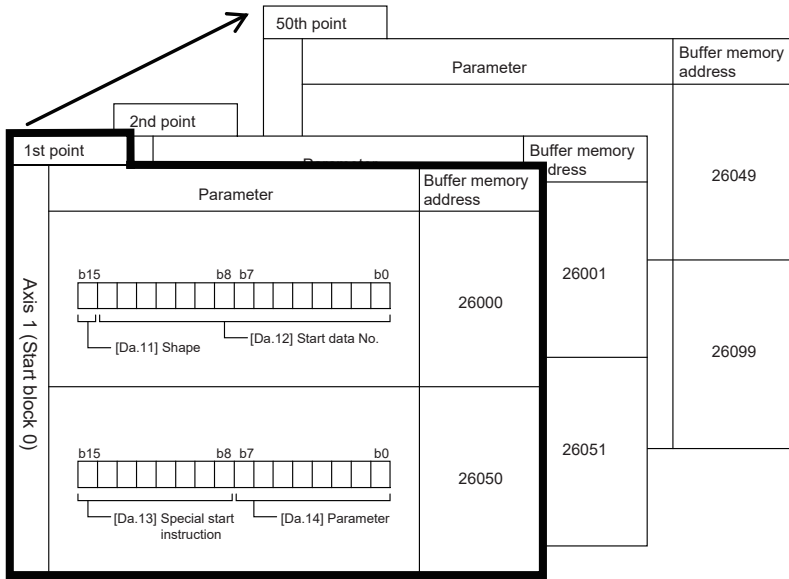

- Up to 50 points of block start data can be configured (stored) via buffer memory addresses as illustrated in the left figure.
- Each block data registration is configured with multiple parameters in a start block number as illustrated by the thick black line.
- Up to five blocks are available per axis. These five blocks are labeled as start blocks 0 through 4.

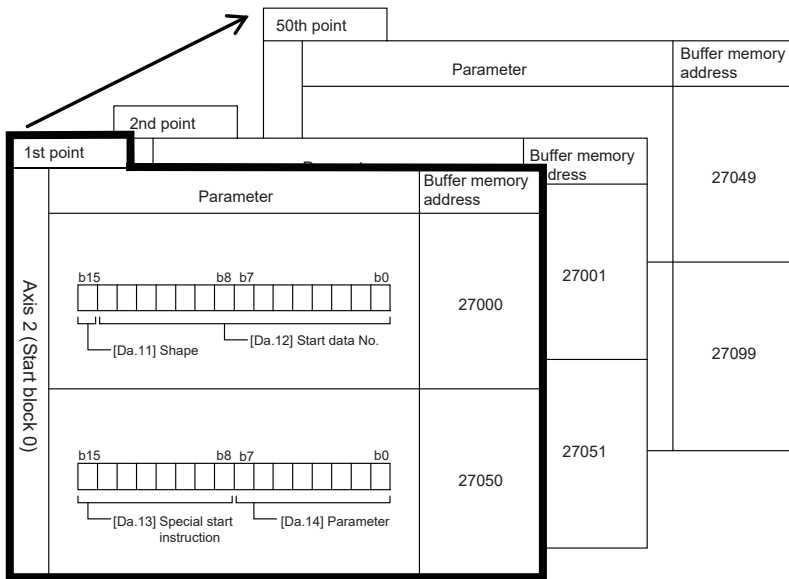

To perform an advanced positioning control using Block start data, set a number between 7000 and 7004 for [Cd.3] Positioning start No. and use [Cd.4] Positioning starting point No. to specify a point number between 1 and 50, a position counted from the beginning of the block.

The numbers between 7000 and 7004 are called Block No.

With the positioning module, up to 50 points of Block start data and up to 10 items of Condition data can be assigned to each Block No.

Block No. *1	Axis	Block start data	Condition	Buffer memory	GX Works3
7000	Axis 1	Start block 0	Condition data (1 to 10)	Setting possible	Setting possible
	Axis 2		Condition data (1 to 10)		
7001	Axis 1	Start block 1	Condition data (1 to 10)		
	Axis 2		Condition data (1 to 10)		
7002	Axis 1	Start block 2	Condition data (1 to 10)		
	Axis 2		Condition data (1 to 10)		
7003	Axis 1	Start block 3	Condition data (1 to 10)		
	Axis 2		Condition data (1 to 10)		
7004	Axis 1	Start block 4	Condition data (1 to 10)		
	Axis 2		Condition data (1 to 10)		

*1 The numbers cannot be set when Pre-reading start function is used. If any number between 7000 and 7004 is set and the pre-reading start function is performed, Outside start No. range (Error code: 19A3H) occurs.

[Da.11] Shape

Set whether to end the control after only Block start data is executed, or continue executing Block start data set in the next point.

Shape	Setting value	Description
End	0	Executes Block start data of the specified point and completes the control.
Continue	1	Executes Block start data of the specified point and completes the control, then executes Block start data of the next point.

The setting value for this area is stored in the same buffer memory address as that of [Da.12] Start data No. Set this area according to the buffer memory configuration.

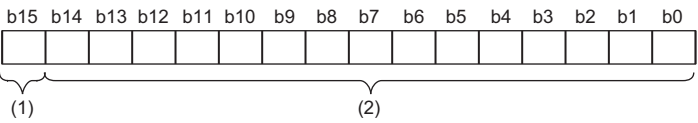
Buffer memory configuration	Assignment
	(1) [Da.11] Shape (2) [Da.12] Start data No.

■Buffer memory address

For the buffer memory address of this area, refer to the following.

☞ Page 552 Positioning data

■Default value

The default value is 0: End for all the axes.

[Da.12] Start data No.

Set Positioning data No. specified with Block start data.

For the setting, refer to the following and check the assignment of this area.

☞ Page 435 [Da.11] Shape

■Buffer memory address

For the buffer memory address of this area, refer to the following.

☞ Page 554 Block start data

■Setting range

The setting range is 1 to 600 (01H to 258H).

■Default value

The default value is 0 for all the axes.

[Da.13] Special start instruction

Set Special start instruction for performing Advanced positioning control. (Set the method by which the positioning data set in [Da.12] Start data No. will be started.)

Special start instruction	Setting value	Description
Block start	0H	With one start, executes positioning data in a block in the set order.
Condition start	1H	Performs the condition judgment specified in Condition data for the specified positioning data. If the conditions have been established, Block start data is executed. If the conditions have not been established, that Block start data is ignored, and Block start data of the next point will be executed.
Wait start	2H	Performs the condition judgment specified in Condition data for the specified positioning data. If the conditions have been established, Block start data is executed. If the conditions have not been established, the control stops (waits) until the conditions are established.
Simultaneous start	3H	Simultaneously executes the positioning data having the number for the axis specified with Condition data (Outputs pulses at the same timing). Up to two axes can start simultaneously.
Repeated start (FOR loop)	4H	Repeats the program from the block start data set with FOR loop to the block start data set in NEXT for the specified number of times.
Repeated start (FOR condition)	5H	Repeats the program from the block start data set with FOR condition to the block start data set in NEXT until the conditions set in Condition data are established.
NEXT start	6H	Set the end of the repetition when 04H: Repeated start (FOR loop) or 05H: Repetition start (FOR condition) is set.

The setting value for this area is stored in the same buffer memory address as that of [Da.14] Parameter. Set this area according to the buffer memory configuration.

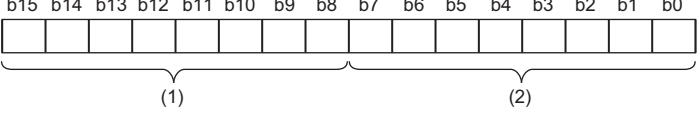
Buffer memory configuration	Assignment	
b15 b14 b13 b12 b11 b10 b9 b8 b7 b6 b5 b4 b3 b2 b1 b0 	(1)	[Da.13] Special start instruction
	(2)	[Da.14] Parameter

For details on the control, refer to the following.

☞ Page 174 ADVANCED POSITIONING CONTROL

■Buffer memory address

For the buffer memory address of this area, refer to the following.



☞ Page 552 Positioning data

■Default value

The default value is 0: Block start for all the axes.

[Da.14] Parameter

Set a value according to the value set in [Da.13] Special start instruction.

Special start instruction	Description
Block start	Not used. (Setting this item is not required.)
Condition start	Set the condition data No. (number of Condition data which is set to perform condition judgment). (For more on condition data, refer to  Page 438 Condition Data)
Wait start	
Simultaneous start	
Repeated start (FOR loop)	Set the number of repetitions.
Repeated start (FOR condition)	Set the condition data No. (number of Condition data which is set to perform condition judgment). (For more on condition data, refer to  Page 438 Condition Data)

For the setting, refer to the following and check the assignment of this area.

 Page 436 [Da.13] Special start instruction

■Buffer memory address

For the buffer memory address of this area, refer to the following.

 Page 554 Block start data

■Setting range

The setting range depends on the setting of [Da.13] Special start instruction.

Setting of [Da.2] Control method	Setting value	Setting detail
Condition start	1 to 10	Condition data No.
Wait start		
Simultaneous start		
Repeated start (FOR condition)		
Repeated start (FOR loop)	0 to 255 (00H to FFH)	Number of repetitions

■Default value

The default value is 0 for all the axes.

17.6 Condition Data

The following figure shows the configuration of the condition data stored in the buffer memory of the positioning module.

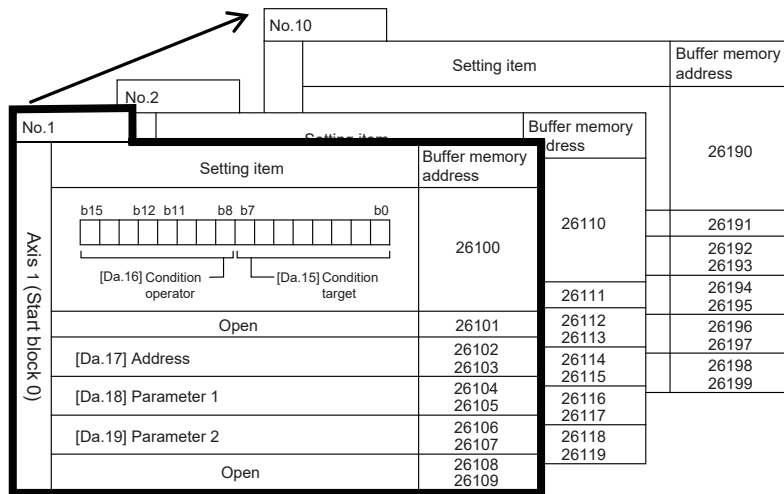

- Up to 10 condition data registration per block number can be configured (stored) via buffer memory addresses as illustrated in the left figure.
- Each condition data registration is configured with multiple parameters in a single block number as illustrated by .
- Up to five blocks are available per axis. These five blocks are labeled as start blocks 0 through 4.

Axis 2 has the same configuration.

[Da.15] Condition target

Set the condition target according to each control.

Condition target	Setting value	Description
Monitor Data ([Md.31]b12 to 15, [Md.140], [Md.141])	01H	Set the state (ON or OFF) of the I/O signals of the positioning module as a condition.
Control Data ([Cd.180], [Cd.181], [Cd.182], [Cd.183], [Cd.184], [Cd.190])	02H	
Buffer memory (1 word)	03H	Set the value stored in the buffer memory as a condition. • Set 03H when the target buffer memory is 1 word (16 bits). • Set 04H when the target buffer memory is 2 words (32 bits).
Buffer memory (2 word)	04H	
Positioning data No.	05H	Select this item only for Simultaneous start.

The setting value for this area is stored in the same buffer memory address as that of [Da.16] Condition operator. Set this area according to the buffer memory configuration.

Buffer memory configuration	Assignment																																																				
<table border="1" style="width: 100%; text-align: center;"> <tr> <td>b15</td><td>b14</td><td>b13</td><td>b12</td><td>b11</td><td>b10</td><td>b9</td><td>b8</td><td>b7</td><td>b6</td><td>b5</td><td>b4</td><td>b3</td><td>b2</td><td>b1</td><td>b0</td> </tr> <tr> <td style="border: 1px solid black;"> </td><td style="border: 1px solid black;"> </td><td style="border: 1px solid black;"> </td><td style="border: 1px solid black;"> </td><td style="border: 1px solid black;"> </td><td style="border: 1px solid black;"> </td><td style="border: 1px solid black;"> </td><td style="border: 1px solid black;"> </td><td style="border: 1px solid black;"> </td><td style="border: 1px solid black;"> </td><td style="border: 1px solid black;"> </td><td style="border: 1px solid black;"> </td><td style="border: 1px solid black;"> </td><td style="border: 1px solid black;"> </td><td style="border: 1px solid black;"> </td><td style="border: 1px solid black;"> </td> </tr> <tr> <td colspan="8" style="text-align: center;">(1)</td> <td colspan="8" style="text-align: center;">(2)</td> </tr> </table>	b15	b14	b13	b12	b11	b10	b9	b8	b7	b6	b5	b4	b3	b2	b1	b0																	(1)								(2)								<table border="1" style="width: 100%;"> <tr> <td>(1)</td> <td>[Da.16] Condition operator</td> </tr> <tr> <td>(2)</td> <td>[Da.15] Condition target</td> </tr> </table>	(1)	[Da.16] Condition operator	(2)	[Da.15] Condition target
b15	b14	b13	b12	b11	b10	b9	b8	b7	b6	b5	b4	b3	b2	b1	b0																																						
(1)								(2)																																													
(1)	[Da.16] Condition operator																																																				
(2)	[Da.15] Condition target																																																				

■ Buffer memory address

For the buffer memory address of this area, refer to the following.

☞ Page 556 Condition data

■ Default value

The default value is 0 for all the axes.

[Da.16] Condition operator

Set the condition operator according to the value set in [Da.15] Condition target.

Setting of [Da.15] Condition target	Condition Operator	Setting value	Description
01H: Axis monitor data	SIG=ON	07H	When the state (ON or OFF) of I/O signals is set as a condition, select ON or OFF as the trigger.
02H: Control Data	SIG=OFF	08H	
03H: Buffer memory (1 word)	**=P1	01H	Set how to use the value (**) stored in the buffer memory. \leq , and \geq are determined by the sign value.
04H: Buffer memory (2 word)	**≠P1	02H	
	**≤P1	03H	
	**≥P1	04H	
	P1≤**≤P2	05H	
	≤P1, P2≤	06H	
05H: Positioning data No.	Axis 1 specification	10H	When Simultaneous start is specified, select the axis (or axes) that start(s) simultaneously.
	Axis 2 specification	20H	

For the setting, refer to the following and check the assignment of this area.

☞ Page 438 [Da.15] Condition target

■Buffer memory address

For the buffer memory address of this area, refer to the following.

☞ Page 556 Condition data

■Default value

The default value is 0 for all the axes.

[Da.17] Address

Set the address according to the value set in [Da.15] Condition target.

Setting of [Da.15] Condition target	Setting value	Description
01H: Axis monitor data	—	Not used. (Setting this item is not required.)
02H: Control Data		
03H: Buffer memory (1 word)	Numerical value (buffer memory address)	Specify the target Buffer memory address. (For the buffer memory of 2 words, set the low-order buffer memory address.)
04H: Buffer memory (2 word)		
05H: Positioning data No.	—	Not used. (Setting this item is not required.)

■Buffer memory address

For the buffer memory address of this area, refer to the following.

☞ Page 556 Condition data

■Default value

The default value is 0 for all the axes.

[Da.18] Parameter 1

Set the parameters according to the value set in [Da.16] Condition operator.

Setting of [Da.16] Condition operator	Setting value	Description
01H: **=P1 02H: **≠P1 03H: **≤P1 04H: **≥P1 05H: P1≤**P2 06H: **≤P1, P2≤**	Numerical value	Set the value of P1 to be equal to or smaller than the value of P2 ($P1 \leq P2$). If P1 is greater than P2 ($P1 > P2$), Condition data error (Error code: 1A04H) occurs.
07H: SIG=ON 08H: SIG=OFF	Numerical value (bit number)	Set the bit number for each signal. ■Monitor Data 00H: READY 01H: Module access flag 04H: Axis 1 M code ON 05H: Axis 2 M code ON 08H: Axis 1 error detection 09H: Axis 2 error detection 0CH: Axis 1 BUSY 0DH: Axis 2 BUSY 10H: Axis 1 start complete 11H: Axis 2 start complete 14H: Axis 1 positioning complete 15H: Axis 2 positioning complete ■Control Data 00H: PLC READY 04H: Axis 1 stop 05H: Axis 2 stop 08H: Axis 1 forward run JOG 09H: Axis 1 reverse run JOG 0AH: Axis 2 forward run JOG 0BH: Axis 2 reverse run JOG 10H: Axis 1 positioning start 11H: Axis 2 positioning start 14H: Axis 1 execution prohibition flag 15H: Axis 2 execution prohibition flag
10H: Axis 1 specification 20H: Axis 2 specification	Numerical value (Positioning data No.)	Set the positioning data number for starting the axis 1 and/or axis 2. <ul style="list-style-type: none"> • Lower 16 bits: Axis 1 positioning data No. 1 to 600 (01H to 258H) • Upper 16 bits: Axis 2 positioning data No. 1 to 600 (01H to 258H)

■Buffer memory address

For the buffer memory address of this area, refer to the following.

☞ Page 556 Condition data

■Default value

The default value is 0 for all the axes.

[Da.19] Parameter 2

Set the parameters according to the value set in [Da.16] Condition operator.

Setting of [Da.16] Condition operator	Setting value	Description
01H: **=P1	—	Not used. (Setting this item is not required.)
02H: **≠P1		
03H: **≤P1		
04H: **≥P1		
05H: $P1 \leq P2$	Numerical value (bit number)	Set the value of P2 to be equal to or greater than the value of P1 ($P1 \leq P2$). If P1 is greater than P2 ($P1 > P2$), Condition data error (Error code: 1A04H) occurs.
06H: $** \leq P1, P2 \leq **$		
07H: DEV=ON	—	Not used. (Setting this item is not required.)
08H: DEV=OFF		
10H: Axis 1 specification		
20H: Axis 2 specification	—	

■ Buffer memory address

For the buffer memory address of this area, refer to the following.

 Page 556 Condition data

■ Default value

The default value is 0 for all the axes.

17.7 Monitor Data

System monitor data

[Md.1] In test mode flag

This area stores information indicating whether or not the GX Works3 test mode is in use.

In test mode flag	Stored value
Not in test mode	0
In test mode	1

■Buffer memory address

The following table shows the buffer memory address of this area.

Buffer memory name	Common for axes 1 and 2
[Md.1] In test mode flag	1200

[Md.130] Firmware version

This area stores the firmware version of the positioning module. Monitor the value in decimal format.

The refresh cycle is each time the power is turned on.

Ex.

Firmware version of the positioning module is Ver. 1.000

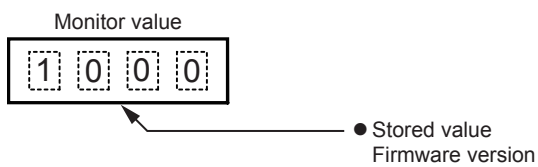

■Buffer memory address

The following table shows the buffer memory address of this area.

Buffer memory name	Common for axes 1 and 2
[Md.130] Firmware version	1206, 1207

[Md.3] Start information

This area stores the start information (restart flag, start origin, and starting axis).

- Restart flag: Indicates whether the operation has been temporarily stopped and restarted.
- Start source: Indicates the source of the start signal.
- Starting axis: Indicates the started axis

The following figure shows the information to be stored.

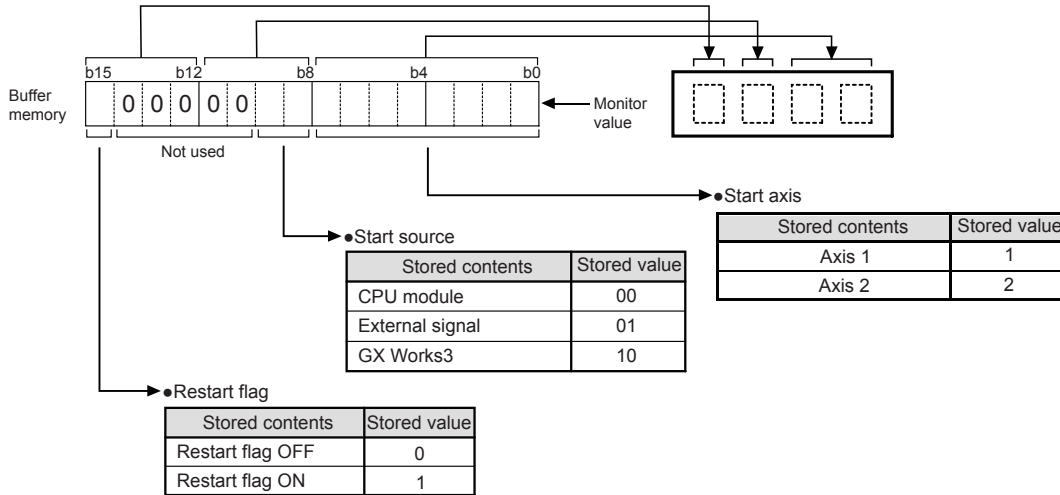

■ Buffer memory address

For the buffer memory address of this area, refer to the following.

☞ Page 369 Monitor Data

■ Configuration of start history

Information on starts is stored in the start history of pointer 0 to 15. The following figure shows the configuration of the start history.

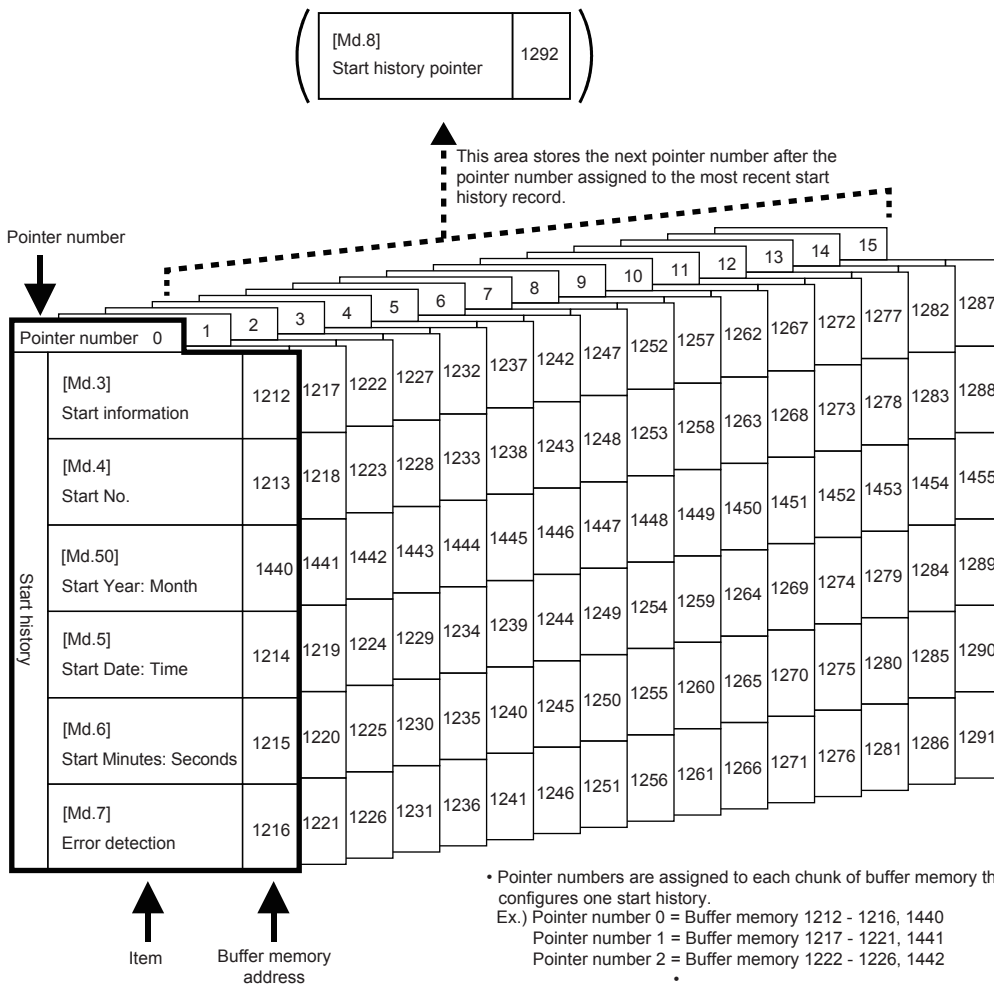

▲ This area stores the next pointer number after the pointer number assigned to the most recent start history record.

- Pointer numbers are assigned to each chunk of buffer memory that configures one start history.
- Ex.) Pointer number 0 = Buffer memory 1212 - 1216, 1440
- Pointer number 1 = Buffer memory 1217 - 1221, 1441
- Pointer number 2 = Buffer memory 1222 - 1226, 1442
- ⋮
- Pointer number 15 = Buffer memory 1287 - 1291, 1455
- History records are stored using pointer numbers labeled "0 -15". The sequence repeats once the maximum number of history records is reached, and so the 17th history is stored using pointer number "0". The old history record is overwritten by the new record.

When the number of the start history exceeds 15, the newer start information is stored from pointer 0 again and the previous start information is overwritten.

[Md.4] Start No.

This area stores the start number.

Start No.	Stored value
Positioning operation	<ul style="list-style-type: none"> • 1 to 600(1H to 258H) • 7000(1B58H) • 7001(1B59H) • 7002(1B5AH) • 7003(1B5BH) • 7004(1B5CH)
JOG operation	9010(2332H)
Manual pulse generator operation	9011(2333H)
Machine OPR	9001(2329H)
Fast OPR	9002(232AH)
Current value change	9003(232BH)
Simultaneous start	9004(232CH)

■Buffer memory address

For the buffer memory address of this area, refer to the following.

☞ Page 369 Monitor Data

[Md.50] Start (year/month)

The start time (year/month) is stored with the BCD code. Monitor the value in hexadecimal format.

Buffer memory configuration	Stored contents	Stored value
	(1) Year (tens place)	0 to 9
	(2) Year (ones place)	0 to 9
	(3) Month (tens place)	0, 1
	(4) Month (ones place)	0 to 9

■Buffer memory address

For the buffer memory address of this area, refer to the following.

☞ Page 369 Monitor Data

[Md.5] Start (date/hour)

The start time (date/hour) is stored with the BCD code. Monitor the value in hexadecimal format.

Buffer memory configuration	Stored contents	Stored value
	(1) Day (tens place)	0 to 3
	(2) Day (ones place)	0 to 9
	(3) Hour (tens place)	0 to 2
	(4) Hour (ones place)	0 to 9

■Buffer memory address

For the buffer memory address of this area, refer to the following.

☞ Page 369 Monitor Data

[Md.6] Start (minute/second)

The start time (minute/second) is stored with the BCD code. Monitor the value in hexadecimal format.

Buffer memory configuration	Stored contents	Stored value
	(1) Minute (tens place)	0 to 5
	(2) Minute (ones place)	0 to 9
	(3) Second (tens place)	0 to 5
	(4) Second (ones place)	0 to 9

■Buffer memory address

For the buffer memory address of this area, refer to the following.

☞ Page 369 Monitor Data

[Md.7] Error judgment

This area stores the result of the error judgment performed on the start.

- BUSY start warning flag
- Error flag
- Error No.

The result of the error judgment is stored as follows.

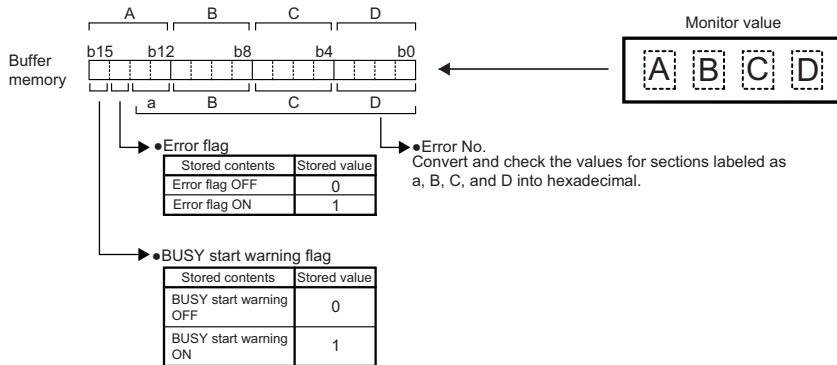

■Buffer memory address

For the buffer memory address of this area, refer to the following.

☞ Page 369 Monitor Data

[Md.8] Start history pointer

This area stores a pointer number that comes next to the pointer number assigned to the latest start history record.

■Buffer memory address

The following table shows the buffer memory address of this area.

Buffer memory name	Common for axes 1 and 2
[Md.8] Start history pointer	1292

[Md.9] Axis in which the error occurred

This area stores the axis number in which the error is detected.

Axis in which the error occurred	Stored value
Axis 1	1
Axis 2	2

■ Buffer memory address

For the buffer memory address of this area, refer to the following.

☞ Page 369 Monitor Data

■ Configuration of error history

Information on errors is stored in the error history of pointer 0 to 15. The following figure shows the configuration of the error history.

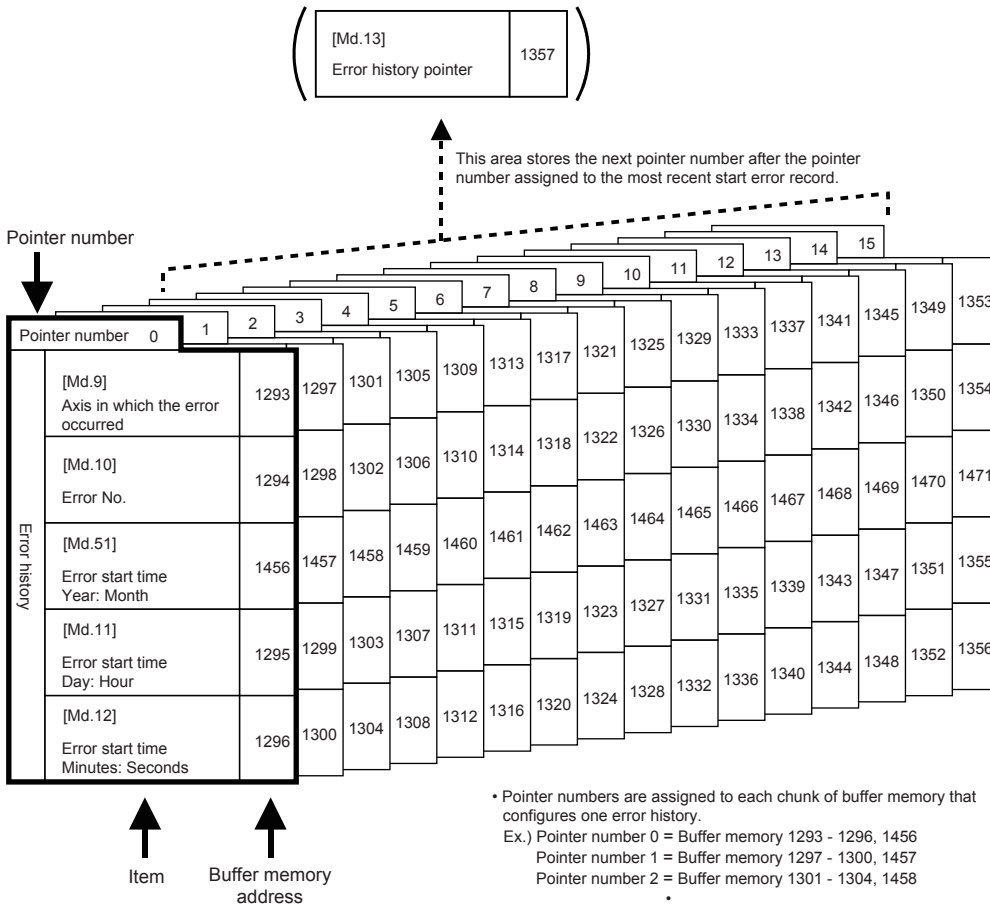

- Pointer numbers are assigned to each chunk of buffer memory that configures one error history.
 Ex.) Pointer number 0 = Buffer memory 1293 - 1296, 1456
 Pointer number 1 = Buffer memory 1297 - 1300, 1457
 Pointer number 2 = Buffer memory 1301 - 1304, 1458
 ⋮
 Pointer number 15 = Buffer memory 1353 - 1356, 1471
- History records are stored using pointer numbers labeled "0 -15". The sequence repeats once the maximum number of history records is reached, and so the 17th history is stored using pointer number "0". The old history record is overwritten by the new record.

When the number of the error history exceeds 15, the newer error information is stored from pointer 0 again and the previous error information is overwritten.

[Md.10] Error No.

This area stores the error number. Monitor the value in hexadecimal.

■ Buffer memory address

For the buffer memory address of this area, refer to the following.

☞ Page 369 Monitor Data

[Md.51] Error occurrence (year/month)

This area stores the time (year/month) when an error occurs with the BCD code. Monitor the value in hexadecimal format.

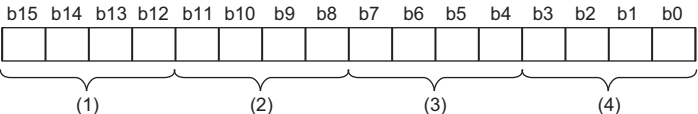
Buffer memory configuration	Stored contents	Stored value
	(1) Year (tens place)	0 to 9
	(2) Year (ones place)	0 to 9
	(3) Month (tens place)	0, 1
	(4) Month (ones place)	0 to 9

■Buffer memory address

For the buffer memory address of this area, refer to the following.

☞ Page 369 Monitor Data

[Md.11] Error occurrence (date/hour)

This area stores the time (date/hour) when an error occurs with the BCD code. Monitor the value in hexadecimal format.

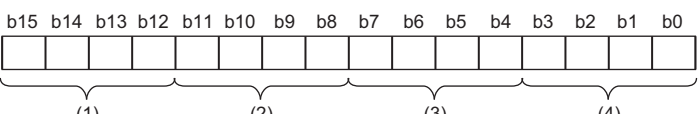
Buffer memory configuration	Stored contents	Stored value
	(1) Day (tens place)	0 to 3
	(2) Day (ones place)	0 to 9
	(3) Hour (tens place)	0 to 2
	(4) Hour (ones place)	0 to 9

■Buffer memory address

For the buffer memory address of this area, refer to the following.

☞ Page 369 Monitor Data

[Md.12] Error occurrence (minute/second)

This area stores the time (minute/second) when an error occurs with the BCD code. Monitor the value in hexadecimal format.

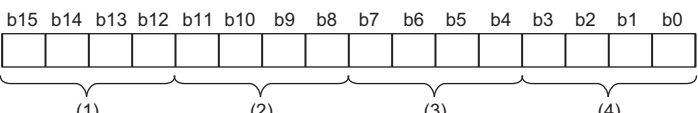
Buffer memory configuration	Stored contents	Stored value
	(1) Minute (tens place)	0 to 5
	(2) Minute (ones place)	0 to 9
	(3) Second (tens place)	0 to 5
	(4) Second (ones place)	0 to 9

■Buffer memory address

For the buffer memory address of this area, refer to the following.

☞ Page 369 Monitor Data

[Md.13] Error history pointer

This area stores a pointer number that comes next to the number assigned to the latest error history record.

■Buffer memory address

The following table shows the buffer memory address of this area.

Buffer memory name	Common for axes 1 and 2
[Md.13] Error history pointer	1357

[Md.14] Axis in which the warning occurred

This area stores the axis number in which the warning is detected.

Axis in which the warning occurred	Stored value
Axis 1	1
Axis 2	2

■ Buffer memory address

For the buffer memory address of this area, refer to the following.

☞ Page 369 Monitor Data

■ Warning history configuration

Information on warnings is stored in the warning history of pointer 0 to 15. The following figure shows the configuration of the warning history.

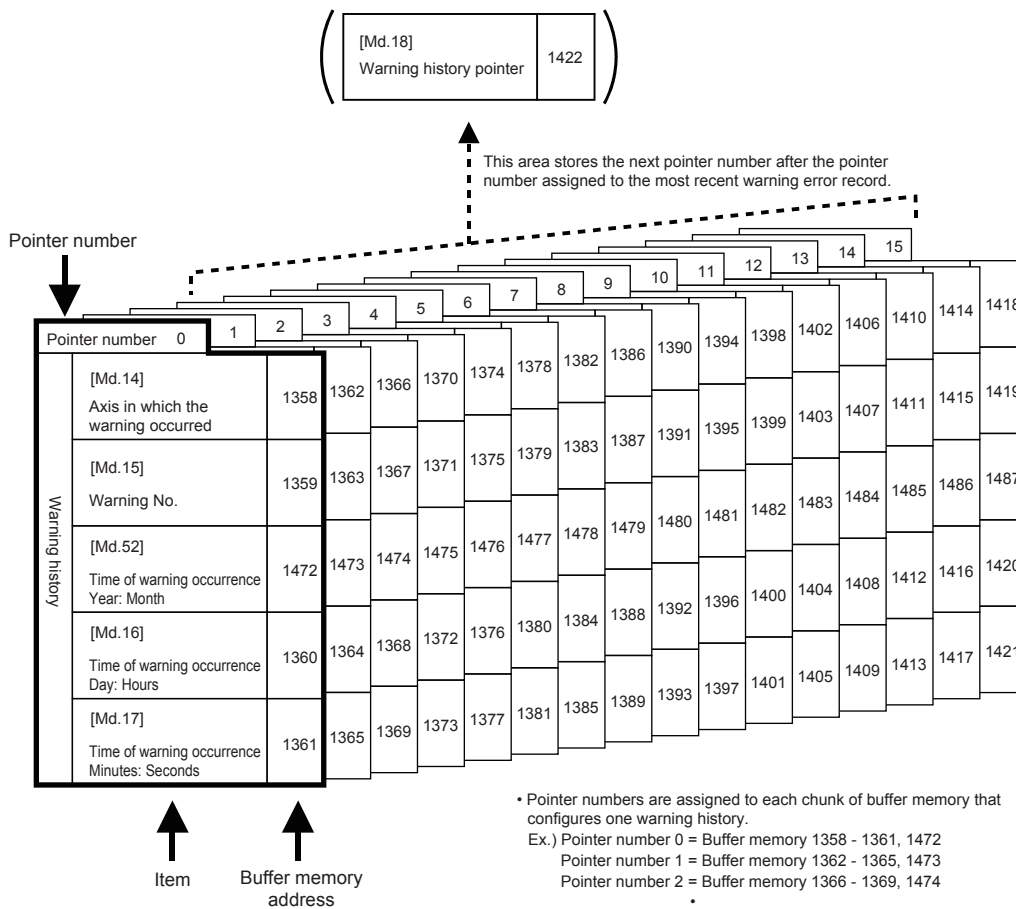

- Pointer numbers are assigned to each chunk of buffer memory that configures one warning history.
 Ex.) Pointer number 0 = Buffer memory 1358 - 1361, 1472
 Pointer number 1 = Buffer memory 1362 - 1365, 1473
 Pointer number 2 = Buffer memory 1366 - 1369, 1474
 ⋮
 Pointer number 15 = Buffer memory 1418 - 1421, 1487
- History records are stored using pointer numbers labeled "0 -15".
 The sequence repeats once the maximum number of history records is reached, and so the 17th history is stored using pointer number "0".
 The old history record is overwritten by the new record.

When the number of the warning history exceeds 15, the newer warning information is stored from pointer 0 again and the previous warning information is overwritten.

[Md.15] Warning No.

This area stores the warning No. Monitor the value in hexadecimal.

■ Buffer memory address

For the buffer memory address of this area, refer to the following.

☞ Page 369 Monitor Data

[Md.52] Warning occurrence (year/month)

This area stores the time (year/month) when a warning occurs with the BCD code. Monitor the value in hexadecimal format.

Buffer memory configuration	Stored contents	Stored value
	(1) Year (tens place)	0 to 9
	(2) Year (ones place)	0 to 9
	(3) Month (tens place)	0, 1
	(4) Month (ones place)	0 to 9

■Buffer memory address

For the buffer memory address of this area, refer to the following.

☞ Page 369 Monitor Data

[Md.16] Warning occurrence (date/hour)

This area stores the time (date/hour) when a warning occurs with the BCD code. Monitor the value in hexadecimal format.

Buffer memory configuration	Stored contents	Stored value
	(1) Day (tens place)	0 to 3
	(2) Day (ones place)	0 to 9
	(3) Hour (tens place)	0 to 2
	(4) Hour (ones place)	0 to 9

■Buffer memory address

For the buffer memory address of this area, refer to the following.

☞ Page 369 Monitor Data

[Md.17] Warning occurrence (minute/second)

This area stores the time (minute/second) when a warning occurs with the BCD code. Monitor the value in hexadecimal format.

Buffer memory configuration	Stored contents	Stored value
	(1) Minute (tens place)	0 to 5
	(2) Minute (ones place)	0 to 9
	(3) Second (tens place)	0 to 5
	(4) Second (ones place)	0 to 9

■Buffer memory address

For the buffer memory address of this area, refer to the following.

☞ Page 369 Monitor Data

[Md.18] Warning history pointer

This area stores a pointer number that comes next to the pointer number assigned to the latest warning history record.

■Buffer memory address

The following table shows the buffer memory address of this area.

Buffer memory name	Common for axes 1 and 2
[Md.18] Warning history pointer	1422

[Md.19] No. of write accesses to flash ROM

This area stores the number of module data backups and module data initializations performed with a program after the power-on.

The count is cleared to 0 when Flash ROM write number error (Error code: 1080H) and the error is reset.

■ Buffer memory address

The following table shows the buffer memory address of this area.

Buffer memory name	Common for axes 1 and 2
[Md.19] No. of write accesses to flash ROM	1424
	1425

[Md.53] Date of write accesses to flash ROM (year/month)

This area stores the latest date (year/month) when the data is written to flash ROM with the BCD code. Monitor the value in hexadecimal format.

Buffer memory configuration	Stored contents	Stored value
b15 b14 b13 b12 b11 b10 b9 b8 b7 b6 b5 b4 b3 b2 b1 b0 	(1) Year (tens place)	0 to 9
	(2) Year (ones place)	0 to 9
	(3) Month (tens place)	0, 1
	(4) Month (ones place)	0 to 9

■ Buffer memory address

The following table shows the buffer memory address of this area.

Buffer memory name	Common for axes 1 and 2
[Md.53] Date of write accesses to flash ROM (year/month)	1488

[Md.54] Date of write accesses to flash ROM (date/hour)

This area stores the latest date (date/hour) when the data is written to flash ROM with the BCD code. Monitor the value in hexadecimal format.

Buffer memory configuration	Stored contents	Stored value
b15 b14 b13 b12 b11 b10 b9 b8 b7 b6 b5 b4 b3 b2 b1 b0 	(1) Day (tens place)	0 to 3
	(2) Day (ones place)	0 to 9
	(3) Hour (tens place)	0 to 2
	(4) Hour (ones place)	0 to 9

■ Buffer memory address

The following table shows the buffer memory address of this area.

Buffer memory name	Common for axes 1 and 2
[Md.54] Date of write accesses to flash ROM (date/hour)	1489

[Md.55] Date of write accesses to flash ROM (minute/second)

This area stores the latest date (minute/second) when the data is written to flash ROM with the BCD code. Monitor the value in hexadecimal format.

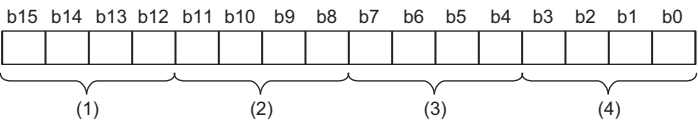
Buffer memory configuration	Stored contents	Stored value
	(1) Minute (tens place)	0 to 5
	(2) Minute (ones place)	0 to 9
	(3) Second (tens place)	0 to 5
	(4) Second (ones place)	0 to 9

■Buffer memory address

The following table shows the buffer memory address of this area.

Buffer memory name	Common for axes 1 and 2
[Md.55] Date of write accesses to flash ROM (minute/second)	1490

[Md.56] Date of write accesses to flash ROM (ms)

This area stores the latest date (ms) when the data is written to flash ROM with the BCD code. Monitor the value in hexadecimal format.

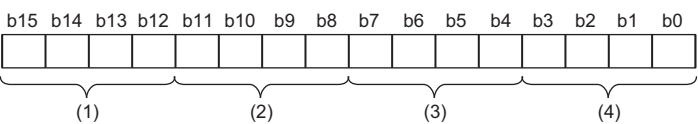
Buffer memory configuration	Stored contents	Stored value
	(1) Use prohibited	Fixed to 0
	(2) ms (hundreds place)	0 to 9
	(3) ms (tens place)	0 to 9
	(4) ms (ones place)	0 to 9

■Buffer memory address

The following table shows the buffer memory address of this area.

Buffer memory name	Common for axes 1 and 2
[Md.56] Date of write accesses to flash ROM (ms)	1491

[Md.59] Module information

The module-specific code is stored with the BCD code. Monitor the value in hexadecimal format.

The refresh cycle is each time the power is turned on.

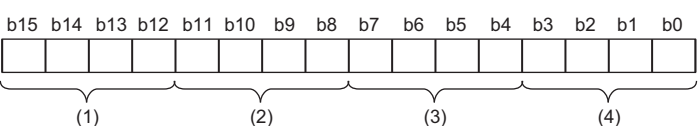
Buffer memory configuration	Stored contents	Stored value
	(1) Fourth digit	0 to F
	(2) Third digit	0 to F
	(3) Second digit	0 to F
	(4) First digit	0 to F

The values to be stored in each model are as follow.

- FX5-20PG-P: 63E2H
- FX5-20PG-D: 63E3H

■Buffer memory address

The following table shows the buffer memory address of this area.

Buffer memory name	Common for axes 1 and 2
[Md.59] Module information	31332

[Md.140] Module status

This area stores the on/off state of various flags. Monitor the value in hexadecimal format.

Buffer memory configuration	Stored contents		Stored value
b15 b14 b13 b12 b11 b10 b9 b8 b7 b6 b5 b4 b3 b2 b1 b0 0 0 0 0 0 0 0 0 0 0 0 0 0 0 0	b0	READY	0, 1
	b1	Module access flag	0, 1
	b2 to b15	Use prohibited	Fixed to 0

■READY ([Md.140] Module status: b0)

- 0: Not READY/Watchdog timer error
- 1: READY

When [Cd.190] PLC READY signal is turned off and on, the parameter setting range is checked. If no error is found, this signal turns on. This signal turns off if the [Cd.190] PLC READY signal turns off or a watchdog error occurs.

Used this signal for program interlocks and similar.

■Module access flag ([Md.140] Module status: b1)

- 0: Module access disabled
- 1: Module access enabled

After the CPU module is set to RUN, this signal turns on with the status that allows the access from the CPU module to the positioning module. This signal turns off while the CPU module is in the STOP status. To access the buffer memory or when turning on [Cd.190] PLC READY signal, the interlock must be provided so that the desired operation occurs after Module access flag ([Md.140] Module status: b1) turns on.

■Buffer memory address

The following table shows the buffer memory address of this area.

Buffer memory name	Common for axes 1 and 2
[Md.140] Module status	31500

[Md.141] BUSY signal

This area stores the on/off state of the BUSY signal. Monitor the value in hexadecimal format.

Buffer memory configuration	Stored contents		Stored value
b15 b14 b13 b12 b11 b10 b9 b8 b7 b6 b5 b4 b3 b2 b1 b0 0 0 0 0 0 0 0 0 0 0 0 0 0 0 0	b0	Axis 1 BUSY	0, 1
	b1	Axis 2 BUSY	0, 1
	b2 to b15	Use prohibited	Fixed to 0

■Axis 1 BUSY signal ([Md.141] BUSY signal: b0), Axis 2 BUSY signal ([Md.141] BUSY: b1)

- 0: OFF (Not BUSY)
- 1: ON (BUSY)

This signal turns on at the start of the positioning, OPR, or JOG operation. During manual pulse generator operation, this signal turns on while [Cd.21] Manual pulse generator enable flag is on.

This signal turns off once the time configured with "[Da.9] Dwell time" elapses after positioning stops. The ON state continues while the positioning operation continues. The signal turns off in the event of an error stop, positioning stop due to stop processing, or stopped due to step operation.

■Buffer memory address

The following table shows the buffer memory address of this area.

Buffer memory name	Common for axes 1 and 2
[Md.141] BUSY signal	31501

Axis monitor data

[Md.20] Current feed value

This area stores the currently commanded address or the address of the current position. The stored value is different from the actual motor position during operation. Multiplying the stored value by the following converted value enables the monitoring of the converted value in each unit.

Unit	Converted value
μm	$\times 10^{-1}$
inch	$\times 10^{-5}$
degree	$\times 10^{-5}$
pulse	$\times 1$

- When the unit is degree, the address is a ring address of values between 0 and 359.99999°.
- The update cycle of this area is 0.88 ms.
- When the machine OPR is completed, the OP address is stored.
- When the current value is changed with the current value change function, the changed value is stored.

■ Buffer memory address

The following table shows the buffer memory address of this area.

Buffer memory name	Axis 1	Axis 2
[Md.20] Current feed value	800	900
	801	901

[Md.21] Machine feed value

This area stores the address of the current position according to the machine coordinate (coordinate specified with the machine). The stored value is different from the actual motor position during operation. Multiplying the stored value by the following converted value enables the monitoring of the converted value in each unit.

Unit	Converted value
μm	$\times 10^{-1}$
inch	$\times 10^{-5}$
degree	$\times 10^{-5}$
pulse	$\times 1$

- The update cycle of this area is 0.88 ms.
- Under the speed control, the machine feed value is constantly updated regardless of the parameter setting.
- The value is not cleared to 0 at the beginning of fixed-feed.

■ Buffer memory address

The following table shows the buffer memory address of this area.

Buffer memory name	Axis 1	Axis 2
[Md.21] Machine feed value	802	902
	803	903

[Md.22] Feedrate

This area stores the command output speed of the operating workpiece. The stored value may be different from the actual motor speed during operation. Multiplying the stored value by the following converted value enables the monitoring of the converted value in each unit.

Unit	Converted value
mm/min	$\times 10^{-2}$
inch/min	$\times 10^{-3}$
degree/min	$\times 10^{-3}$
pulse/s	$\times 1$

- During interpolation operation, the composite speed or reference axis speed is stored for the reference axis. 0 is stored for the interpolation axis.
- The update cycle of this area is 0.88 ms.

■Buffer memory address

The following table shows the buffer memory address of this area.

Buffer memory name	Axis 1	Axis 2
[Md.22] Feedrate	804	904
	805	905

[Md.23] Axis error No.

When an error is detected, this area stores the error code corresponding to the error. Monitor the value in hexadecimal.

- The latest error code is stored at all times and when a new error occurs, the error code is overwritten.
- When [Cd.5] Axis error reset (axis control data) is turned on, the error code is cleared to 0.

■Buffer memory address

The following table shows the buffer memory address of this area.

Buffer memory name	Axis 1	Axis 2
[Md.23] Axis error No.	806	906

[Md.24] Axis warning No.

When a warning is detected, this area stores the warning code corresponding to the warning. Monitor the value in hexadecimal.

- The latest warning code is stored at all times and when a new warning occurs, the warning code is overwritten.
- When [Cd.5] Axis error reset (axis control data) is turned on, the warning code is cleared to 0.

■Buffer memory address

The following table shows the buffer memory address of this area.

Buffer memory name	Axis 1	Axis 2
[Md.24] Axis warning No.	807	907

[Md.25] Valid M code

This area stores the M code that is currently valid (i.e. set to the positioning data relating to the current operation).

- The range of the stored value is 0 to 65535.
- This area is updated when M code ON signal ([Md.31] Status: b12) turns on.
- 0 is stored when the [Cd.190] PLC READY signal turns off.

■Buffer memory address

The following table shows the buffer memory address of this area.

Buffer memory name	Axis 1	Axis 2
[Md.25] Valid M code	808	908

[Md.26] Axis operation status

This area stores the axis operation status. The following table shows the stored values.

Axis operation status	Stored value
Step standby	-2
Error	-1
Standby	0
Stopped	1
Interpolation	2
JOG operation	3
Manual pulse generator operation	4
Analyzing	5
Special start standby	6
OPR	7
Position control	8
Speed control	9
Speed control in speed-position switching control	10
Position control in speed-position switching control	11
Position control in position-speed switching control	12
Speed control in position-speed switching control	13
Start time adjusting	14

■Buffer memory address

The following table shows the buffer memory address of this area.

Buffer memory name	Axis 1	Axis 2
[Md.26] Axis operation status	809	909

[Md.27] Current speed

This area stores the value set in [Da.8] Command speed for the positioning data being executed.

- If [Da.8] Command speed is set to -1, this area stores the value in [Da.8] Command speed which is set by the positioning data used one step earlier.
- If [Da.8] Command speed is set to a value other than -1, this area stores the value in [Da.8] Command speed which is set by the positioning data being executed.
- If the speed change function is executed, the value set in [Cd.14] New speed value is stored.

Multiplying the stored value by the following converted value enables the monitoring of the converted value in each unit.

Unit	Converted value
mm/min	$\times 10^{-2}$
inch/min	$\times 10^{-3}$
degree/min	$\times 10^{-3}$
pulse/s	$\times 1$

■Buffer memory address

The following table shows the buffer memory address of this area.

Buffer memory name	Axis 1	Axis 2
[Md.27] Current speed	810	910
	811	911

[Md.28] Axis feedrate

This area stores the speed which is actually output as a command in each axis at that time. The stored value may be different from the actual motor speed. Multiplying the stored value by the following converted value enables the monitoring of the converted value in each unit.

Unit	Converted value
mm/min	$\times 10^{-2}$
inch/min	$\times 10^{-3}$
degree/min	$\times 10^{-3}$
pulse/s	$\times 1$

- When the axis is at a stop, 0 is stored.
- The update cycle of this area is 0.88 ms.

■ Buffer memory address

The following table shows the buffer memory address of this area.

Buffer memory name	Axis 1	Axis 2
[Md.28] Axis feedrate	812	912
	813	913

[Md.29] Speed-position switching control positioning amount

This area stores the movement amount for the position control to end after the control is switched to the position control with the speed-position switching control. Multiplying the stored value by the following converted value enables the monitoring of the converted value in each unit.

Unit	Converted value
μm	$\times 10^{-1}$
inch	$\times 10^{-5}$
degree	$\times 10^{-5}$
pulse	$\times 1$

When [Da.2] Control method is the speed-position switching control (reverse run), a negative value is stored.

■ Buffer memory address

The following table shows the buffer memory address of this area.

Buffer memory name	Axis 1	Axis 2
[Md.29] Speed-position switching control positioning amount	814	914
	815	915

[Md.30] External I/O signal

This area stores the on/off state of external I/O signals.

External I/O signal	Stored value
OFF	0
ON	1

Values are stored in the bits corresponding to each external I/O signal. The following table shows the assignment of each external I/O signal.

Buffer memory	Assignment of I/O signals	
b15 b14 b13 b12 b11 b10 b9 b8 b7 b6 b5 b4 b3 b2 b1 b0	b0	Lower limit signal
0 0 0 0 0 0 0 0 0 0 0 0 0 0 0 0	b1	Upper limit signal
	b2	Drive unit READY signal
	b3	Stop signal
	b4	External command signal
	b5	Zero signal
	b6	Near-point dog signal
	b7	Use prohibited (fixed to 0)
	b8	Deviation counter clear signal
	b9 to b15	Use prohibited (fixed to 0)

The update cycle of this area is 0.88 ms.

■ Buffer memory address

The following table shows the buffer memory address of this area.

Buffer memory name	Axis 1	Axis 2
[Md.30] External I/O signal	816	916

Restriction

If 1: Pre-analysis mode is set for [Cd.43] Analysis mode setting and [Cd.184] Positioning start signal is used as the start trigger, the external command signal (CHG) is disabled from when the positioning data analysis starts until a pulse input starts by inputting the start trigger. Thus, the external command signal ([Md.30] External I/O signal: b4) is fixed to 0 during that time.

[Md.31] Status

This area stores the on/off state of various flags.

Status	Stored value
OFF	0
ON	1

The following shows the flags to be stored.

Flag	Description
In speed control flag	This signal, which turns on during the speed control, is used to judge whether the operation is performed under the speed control or position control. This signal turns off at the power-on, in the position control, and during the JOG operation or manual pulse generator operation. During the speed-position switching control or position-speed switching control, this signal turns on only when the speed control is performed. When the speed control is switched to the position control by the speed-position switching signal, this signal turns off. When the position control is switched to the speed control by the position-speed switching signal, this signal turns on.
Speed-position switching latch flag	This signal is used to interlock the movement amount change function in the speed-position switching control. During the speed-position switching control, this signal turns on when the speed control is switched to the position control. This signal turns off when the next positioning data is processed, and during the JOG operation or manual pulse generator operation.
Command in-position flag	This signal turns on when the remaining distance is equal to or less than the command in-position width (set by a detailed parameter). This signal remains off with the data for which the continuous path control (P11) is specified as the operation pattern. The state of this signal is monitored every 0.88 ms. It is not monitored under the speed control or while the speed control is in effect during the speed-position switching control or position-speed switching control. While operations are performed with interpolation, this signal turns on only for the starting axis. (This signal turns off for all the axes at the start.)

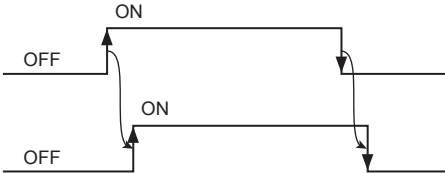
Flag	Description
OPR request flag	This signal turns on when the power is switched on, Drive unit READY signal is turned off, [Cd.190] PLC READY signal is turned on, or a machine OPR starts. This signal turns off when the machine OPR completes.
OPR complete flag	This signal turns on when a machine OPR completes normally. It turns off when the operation starts, Drive unit READY signal is turned off, or [Cd.190] PLC READY signal is turned on.
Position-speed switching latch flag	This signal is used to interlock the command speed change function in the position-speed switching control. During the position-speed switching control, this signal turns on when the position control is switched to the speed control. This signal turns off when the next positioning data is processed, and during the JOG operation or manual pulse generator operation.
Axis warning detection	This signal turns on when an axis warning occurs and turns off when Axis error reset is turned on.
Speed change 0 flag	This signal turns on when a speed change request is issued with the new speed value being 0 and turns off when a speed change request issued with a new speed value other than 0.
M code ON	In the WITH mode, this signal turns on when the positioning data operation is started. In the AFTER mode, this signal turns on when the positioning data operation is completed. This signal turns off with [Cd.7] M code ON signal OFF request. When no M code is specified (When [Da.10] M code is 0), this signal remains off. With using continuous path control for the positioning operation, the positioning continues even when this signal does not turn off. However, M code ON signal ON (Warning code: 0992H) will occur. When [Cd.190] PLC READY signal is turned off, this signal also turns off. If the operation is started while the M code is on, M code ON signal ON start (Error code: 19A0H) will occur.
Error detection	This signal turns on when an error occurs, and turns off when the error is reset via [Cd.5] Axis error reset or [Cd.49] All axes error reset.
Start complete	This signal turns on when the positioning module starts the positioning processing since Positioning start signal is turned on. (Start complete signal also turns on during OPR control.) [Cd.184] Positioning start signal Start complete ([Md.31] Status: b14) 
Positioning complete	This signal turns on for the time set in [Pr.40] Positioning complete signal output time from the instant when the positioning control for each positioning data No. is completed. For the interpolation control, Positioning complete signal of the interpolation axis turns on for the time set to the reference axis. (This signal does not turn on when [Pr.40] Positioning complete signal output time is 0.) This signal will turn off if the positioning (including OPR), JOG operation, inching operation, or manual pulse generator operation is started while this signal is on. This signal will not turn on when the speed control or positioning is canceled midway.

Values are stored in the bits corresponding to each flag. The following table shows the assignment of each external input signal.

Buffer memory	Assignment of flags
b15 b14 b13 b12 b11 b10 b9 b8 b7 b6 b5 b4 b3 b2 b1 b0	b0 In speed control flag
<input type="checkbox"/> <input type="checkbox"/> <input type="checkbox"/> <input type="checkbox"/> <input type="checkbox"/> <input type="checkbox"/> <input type="checkbox"/> <input type="checkbox"/> <input type="checkbox"/> <input type="checkbox"/> <input type="checkbox"/> <input type="checkbox"/> <input type="checkbox"/> <input type="checkbox"/> <input type="checkbox"/> <input type="checkbox"/>	b1 Speed-position switching latch flag
	b2 Command in-position flag
	b3 OPR request flag
	b4 OPR complete flag
	b5 Position-speed switching latch flag
	b6 to b8 Use prohibited (fixed to 0)
	b9 Axis warning detection
	b10 Speed change 0 flag
	b11 Use prohibited (fixed to 0)
	b12 M code ON
	b13 Error detection
	b14 Start complete
	b15 Positioning complete

■Buffer memory address

The following table shows the buffer memory address of this area.

Buffer memory name	Axis 1	Axis 2
[Md.31] Status	817	917

[Md.32] Target value

This area stores the target value ([Da.6] Positioning address/movement amount) for a positioning operation. The stored value depends on the positioning operation as shown below.

Positioning operation	Stored value
When the position control and current value change are started	The value of [Da.6] Positioning address/movement amount is stored.
When the OP shift operation of the OPR control	The value of the OP shift amount is stored.
Other than the above	0 is stored.

Multiplying the stored value by the following converted value enables the monitoring of the converted value in each unit.

Unit	Converted value
μm	$\times 10^{-1}$
inch	$\times 10^{-5}$
degree	$\times 10^{-5}$
pulse	$\times 1$

■ Buffer memory address

The following table shows the buffer memory address of this area.

Buffer memory name	Axis 1	Axis 2
[Md.32] Target value	818	918
	819	919

[Md.33] Target speed

The stored value depends on the positioning operation as shown below.

Positioning operation	Stored value
Operation with positioning data	The actual target speed, considering the override, speed limit value and other factors, is stored. When positioning is completed, 0 is stored.
Interpolation of position control	The composite speed or reference axis speed is stored in this area of the reference axis, and 0 is stored in this area of the interpolation axis.
Interpolation of speed control	The target speeds of the reference axis and interpolation axis are stored in the monitor of each axis.
JOG operation	The actual target speed, considering the JOG speed limit value for the JOG speed, is stored.
Manual pulse generator operation	0 is stored.

Multiplying the stored value by the following converted value enables the monitoring of the converted value in each unit.

Unit	Converted value
mm/min	$\times 10^{-2}$
inch/min	$\times 10^{-3}$
degree/min	$\times 10^{-3}$
pulse/s	$\times 1$

■ Buffer memory address

The following table shows the buffer memory address of this area.

Buffer memory name	Axis 1	Axis 2
[Md.33] Target speed	820	920
	821	921

[Md.63] OPR request flag ON factor

This area stores the cause which turns on OPR request flag ([Md.31] Status: b3).

OPR request flag ON cause	Stored value
No cause	0
Power-on	1
PLC READY is turned off and on	2
Drive unit READY OFF	3
Test mode	4
Machine OPR start	5

■Buffer memory address

The following table shows the buffer memory address of this area.

Buffer memory name	Axis 1	Axis 2
[Md.63] OPR request flag ON factor	822	922

[Md.64] Positioning control complete factor

This area stores the complete factor of OPR control and major positioning control.

Positioning control end cause	Stored value
Operation does not start after power-on or operation is being performed	0
Normal completion (Positioning control is completed correctly)	1
Normal completion (Positioning control is completed by a stop signal)	2
Normal completion (Positioning control is completed by the external stop)	3
Error completion (Positioning control is completed by an error occurrence at start)	4
Error completion (Positioning control is completed by an error occurrence during an operation)	5

■Buffer memory address

The following table shows the buffer memory address of this area.

Buffer memory name	Axis 1	Axis 2
[Md.64] Positioning control complete factor	823	923

[Md.34] Movement amount after near-point dog ON

- This area stores 0 when machine OPR starts.
- After machine OPR starts, the movement amount from the near-point dog ON to the machine OPR completion is stored. The movement amount indicates the amount machine to OPR completion using near-point dog ON as 0. The OP shift amount is excluded.
- For the stopper method 1, 2, or 3, 0 is always stored.

Multiplying the stored value by the following converted value enables the monitoring of the converted value in each unit.

Unit	Converted value
μm	$\times 10^{-1}$
inch	$\times 10^{-5}$
degree	$\times 10^{-5}$
pulse	$\times 1$

■Buffer memory address

The following table shows the buffer memory address of this area.

Buffer memory name	Axis 1	Axis 2
[Md.34] Movement amount after near-point dog ON	824	924
	825	925

[Md.35] Torque limit stored value

This area stores the value set in [Pr.17] Torque limit setting value or [Cd.22] New torque value.

- During positioning start, JOG operation start, manual pulse generator operation (when [Cd.21] Manual pulse generator enable flag is turned on), the value set in [Pr.17] Torque limit setting value is stored.
- When a value other than 0 is set in [Cd.22] New torque value, the value set in [Cd.22] New torque value is stored.
- When the creep speed is reached with the OPR, the value set in [Pr.54] OPR torque limit value is stored.

■Buffer memory address

The following table shows the buffer memory address of this area.

Buffer memory name	Axis 1	Axis 2
[Md.35] Torque limit stored value	826	926

[Md.36] Special start data instruction code setting value

This area stores Instruction code used with special start and indicated by the start data pointer currently being executed.

Special start data instruction code setting value	Stored value
Block start (normal start)	0
Condition start	1
Wait start	2
Simultaneous start	3
FOR loop	4
FOR condition	5
NEXT	6

■Buffer memory address

The following table shows the buffer memory address of this area.

Buffer memory name	Axis 1	Axis 2
[Md.36] Special start data instruction code setting value	827	927

[Md.37] Special start data instruction parameter setting value

This area stores Instruction parameter used with special start and indicated by the start data pointer currently being executed is stored. The stored value depends on the value stored in [Md.36] Special start data instruction code setting value as shown below.

Stored value of [Md.36] Special start data instruction code setting value	Stored contents	Stored value
Block start (normal start), NEXT	None	None
Condition start, wait start, simultaneous start, FOR condition	Condition data No.	1 to 10
FOR loop	Number of repetitions	0 to 255

■Buffer memory address

The following table shows the buffer memory address of this area.

Buffer memory name	Axis 1	Axis 2
[Md.37] Special start data instruction parameter setting value	828	928

[Md.38] Start positioning data No. setting value

This area stores Positioning data No. indicated by the start data pointer currently being executed.

■Buffer memory address

The following table shows the buffer memory address of this area.

Buffer memory name	Axis 1	Axis 2
[Md.38] Start positioning data No. setting value	829	929

[Md.39] In speed limit flag

This area stores whether the operation is performed with the speed limited.

In speed limit flag	Stored value
Not in speed limit (off)	0
In speed limit (on)	1

- If the speed exceeds the value set in [Pr.8] Speed limit value due to a speed change or override, the speed limit functions, and this area turns on.
- When the speed drops to less than the value set in [Pr.8] Speed limit value, or when the axis stops, this area turns off.

■Buffer memory address

The following table shows the buffer memory address of this area.

Buffer memory name	Axis 1	Axis 2
[Md.39] In speed limit flag	830	930

[Md.40] In speed change processing flag

This area stores whether the speed is being changed or not.

In speed limit flag	Stored value
Not in speed change (off)	0
In speed change (on)	1

- When the speed is changed during positioning control, this area turns on.
- After the speed change processing is completed or when deceleration starts with a stop signal during the speed change processing, this area turns off.

■Buffer memory address

The following table shows the buffer memory address of this area.

Buffer memory name	Axis 1	Axis 2
[Md.40] In speed change processing flag	831	931

[Md.41] Special start repetition counter

This area stores the remaining number of repetitions when Repetition is executed with the special start.

- The range of the stored value is 0 to 255.
- The count is decremented by one at the loop end.
- When the count reaches 0, the loop ends
- For an endless loop, 0 is stored.

■Buffer memory address

The following table shows the buffer memory address of this area.

Buffer memory name	Axis 1	Axis 2
[Md.41] Special start repetition counter	832	932

[Md.42] Control method repetition counter

This area stores the remaining number of repetitions when Repetition is executed with the control method.

- The count is decremented by one at the loop start.
- The loop ends with the positioning data of the control method LEND, after the counter reaches 0.

■Buffer memory address

The following table shows the buffer memory address of this area.

Buffer memory name	Axis 1	Axis 2
[Md.42] Control method repetition counter	833	933

[Md.43] Start data pointer being executed

This area stores a point number (1 to 50) of the start data currently being executed. When a positioning operation completes, it stores 0.

■Buffer memory address

The following table shows the buffer memory address of this area.

Buffer memory name	Axis 1	Axis 2
[Md.43] Start data pointer being executed	834	934

[Md.44] Positioning data No. being executed

This area stores the positioning data No. of the positioning data currently being executed. When the JOG operation or inching operation is executed, 0 is stored.

■Buffer memory address

The following table shows the buffer memory address of this area.

Buffer memory name	Axis 1	Axis 2
[Md.44] Positioning data No. being executed	835	935

[Md.45] Block No. being executed

When the operation is controlled by Block start data, this area stores the block No. (7000 to 7004) of the block currently being executed. In other operations, this area stores 0.

■Buffer memory address

The following table shows the buffer memory address of this area.

Buffer memory name	Axis 1	Axis 2
[Md.45] Block No. being executed	836	936

[Md.46] Last executed positioning data No.

This area stores the positioning data No. of the positioning data that was executed last time.

- The value is held until a new positioning operation is executed.
- When the JOG operation or inching operation is executed, 0 is stored.

■Buffer memory address

The following table shows the buffer memory address of this area.

Buffer memory name	Axis 1	Axis 2
[Md.46] Last executed positioning data No.	837	937

[Md.47] Positioning data being executed

The details of the positioning data currently being executed (data with the positioning data No. set by [Md.44] Positioning data No. being executed) are stored in the following buffer memory addresses.

Buffer memory address of this area		Stored item
Axis 1	Axis 2	
838	938	Positioning identifier <ul style="list-style-type: none"> • [Da.1] Operation pattern (Page 424) • [Da.2] Control method (Page 425) • [Da.3] Acceleration time No. (Page 426) • [Da.4] Deceleration time No. (Page 426) • [Da.5] Axis to be interpolated (Page 426)
839	939	[Da.10] M code (Page 432)
840	940	[Da.9] Dwell time (Page 431)
841	941	Positioning option <ul style="list-style-type: none"> • [Da.27] M code ON signal output timing (Page 432) • [Da.28] ABS direction in degrees (Page 433) • [Da.29] Interpolation speed specification method (Page 433)
842	942	[Da.8] Command speed (Page 430)
843	943	
844	944	[Da.6] Positioning address/movement amount (Page 427)
845	945	
846	946	[Da.7] Arc address (Page 429)
847	947	

[Md.60] Analysis mode

This area stores the positioning start mode currently being executed.

Analysis mode	Stored value
Normal analysis mode	0
Pre-analysis mode	1

■Buffer memory address

The following table shows the buffer memory address of this area.

Buffer memory name	Axis 1	Axis 2
[Md.60] Analysis mode	857	957

[Md.61] Analysis complete flag

This area stores the start preparation complete state in the pre-analysis mode.

Analysis complete flag	Stored value
Analysis not completed	0
Analysis completed	1

In the interpolation control, only the value of the reference axis is changed.

■Buffer memory address

The following table shows the buffer memory address of this area.

Buffer memory name	Axis 1	Axis 2
[Md.61] Analysis complete flag	858	958

[Md.48] Deceleration start flag

- When the speed status is changed from the constant speed or acceleration to deceleration during the position control whose operation pattern is Positioning complete, this area stores 1.
- At the next operation start or manual pulse generator operation enable, it stores 0.

■Buffer memory address

The following table shows the buffer memory address of this area.

Buffer memory name	Axis 1	Axis 2
[Md.48] Deceleration start flag	899	999

[Md.70] Amplifier-less operation mode status

This area stores the operation mode currently being executed.

Operation mode status	Stored value
In normal operation mode	0
In amplifier-less operation mode	1

■Buffer memory address

The following table shows the buffer memory address of this area.

Buffer memory name	Common for axes 1 and 2
[Md.70] Amplifier-less operation mode status	1201

17.8 Control Data

System control data

[Cd.1] Module data backup request

Set this area to write module extension parameters (positioning data and block start data) to the module extension parameter file.

Module data backup request	Setting value
Not requested	0
Requested	1

- After the data is written, 0 is automatically stored. Storing 0 indicates the completion of the writing.
- For details on the module data backup function, refer to the following.

☞ Page 312 Module Data Backup Function

■Buffer memory address

The following table shows the buffer memory address of this area.

Buffer memory name	Common for axes 1 and 2
[Cd.1] Module data backup request	1900

■Default value

The default value is 0.

[Cd.2] Module data initialization request

Set this area to initialize module parameters and module extension parameters (positioning data and block start data) in the buffer memory and setting values in the module extension parameter file to their factory default settings.

Module data initialization request	Setting value
Not requested	0
Requested	1

- After the data is initialized, 0 is automatically stored. Storing 0 indicates the completion of the initialization.
- After the data is initialized, turn on the system again, or reset the CPU module.
- For details on the module data initialization function, refer to the following.

☞ Page 310 Module Data Initialization Function

■Buffer memory address

The following table shows the buffer memory address of this area.

Buffer memory name	Common for axes 1 and 2
[Cd.2] Module data initialization request	1901

■Default value

The default value is 0.

[Cd.41] Deceleration start flag valid

Set whether to validate [Md.48] Deceleration start flag.

Deceleration start flag valid	Setting value
Deceleration start flag invalid	0
Deceleration start flag valid	1

■Buffer memory address

The following table shows the buffer memory address of this area.

Buffer memory name	Common for axes 1 and 2
[Cd.41] Deceleration start flag valid	1905

■Default value

The default value is 0: Deceleration start flag invalid.

[Cd.42] Stop command processing for deceleration stop selection

Set the stop command processing for deceleration stop function (deceleration curve re-processing or deceleration curve continuation).

Stop command processing for deceleration stop selection	Setting value
Deceleration curve re-processing	0
Deceleration curve continuation	1

■Buffer memory address

The following table shows the buffer memory address of this area.

Buffer memory name	Common for axes 1 and 2
[Cd.42] Stop command processing for deceleration stop selection	1907

■Default value

The default value is 0: Deceleration curve re-processing.

[Cd.43] Output timing selection of near pass control

Select the timing to output the difference (Δd) between the actual and the set positioning end addresses in continuous path control, in which the difference is output during the execution of the next positioning data.

Output timing selection of near pass control	Setting value
At constant speed	0
At deceleration	1

■Buffer memory address

The following table shows the buffer memory address of this area.

Buffer memory name	Common for axes 1 and 2
[Cd.43] Output timing selection of near pass control	1934

■Default value

The default value is 0: At constant speed.

[Cd.44] External input signal operation device

Set the external input signal status for the amplifier-less operation mode.

The setting of this area is applied from the buffer memory to the positioning module every 0.88 ms.

Setting item	Setting value
b0	Lower limit signal
b1	Upper limit signal
b2	Drive unit READY signal
b3	Stop signal
b4	External command signal
b5	Zero signal
b6	Near-point dog signal
b7 to b15	Use prohibited
	0: OFF 1: ON
	Set 0.

■Buffer memory address

The following table shows the buffer memory address of this area.

Buffer memory name	Axis 1	Axis 2
[Cd.44] External input signal operation device	1928	1929

■Default value

The default value is 0: OFF.

[Cd.49] All axes error reset

Clear the axis error detection, axis error No., axis warning detection, and axis warning No. for all the axes.

- Errors are cleared by setting 1: Reset axis errors for this area.
- After the error is reset, 0 is automatically stored. Storing 0 indicates the completion of the error reset.
- When the axis operation status is Error, this area clears the errors and sets the status of the positioning module to Standby again.

■Buffer memory address

The following table shows the buffer memory address of this area.

Buffer memory name	Common for axes 1 and 2
[Cd.49] All axes error reset	1933

■Default value

The default value is 0.

[Cd.137] Amplifier-less operation mode switching request

Switch the operation mode.

Amplifier-less operation mode switching request	Setting value
Switching from the normal operation mode to the amplifier-less operation mode	ABCDH
Switching from the amplifier-less operation mode to the normal operation mode	0000H

■Buffer memory address

The following table shows the buffer memory address of this area.

Buffer memory name	Common for axes 1 and 2
[Cd.137] Amplifier-less operation mode switching request	1926

■Default value

The default value is 0000H.

[Cd.190] PLC READY signal

This signal notifies the positioning module that the CPU module is normal. This signal is turned on and off with the program. The PLC READY signal is turned on during the positioning control, OPR control, JOG operation, inching operation, and manual pulse generator operation, unless the system is in the GX Works3 test mode.

When data (including parameters) has been changed, the [Cd.190] PLC READY signal is turned off depending on the changed item.

The following processing occurs when the [Cd.190] PLC READY signal transitions from off to on.

- The parameter setting range is checked.
- The READY ([Md.140] Module status: b0) signal turns on.

The following processing occurs when the PLC READY signal transitions from off to on. In this case, the OFF time should be set to 100 ms or more.

- The READY ([Md.140] Module status: b0) signal turns off.
- The operating axis stops.
- M code ON signal ([Md.31] Status: b12) for each axis turns off, and 0 is stored in [Md.25] Valid M code.

The [Cd.190] PLC READY signal turns off when using GX Works3, or module data backup or module data initialization by the CPU module.

The acquisition cycle of the [Cd.190] PLC READY signal is the same as the calculation cycle.

PLC READY signal	Setting value
PLC READY signal ON	1
PLC READY signal OFF	Other than 1

■Buffer memory address

The following table shows the buffer memory address of this area.

Buffer memory name	Common for axes 1 and 2
[Cd.190] PLC READY signal	1950

■Default value

The default value is 0.

Axis control data

[Cd.3] Positioning start No.

Set the positioning start No.

Positioning start No.	Setting value
Positioning data No.	1 to 600
Block start specification	7000 to 7004
Machine OPR	9001
Fast OPR	9002
Current value change	9003
Multiple axes simultaneous start	9004

*1 Only 1 to 600 can be set for the pre-reading start function.

■Buffer memory address

The following table shows the buffer memory address of this area.

Buffer memory name	Axis 1	Axis 2
[Cd.3] Positioning start No.	1500	1600

■Default value

The default value is 0.

[Cd.4] Positioning starting point No.

Set Starting point No. (1 to 50) to use block start data for positioning. (If a value other than 1 to 50 is set, the value is handled as 1.)

■Buffer memory address

The following table shows the buffer memory address of this area.

Buffer memory name	Axis 1	Axis 2
[Cd.4] Positioning starting point No.	1501	1601

■Setting range

The setting range is 1 to 50.

■Default value

The default value is 0 for all the axes.

[Cd.5] Axis error reset

Clear the axis error detection, axis error No., axis warning detection, and axis warning No for each axis.

- Errors are cleared by setting 1: Reset axis errors for this area.
- After the error is reset, 0 is automatically stored. Storing 0 indicates the completion of the error reset.
- When the axis operation status is Error, this area clears the errors and sets the status of the positioning module to Standby again.

■Buffer memory address

The following table shows the buffer memory address of this area.

Buffer memory name	Axis 1	Axis 2
[Cd.5] Axis error reset	1502	1602

■Default value

The default value is 0 for all the axes.

[Cd.6] Restart command

Set this area to restart positioning from the stop status.

- When positioning is stopped for any reason (when the axis operation status is Stopped), setting 1: Restart for this area performs the positioning again from the stop position to the end point of the stopped positioning data.
- After the restart command is accepted, 0 is automatically stored. Storing 0 indicates the completion of the restart command acceptance.

■Buffer memory address

The following table shows the buffer memory address of this area.

Buffer memory name	Axis 1	Axis 2
[Cd.6] Restart command	1503	1603

■Default value

The default value is 0 for all the axes.

[Cd.7] M code ON signal OFF request

Set this area to turn off M code ON signal ([Md.31] Status: b12).

- M code ON signal ([Md.31] Status: b12) is turned off by setting 1: M code ON signal is turned off for this Area.
- After the OFF request is accepted, 0 is automatically stored. Storing 0 indicates the completion of the OFF request acceptance.

■Buffer memory address

The following table shows the buffer memory address of this area.

Buffer memory name	Axis 1	Axis 2
[Cd.7] M code ON signal OFF request	1504	1604

■Default value

The default value is 0 for all the axes.

[Cd.8] External command valid

Set whether to validate external command signals.

External command valid	Setting value
Invalidate external command	0
Validate external command	1

■Buffer memory address

The following table shows the buffer memory address of this area.

Buffer memory name	Axis 1	Axis 2
[Cd.8] External command valid	1505	1605

■Default value

The default value is 0: Invalidate external command for all the axes.

[Cd.9] New current value

Set a new feed value to change the current feed value using the start No. 9003.

■Buffer memory address

The following table shows the buffer memory address of this area.

Buffer memory name	Axis 1	Axis 2
[Cd.9] New current value	1506	1606
	1507	1607

■Setting range

The setting range depends on the setting of [Pr.1] Unit setting.

Setting of [Pr.1] Unit setting	Setting value with programs
0: mm	-2147483648 to 2147483647 ($\times 10^{-1}\mu\text{m}$)
1: inch	-2147483648 to 2147483647 ($\times 10^{-5}\text{inch}$)
2: degree	0 to 35999999 ($\times 10^{-5}\text{degree}$)
3: pulse	-2147483648 to 2147483647 (pulse)

■Default value

The default value is 0 for all the axes.

[Cd.10] New acceleration time value

When changing the acceleration time during a speed change, use this area to specify a new acceleration time value in units of ms. When 0 is set, the acceleration time is not changed.

■Buffer memory address

The following table shows the buffer memory address of this area.

Buffer memory name	Axis 1	Axis 2
[Cd.10] New acceleration time value	1508	1608
	1509	1609

■Setting range

The setting range is 0 to 8388608.

■Default value

The default value is 0 for all the axes.

[Cd.11] New deceleration time value

When changing the deceleration time during a speed change, use this area to specify a new deceleration time in units of ms. When 0 is set, the deceleration time is not changed.

■Buffer memory address

The following table shows the buffer memory address of this area.

Buffer memory name	Axis 1	Axis 2
[Cd.11] New deceleration time value	1510	1610
	1511	1611

■Setting range

The setting range is 0 to 8388608.

■Default value

The default value is 0 for all the axes.

[Cd.12] Acceleration/deceleration time change during speed change, enable/disable selection

Set whether to enable modifications to the acceleration/deceleration time during a speed change.

Acceleration/deceleration time change during speed change, enable/disable selection	Setting value
Acceleration/deceleration time change enabled	1
Acceleration/deceleration time change disabled	Other than 1

■Buffer memory address

The following table shows the buffer memory address of this area.

Buffer memory name	Axis 1	Axis 2
[Cd.12] Acceleration/deceleration time change during speed change, enable/disable selection	1512	1612

■Default value

The default value is 0 for all the axes.

[Cd.13] Positioning operation speed override

When using the positioning operation speed override function, use this area to specify the value of Override in units of %.

- If the speed becomes lower than the minimum unit due to override 1% or other causes, the speed is raised to the minimum unit. At this time, Less than speed 1 (Warning code: 0904H) occurs.
- When 0% is set, the speed is set to 0 and Speed change 0 flag ([Md.31] Status: b10) is set to 1. In this case, no warning occurs.

■Buffer memory address

The following table shows the buffer memory address of this area.

Buffer memory name	Axis 1	Axis 2
[Cd.13] Positioning operation speed override	1513	1613

■Setting range

The setting range is 0 to 300.

■Default value

The default value is 100 for all the axes.

[Cd.14] New speed value

Set a new speed value when changing speed. When 0 is set, the axis stops and BUSY signal remains on.

■Buffer memory address

The following table shows the buffer memory address of this area.

Buffer memory name	Axis 1	Axis 2
[Cd.14] New speed value	1514	1614
	1515	1615

■Setting range

The setting range depends on the setting of [Pr.1] Unit setting.

Setting of [Pr.1] Unit setting	Setting value with programs
0: mm	0 to 2000000000 ($\times 10^{-2}$ mm/min)
1: inch	0 to 2000000000 ($\times 10^{-3}$ inch/min)
2: degree	0 to 3000000000 ($\times 10^{-3}$ degree/min)
3: pulse	0 to 5000000 (pulse/s)

■Default value

The default value is 0 for all the axes.

[Cd.15] Speed change request

Set this area to request a speed change.

- After setting [Cd.14] New speed value, set 1: Change the speed to request a speed change (validate the value set in [Cd.14] New speed value).
- After the speed change is accepted, 0 is automatically stored. Storing 0 indicates the completion of the speed change acceptance.

■Buffer memory address

The following table shows the buffer memory address of this area.

Buffer memory name	Axis 1	Axis 2
[Cd.15] Speed change request	1516	1616

■Default value

The default value is 0.

[Cd.16] Inching movement amount

Set the inching movement amount. When 0 is set, the JOG operation is performed.

■Buffer memory address

The following table shows the buffer memory address of this area.

Buffer memory name	Axis 1	Axis 2
[Cd.16] Inching movement amount	1517	1617

■Setting range

The setting range depends on the setting of [Pr.1] Unit setting.

Setting of [Pr.1] Unit setting	Setting value with programs
0: mm	0 to 65535 ($\times 10^{-1}\mu\text{m}$)
1: inch	0 to 65535 ($\times 10^{-5}\text{inch}$)
2: degree	0 to 65535 ($\times 10^{-5}\text{degree}$)
3: pulse	0 to 65535 (pulse)

■Default value

The default value is 0 for all the axes.

[Cd.17] JOG speed

Set JOG speed for JOG operation.

■Buffer memory address

The following table shows the buffer memory address of this area.

Buffer memory name	Axis 1	Axis 2
[Cd.17] JOG speed	1518	1618
	1519	1619

■Setting range

The setting range depends on the setting of [Pr.1] Unit setting.

Setting of [Pr.1] Unit setting	Setting value with programs
0: mm	0 to 2000000000 ($\times 10^{-2}\text{mm/min}$)
1: inch	0 to 2000000000 ($\times 10^{-3}\text{inch/min}$)
2: degree	0 to 3000000000 ($\times 10^{-3}\text{degree/min}$)
3: pulse	0 to 5000000 (pulse/s)

■Default value

The default value is 0 for all the axes.

[Cd.18] Continuous operation interrupt request

Set this area to interrupt continuous operation.

- The continuous operation is interrupted by setting 1: Interrupt continuous control or continuous path control for this area.
- After the continuous operation interruption is accepted, 0 is automatically stored. Storing 0 indicates the completion of the continuous operation interruption.

■Buffer memory address

The following table shows the buffer memory address of this area.

Buffer memory name	Axis 1	Axis 2
[Cd.18] Continuous operation interrupt request	1520	1620

■Default value

The default value is 0 for all the axes.

[Cd.19] OPR request flag OFF request

Set this area to request to forcibly turn off the OPR request flag with the program when the flag is on.

- The OPR request flag is turned off by setting 1: Turn off OPR request flag for this area.
- After the OPR request flag is turned off, 0 is automatically stored. Storing 0 indicates the completion of the OPR request flag OFF request.

■Buffer memory address

The following table shows the buffer memory address of this area.

Buffer memory name	Axis 1	Axis 2
[Cd.19] OPR request flag OFF request	1521	1621

■Default value

The default value is 0 for all the axes.

[Cd.20] Manual pulse generator 1 pulse input magnification

Set the factor by which the number of pulses from the manual pulse generator is magnified.

- When the setting value is 0, the value is handled as 1.
- When the setting value is 10001 or greater, the value is handled as 10000.

■Buffer memory address

The following table shows the buffer memory address of this area.

Buffer memory name	Axis 1	Axis 2
[Cd.20] Manual pulse generator 1 pulse input magnification	1522	1622
	1523	1623

■Setting range

The setting range is 1 to 10000.

■Default value

The default value is 1 for all the axes.

[Cd.21] Manual pulse generator enable flag

Set whether to enable manual pulse generator operations.

Manual pulse generator enable flag	Setting value
Disable manual pulse generator operation	0
Enable manual pulse generator operation	1

■Buffer memory address

The following table shows the buffer memory address of this area.

Buffer memory name	Axis 1	Axis 2
[Cd.21] Manual pulse generator enable flag	1524	1624

■Default value

The default value is 0: Disable manual pulse generator operation for all the axes.

[Cd.22] New torque value

To change the value set in [Md.35] Torque limit stored value, set a new torque limit stored value in units of %.

- Set a value within the allowable range of [Pr.17] Torque limit setting value.
- When 0 is set, the torque is not changed.

■Buffer memory address

The following table shows the buffer memory address of this area.

Buffer memory name	Axis 1	Axis 2
[Cd.22] New torque value	1525	1625

■Setting range

The setting range is between 0 to [Pr.17] Torque limit setting value.

■Default value

The default value is 0 for all the axes.

[Cd.23] Speed-position switching control movement amount change register

During the speed control of the speed-position switching control (INC mode), the movement amount during the position control can be changed. For that, set a new movement amount.

- Set the new movement amount during the speed control of the speed-position switching control (INC mode).
- The setting value is cleared to 0 when the next operation starts.

■Buffer memory address

The following table shows the buffer memory address of this area.

Buffer memory name	Axis 1	Axis 2
[Cd.23] Speed-position switching control movement amount change register	1526	1626
	1527	1627

■Setting range

The setting range depends on the setting of [Pr.1] Unit setting.

Setting of [Pr.1] Unit setting	Setting value with programs
0: mm	0 to 2147483647 ($\times 10^{-1}\mu\text{m}$)
1: inch	0 to 2147483647 ($\times 10^{-5}\text{inch}$)
2: degree	0 to 2147483647 ($\times 10^{-5}\text{degree}$)
3: pulse	0 to 2147483647 (pulse)

■Default value

The default value is 0 for all the axes.

[Cd.24] Speed-position switching enable flag

Set whether to enable the external control signal (External command signal (CHG): Speed-position/position-speed switching request is selected).

Speed-position switching enable flag	Setting value
Speed control is not switched to position control even when External command signal (CHG) is turned on	0
Speed control is switched to position control when External command signal (CHG) is turned on	1

■Buffer memory address

The following table shows the buffer memory address of this area.

Buffer memory name	Axis 1	Axis 2
[Cd.24] Speed-position switching enable flag	1528	1628

■Default value

The default value is 0: Speed control is switched to position control when External command signal (CHG) is turned on for all the axes.

[Cd.25] Position-speed switching control speed change register

During the position control of the position-speed switching control, the speed during the speed control can be changed. For that, set a new speed.

- Set the new speed during the position control of the position-speed switching control.
- The setting value is cleared to 0 when the next operation starts.

■Buffer memory address

The following table shows the buffer memory address of this area.

Buffer memory name	Axis 1	Axis 2
[Cd.25] Position-speed switching control speed change register	1530	1630
	1531	1631

■Setting range

The setting range depends on the setting of [Pr.1] Unit setting.

Setting of [Pr.1] Unit setting	Setting value with programs
0: mm	0 to 2000000000 ($\times 10^{-2}$ mm/min)
1: inch	0 to 2000000000 ($\times 10^{-3}$ inch/min)
2: degree	0 to 3000000000 ($\times 10^{-3}$ degree/min)
3: pulse	0 to 5000000 (pulse/s)

■Default value

The default value is 0 for all the axes.

[Cd.26] Position-speed switching enable flag

Set whether to enable the external control signal (External command signal (CHG): Speed-position/position-speed switching request is selected).

Position-speed switching enable flag	Setting value
Position control is not switched to speed control even when External command signal (CHG) is turned on	0
Position control is switched to speed control when External command signal (CHG) is turned on	1

■Buffer memory address

The following table shows the buffer memory address of this area.

Buffer memory name	Axis 1	Axis 2
[Cd.26] Position-speed switching enable flag	1532	1632

■Default value

The default value is 0: Position control is not switched to speed control even when External command signal (CHG) is turned on.

[Cd.27] Target position change value (new address)

Set a new positioning address to change the target position during positioning.

■Buffer memory address

The following table shows the buffer memory address of this area.

Buffer memory name	Axis 1	Axis 2
[Cd.27] Target position change value (new address)	1534	1634
	1535	1635

■Setting range

The setting range depends on the setting of [Pr.1] Unit setting.

Setting of [Pr.1] Unit setting	Setting value with programs (ABS)	Setting value with programs (INC)
0: mm	-2147483648 to 2147483647 ($\times 10^{-1}\mu\text{m}$)	-2147483648 to 2147483647 ($\times 10^{-1}\mu\text{m}$)
1: inch	-2147483648 to 2147483647 ($\times 10^{-5}\text{inch}$)	-2147483648 to 2147483647 ($\times 10^{-5}\text{inch}$)
2: degree	0 to 35999999 ($\times 10^{-5}\text{degree}$)	-2147483648 to 2147483647 ($\times 10^{-5}\text{degree}$)
3: pulse	-2147483648 to 2147483647 (pulse)	-2147483648 to 2147483647 (pulse)

■Default value

The default value is 0 for all the axes.

[Cd.28] Target position change value (new speed)

Set a new speed to change the target position during positioning. When 0 is set, the speed is not changed.

■Buffer memory address

The following table shows the buffer memory address of this area.

Buffer memory name	Axis 1	Axis 2
[Cd.28] Target position change value (new speed)	1536	1636
	1537	1637

■Setting range

The setting range depends on the setting of [Pr.1] Unit setting.

Setting of [Pr.1] Unit setting	Setting value with programs
0: mm	0 to 2000000000 ($\times 10^{-2}\text{mm/min}$)
1: inch	0 to 2000000000 ($\times 10^{-3}\text{inch/min}$)
2: degree	0 to 3000000000 ($\times 10^{-3}\text{degree/min}$)
3: pulse	0 to 5000000 (pulse/s)

■Default value

The default value is 0 for all the axes.

[Cd.29] Target position change request flag

Set whether to change the target position during positioning.

- The target position is changed by setting 1: Target position change request for this area.
- After the target position is changed, 0 is automatically stored. Storing 0 indicates the completion of the target position change.

■Buffer memory address

The following table shows the buffer memory address of this area.

Buffer memory name	Axis 1	Axis 2
[Cd.29] Target position change request flag	1538	1638

■Default value

The default value is 0 for all the axes.

[Cd.30] Simultaneous starting axis start data No. (Axis 1 start data No.)

Set the simultaneous starting axis start data No.

■Buffer memory address

The following table shows the buffer memory address of this area.

Buffer memory name	Axis 1	Axis 2
[Cd.30] Simultaneous starting axis start data No. (Axis 1 start data No.)	1540	1640

■Setting range

The setting range is 1 to 600.

■Default value

The default value is 0 for all the axes.

[Cd.31] Simultaneous starting axis start data No. (Axis 2 start data No.)

Set the simultaneous starting axis start data No.

■Buffer memory address

The following table shows the buffer memory address of this area.

Buffer memory name	Axis 1	Axis 2
[Cd.31] Simultaneous starting axis start data No. (Axis 2 start data No.)	1541	1641

■Setting range

The setting range is 1 to 600.

■Default value

The default value is 0 for all the axes.

[Cd.34] Step mode

Set the units by which a step operation is carried out.

Step mode	Setting value
Carry out step operation in deceleration units	0
Carry out step operation in data No. units	1

■Buffer memory address

The following table shows the buffer memory address of this area.

Buffer memory name	Axis 1	Axis 2
[Cd.34] Step mode	1544	1644

■Default value

The default value is 0: Carry out step operation in deceleration units for all the axes.

[Cd.35] Step valid flag

Set whether to validate step operations.

Step valid flag	Setting value
Do not carry out step operation	0
Carry out step operation	1

■Buffer memory address

The following table shows the buffer memory address of this area.

Buffer memory name	Axis 1	Axis 2
[Cd.35] Step valid flag	1545	1645

■Default value

The default value is 0: Do not carry out step operation for all the axes.

[Cd.36] Step start request

When the step function is used, set this area to continue the operation stopped by the step operation.

- The step operation continues by setting 1: Continue step operation for this area of the axis where step operation is stopped correctly.
- After the step start request is accepted, 0 is automatically stored. Storing 0 indicates the completion of the step start request acceptance.

■Buffer memory address

The following table shows the buffer memory address of this area.

Buffer memory name	Axis 1	Axis 2
[Cd.36] Step start request	1546	1646

■Default value

The default value is 0 for all the axes.

[Cd.37] Skip command

Set this area to skip the current positioning operation.

- The current positioning operation is skipped and the next positioning starts by setting 1: Issue a skip command to execute the machine deceleration, stop, and start the next positioning operation for this area.
- After the skip request is accepted, 0 is automatically stored. Storing 0 indicates the completion of the skip request.

■Buffer memory address

The following table shows the buffer memory address of this area.

Buffer memory name	Axis 1	Axis 2
[Cd.37] Skip command	1547	1647

■Default value

The default value is 0 for all the axes.

[Cd.38] Teaching data selection

Set the data to which the teaching result is written. When the teaching has been completed, this data is cleared to 0.

Teaching data selection	Setting value
Take the current feed value as a positioning address	0
Take the current feed value as arc data	1

■Buffer memory address

The following table shows the buffer memory address of this area.

Buffer memory name	Axis 1	Axis 2
[Cd.38] Teaching data selection	1548	1648

■Default value

The default value is 0: Take the current feed value as a positioning address for all the axes.

[Cd.39] Teaching positioning data No.

Specify the positioning data No. for teaching.

- Teaching is performed when the set value is 1 to 600.
- The value is cleared to 0 when teaching completed. It is also cleared to 0 when an illegal value (601 or greater) is entered.

■Buffer memory address

The following table shows the buffer memory address of this area.

Buffer memory name	Axis 1	Axis 2
[Cd.39] Teaching positioning data No.	1549	1649

■Setting range

The setting range is 1 to 600.

■Default value

The default value is 0 for all the axes.

[Cd.40] ABS direction in degrees

Set the ABS movement direction for the position control when the unit is degree.

ABS direction in degrees	Setting value
Shortcut (Direction setting invalid)	0
ABS clockwise	1
ABS counterclockwise	2

■Buffer memory address

The following table shows the buffer memory address of this area.

Buffer memory name	Axis 1	Axis 2
[Cd.40] ABS direction in degrees	1550	1650

■Default value

The default value is 0: Shortcut (Direction setting invalid) for all the axes.

[Cd.45] Speed↔position switching device selection

Select the device used for the speed to position switching.

Speed-position switching device selection		Setting value
Speed-position switching control	Position-speed switching control	
External command signal is used for switching speed control to position control	External command signal is used for switching position control to speed control	0
Near-point dog signal is used for switching speed control to position control	Near-point dog signal is used for switching position control to speed control	1
[Cd.46] Speed-position switching command is used for switching speed control to position control	[Cd.46] Speed-position switching command is used for switching position control to speed control	2

When the setting value is out of the setting range at the start, the value is handled as 0.

■Buffer memory address

The following table shows the buffer memory address of this area.

Buffer memory name	Axis 1	Axis 2
[Cd.45] Speed-position switching device selection	1566	1666

■Default value

The default value is 0 for all the axes.

[Cd.46] Speed↔position switching command

Switch the control between speed control and position switching when 2 is set in [Cd.45] Speed-position switching device selection. Only when [Cd.45] Speed-position switching device selection starts with 2, this area is enabled.

Speed-position switching device selection		Setting value
Speed-position switching control	Position-speed switching control	
Speed control is not switched to position control	Position control is not switched to speed control	0
Speed control is switched to position control	Position control is switched to speed control	1

- When 1 is set for this area, the position control is switched to the speed control and the speed control is switched to the position control.
- When the speed-position switching command is accepted, 0 is automatically stored. Storing 0 indicates the completion of the speed-position switching command acceptance.

■Buffer memory address

The following table shows the buffer memory address of this area.

Buffer memory name	Axis 1	Axis 2
[Cd.46] Speed-position switching command	1567	1667

■Default value

The default value is 0 for all the axes.

[Cd.43] Analysis mode setting

Set the positioning start mode.

Analysis mode setting	Setting value
Normal analysis mode	0
Pre-analysis mode	1

■Buffer memory address

The following table shows the buffer memory address of this area.

Buffer memory name	Axis 1	Axis 2
[Cd.43] Analysis mode setting	1590	1690

■Default value

The default value is 0 for all the axes.

[Cd.180] Axis stop signal

- When Axis stop signal is turned on, the OPR control, positioning control, JOG operation, inching operation, and manual pulse generator operation will stop.
- By turning on the axis stop signal during the positioning operation, the operation will be stopped.
- Whether to decelerate or suddenly stop can be selected with [Pr.39] Stop group 3 sudden stop selection.
- During the interpolation control of the positioning operation, if the axis stop signal of any axis is turned on, all axes in the interpolation control will decelerate and stop.
- The acquisition cycle of the axis stop signal is the same as the calculation cycle.

Axis stop signal	Setting value
Axis stop request	1
No axis stop request	Other than 1

■Buffer memory address

The following table shows the buffer memory address of this area.

Buffer memory name	Axis 1	Axis 2
[Cd.180] Axis stop signal	30100	30110

■Default value

The default value is 0 for all the axes.

[Cd.181] Forward JOG start signal, [Cd.182] Reverse JOG start signal

- When the JOG start signal is on, JOG operation is performed per [Cd.17] JOG speed. When this signal is turned off, the operation will decelerate and stop.
- When an inching movement amount is set, the specified movement amount is output for 1.77 ms, and then the operation stops.
- The acquisition cycle of the JOG start signal is the same as the calculation cycle.

Forward JOG start signal, Reverse JOG start signal	Setting value
JOG started	1
JOG not started	Other than 1

■Buffer memory address

The following table shows the buffer memory address of this area.

Buffer memory name	Axis 1	Axis 2
[Cd.181] Forward JOG start signal	30101	30111
[Cd.182] Reverse JOG start signal	30102	30112

■Default value

The default value is 0 for all the axes.

[Cd.183] Execution prohibition flag

- If the Execution prohibition flag is on when the Positioning start signal turns on, positioning control does not start until this flag turns off. (no pulse output)
- The Execution prohibition flag is acquired when positioning starts.

Execution prohibition flag	Setting value
During execution prohibition	1
Not during execution prohibition	Other than 1

For details on the pre-reading start function, refer to the following.

☞ Page 266 Pre-reading start function

■Buffer memory address

The following table shows the buffer memory address of this area.

Buffer memory name	Axis 1	Axis 2
[Cd.183] Execution prohibition flag	30103	30113

■Default value

The default value is 0 for all the axes.

[Cd.184] Positioning start signal

The OPR operation or positioning operation is started.

- Positioning start signal is valid at the rising edge, and the operation is started.
- The Start during operation warning (warning code: H0900) occurs when the positioning start signal turns on during the BUSY state.
- The positioning start signal is acquired immediately.

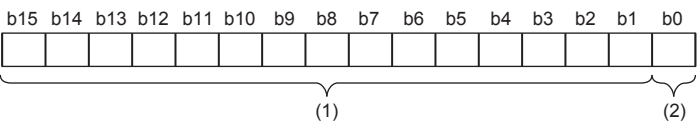
Buffer memory configuration	Stored contents	Stored value
b15 b14 b13 b12 b11 b10 b9 b8 b7 b6 b5 b4 b3 b2 b1 b0 	(1) Use prohibited	Fixed to 0
	(2) Positioning start request	0, 1

■Positioning start request ([Cd.184] Positioning start signal: b0)

- 0: No positioning start request
- 1: Positioning start request

■Buffer memory address

The following table shows the buffer memory address of this area.

Buffer memory name	Axis 1	Axis 2
[Cd.184] Positioning start signal	30104	30114

■Default value

The default value is 0: No positioning start request for all axes.

17.9 Interrupt Setting

[Md.65] Interrupt factor detection flag

This area stores the detecting status of an interrupt factor.

Interrupt factor detection flag	Stored value
Interrupt factor not detected	0
Interrupt factor detected	1

■Buffer memory address

For the buffer memory address of this area, refer to the following.

☞ Page 383 Interrupt setting

[Cd.50] Interrupt factor mask

Set the interrupt factor mask.

Interrupt factor mask	Setting value
Mask (disable interruption)	0
Clear mask (enable interruption)	1

■Buffer memory address

For the buffer memory address of this area, refer to the following.

☞ Page 383 Interrupt setting

■Default value

The default value is 0: Mask.

[Cd.51] Interrupt factor reset request

Perform the interrupt factor reset request.

Interrupt factor reset request	Setting value
No reset request	0
Reset request	1

- The interrupt factor is reset by setting 1: Reset request for this area.
- When the interrupt factor reset request acceptance is completed, 0: No reset request is automatically stored. Storing 0 indicates the completion of the interrupt factor reset request.

■Buffer memory address

For the buffer memory address of this area, refer to the following.

☞ Page 383 Interrupt setting

■Default value

The default value is 0: No reset request.

[Pr.900] Interrupt factor setting

Specify the target (module) for the interrupt detection. The following table lists the available targets.

Interrupt factor setting	Detection timing	Setting value
Do not detect	OFF → ON	0
M code ON		1
Error detection		2
BUSY		3
Start complete		4
Positioning complete		5
Lower limit signal ([Md.30] External I/O signal)	ON → OFF	100
Upper limit signal ([Md.30] External I/O signal)		101
Drive unit READY ([Md.30] External I/O signal)		102
Stop signal ([Md.30] External I/O signal)	OFF → ON	103
External command signal ([Md.30] External I/O signal)		104
Zero signal ([Md.30] External I/O signal)		105
Near-point dog signal ([Md.30] External I/O signal)		106
Deviation counter clear signal ([Md.30] External I/O signal)		107
In speed control flag ([Md.31] Status)		200
Speed-position switching latch flag ([Md.31] Status)		201
Command in-position flag ([Md.31] Status)		202
OPR request flag ([Md.31] Status)		203
OPR complete flag ([Md.31] Status)		204
Position-speed switching latch flag ([Md.31] Status)		205
Warning detection ([Md.31] Status)		206
Speed change 0 flag ([Md.31] Status)		207
[Md.48] Deceleration start flag		300
[Md.61] Analysis complete flag		301

■Buffer memory address

For the buffer memory address of this area, refer to the following.

☞ Page 383 Interrupt setting

■Default value

The default value is 0: Do not detect.

[Pr.901] Axis No. for interrupt factor

Set the axis number in which an interrupt factor is detected.

Axis No. for interrupt factor	Setting value
All axes	0
Axis 1	1
Axis 2	2

■Buffer memory address

For the buffer memory address of this area, refer to the following.

☞ Page 383 Interrupt setting

■Default value

The default value is 0: All axes.

17.10 Basic Parameter 3

This section describes the basic parameter 3 of the positioning module. The storage location of module extension parameters can be changed with the basic parameter 3. The basic parameter 3 can be changed only with "Module Parameter" in GX Works3.

For the setting method, refer to the following.

 Page 324 Basic setting

Extended parameter storage setting

Set the storage location for module extension parameters. The setting is the same for all the axes.

Extended parameter storage setting	Description
CPU	The module extension parameters stored in the CPU module are used. <ul style="list-style-type: none">• When the power is turned on or the CPU module status is changed from STOP to RUN, the module extension parameters in the module extension parameter file stored in the CPU module are reflected to the buffer memory.• At the module data backup or module data initialization, the parameters are reflected to the module extension parameter file stored in the CPU module.
Positioning module	The module extension parameters stored in the positioning module are used. <ul style="list-style-type: none">• When the power is turned on, the module extension parameters in the module extension parameter file stored in the positioning module are reflected to the buffer memory. When the CPU module status is changed from STOP to RUN, the value just before the status change is held.• At the module data backup or module data initialization, the parameters are reflected to the module extension parameter file stored in the positioning module.

17.11 Parameter Reflection

The parameters of the positioning module are classified into the module parameter and module extension parameter. The parameters are stored in the CPU module or the positioning module as a module parameter file and module extension parameter file.

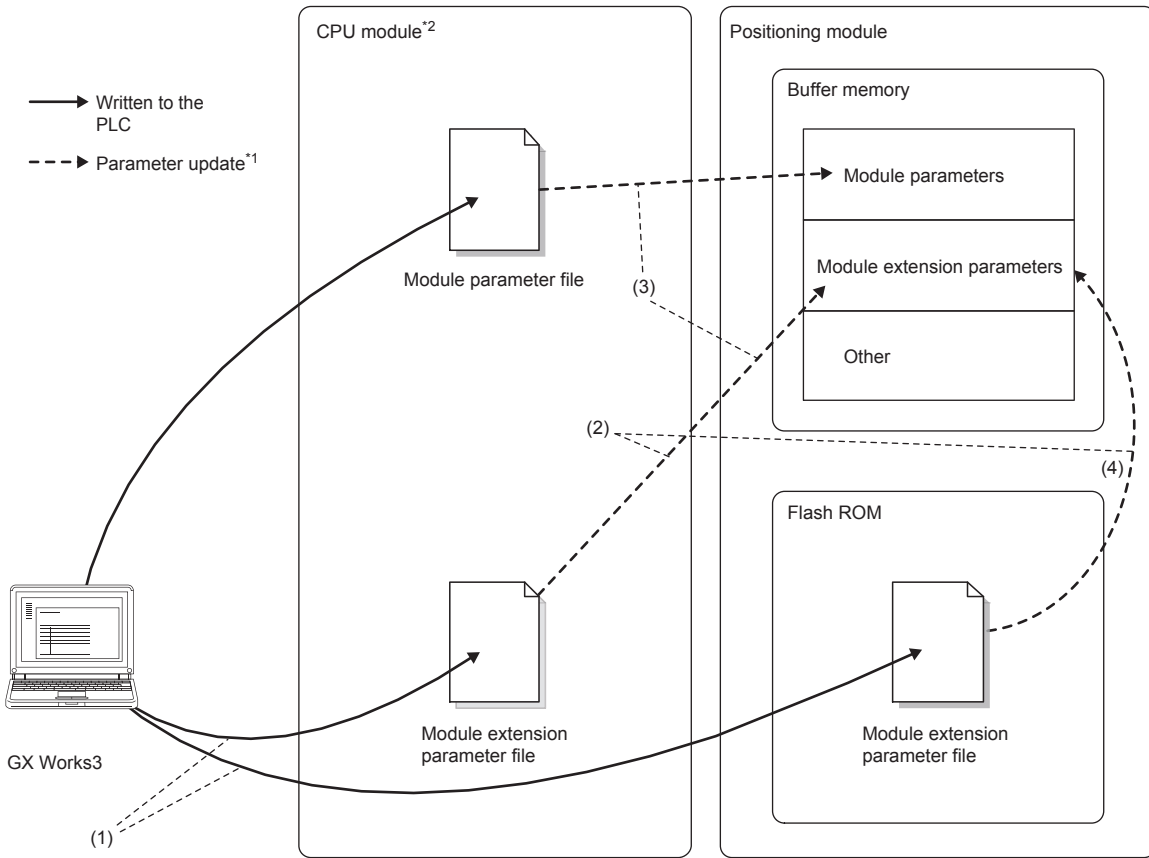

- (1) Select a write destination (CPU module or positioning module) with "Write to PLC".
- (2) "Extension parameter storage setting" determines whether the file in the CPU module is used or the file in the positioning module is used.
- (3) The power is turned on or the CPU module status is changed from STOP to RUN.
- (4) Power-on

*1 For the reflection timing of parameters, refer to the following.

☞ Page 487 Parameter storage destination and reflection timing

*2 "Memory Card Parameters" of the CPU module determines whether the parameter file in the CPU module is used or the parameter file in the SD memory card is used.

Parameter storage destination and reflection timing

The following table lists the parameter storage destinations.

Parameter file	Parameter		Storage destination	
	Type	Item		
Module parameter file	Module parameter	Basic setting	CPU module	
		Application setting		• Basic parameter 1,2 • Detailed parameter 1, 2 • OPR basic parameter • OPR detailed parameter
		Interrupt setting		CPU error output mode setting Parameters for the Interrupt setting
Module extension parameter file	Module extension parameter	Positioning data	CPU module or positioning module*1	
		Block start data		Positioning data Block start data
		Condition data		Condition data

*1 The storage destination differs depending on the extension parameter storage setting. For details, refer to the following.

☞ Page 486 Extended parameter storage setting

Each parameter is reflected to the buffer memory of the positioning module at the following reflection timings.

Parameter storage timing	Operation	Parameter setting value reflected to the buffer memory		
		Module parameter ^{*2}	Module extension parameter ^{*3} (Extension parameter storage setting)	
			CPU module	Positioning module
Power-on	Power-on	Setting value of the module parameter file in the CPU module ^{*4}	Setting value of the module extension parameter file in the CPU module	Setting value of the module extension parameter file in the positioning module
CPU module status: STOP → RUN	CPU module status: STOP → RUN			The parameter just before the status change of STOP to RUN is held.
Module data initialization	<ul style="list-style-type: none"> Dedicated instruction (GP.PINIT) [Cd.2] Module data initialization request 	Initial value (factory default setting value)		

*2 Some module parameters are reflected to the positioning module from the buffer memory by turning off and on [Cd.190] PLC READY signal. For details, refer to the following.

☞ Page 354 Valid timing of setting data

*3 When the parameter to be reflected does not exist at the reflection timing, refer to the following.

☞ Page 489 Parameter reflection

*4 If the parameter is not set with GX Works3, the initial value is stored.

■Precautions

- To write module extension parameters to a file, specify the same write destination as the one set in the extension parameter storage setting. When a different write destination is specified, written module extension parameters are not valid. When the module extension parameter file does not exist in the storage destination set in the extension parameter storage setting, Extension parameter acquisition error (Warning code: 0B00H) occurs at the reflection timing.
- To change a module extension parameter from a program when the extension parameter storage setting is "CPU", change the parameter while Module access flag ([Md.140] Module status: b1) is on (module access permitted). While Module access flag is off (module access disabled), the module extension parameter is changed by the internal processing of the positioning module.
- To use the module extension parameters stored in the SD memory card of the CPU module, set the storage location to "CPU" in the extension parameter storage setting. Set "Memory Card Parameters" of the CPU module so that module extension parameters can be used.

■Restrictions

- Extension parameter storage settings can only be changed in GX Works3. These settings cannot be changed with programs.
- When the extension parameter storage setting has been set to "CPU", the module data backup and the module data initialization can be performed only while the CPU module status is STOP. Use "[Cd.1] Module data backup request" for the module data backup and "[Cd.2] Module data initialization request" for the module data initialization.
- Changes to module parameters and module extensions parameters stored in the CPU module take effect when the CPU module is turned off and on again, or a reset is performed. The CPU module cannot transition to the RUN state until the power to the CPU module is turned off and on again or a reset is performed.

Parameter reflection

In the positioning module, the parameter is reflected to the buffer memory at power-on or when the CPU module status is changed from STOP to RUN. The following table shows the parameters reflected to the buffer memory.

Parameter type	Extended parameter storage setting	Power-on	CPU module status: STOP → RUN
Module parameter	—	Parameter stored in the CPU module ^{*1}	
Module extension parameter ^{*1}	CPU	Module extension parameter stored in the CPU module or SD memory card	
	Positioning module	Module extension parameters stored in the positioning module ^{*2}	—

*1 When the parameter of the positioning module does not exist in the CPU module, the setting value of the buffer memory is the factory default value at power-on and the value just before the status change is held when the CPU module status is changed from STOP to RUN.

*2 When the data in the positioning module is damaged, Flash ROM sum check error (Error code: 1932H) occurs.

Point

When a module extension parameter is changed with a program, the changed module extension parameter can be reflected to the buffer memory when the power is turned on or the CPU module status is changed from STOP to RUN.

Precautions

- When the CPU is set in the extension parameter storage setting and the module extension parameter cannot be reflected at power-on or the CPU module status is changed from STOP to RUN, Extension parameter acquisition error (Warning code: 0B00H, 0B01H, 0B02H) occurs. At this time, the module extension parameter is the initial value set at the factory.
- The module parameter set with a program is overwritten with the parameter set in GX Works3 at power-on or when the CPU module status is changed from STOP to RUN. When the module parameter is not written to the CPU module, the setting value of the buffer memory is the factory default value at power-on and the value just before the status change is held when the CPU module status is changed from STOP to RUN.
- To use the module extension parameter set with a program after the power is turned off or the CPU module status is changed from STOP to RUN as well, backup the module extension parameter by using the module data backup function.

Parameter initialization

Initialize the parameter of the positioning module according to the methods as shown below.

○: Initialized, ×: Not initialized

Initialization method	Data type	Parameter to be initialized	
		Module parameter	Module extension parameter
<ul style="list-style-type: none"> Dedicated instruction GP.PINIT [Cd.2] Module data initialization request 	Buffer memory	○	○
	Parameter file ^{*1}	×	○

*1 The extension parameter storage setting determines whether the module extension parameter file stored in the CPU module is initialized or the module extension parameter file stored in the positioning module is initialized.

Precautions

When the module parameter is written to the CPU module, the written module parameter is reflected at power-on or when the CPU module status is changed from STOP to RUN. To cancel reflecting the parameter, delete the parameter from the CPU module or initialize the parameter with GX Works3.

Restrictions

When the extension parameter storage setting has been set to "CPU", the module data initialization can be performed only while the CPU module status is STOP. Use "[Cd.2] Module data initialization request" for the module data initialization.

Parameter backup

The module extension parameter in the buffer memory of the positioning module can be reflected to the module extension parameter file with the following methods.

Backup method	Parameter to be backed up	
	Module parameter	Module extension parameter ^{*1}
Dedicated instruction GP.PFWRT	×	○
[Cd.1] Module data backup request	×	○

*1 The extension parameter storage setting determines whether the module extension parameter file stored in the CPU module is backed up or the module extension parameter file stored in the positioning module is backed up.

■Restrictions

When the extension parameter storage setting has been set to "CPU", the module data backup can be performed only while the CPU module status is STOP. Use "[Cd.1] Module data backup request" for the module data backup.

18 PROGRAMMING

This chapter describes the program required for performing the positioning control with the positioning module. When creating a program required for the control, consider Start condition, Start time chart, Device setting, and the configuration of the whole control. (According to the control to be performed, set data such as parameters, positioning data, block start data, and condition data for the positioning module, and create a setting program of control data and a start program of each control.)

18.1 Precautions on Programming

This section describes common precautions for writing data of the CPU module to the buffer memory of the positioning module.

Reading/writing data

Using GX Works3 is recommended to set the data shown in this chapter (various parameters, positioning data, and block start data). Because setting the data with programs requires many programs and devices, the execution becomes complicated, and the scan times will increase. When changing positioning data during the continuous path control or continuous positioning control, rewrite the data before the positioning data four steps before is executed. If data has not been rewritten when the positioning data four steps before is executed, the data is processed as data that is not rewritten.

Restrictions on the execution interval of speed change

To change the speed successively using the speed change function or override function in the positioning module, set 10 ms or longer as the interval between each speed change.

Measures against an overrun

Setting [Pr. 12] Software stroke limit upper limit value and [Pr. 13] Software stroke limit lower limit value of detailed parameter 1 can prevent an overrun. Note that this is valid only when the positioning module is operating normally. Set limit switches to ensure the safety of the entire system. Establishing an external circuit through which the motor power turns off when a limit switch turns on is recommended.

System configuration

The following figure shows the system configuration used for the program examples in this section.

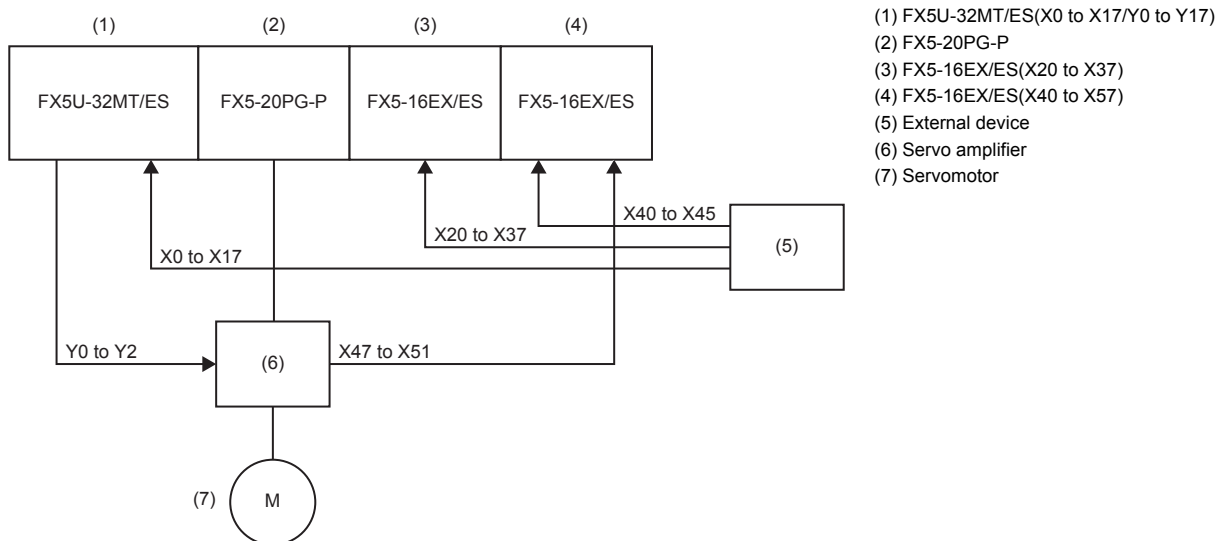

18.2 Creating Programs

This section describes Operation programs for the positioning control actually used.

Overall configuration of programs

The following table shows the overall configuration of positioning control operation programs.

No.	Program name	Remarks
1	Parameter setting program	<ul style="list-style-type: none"> The programs are unnecessary when parameters, positioning data, and block start data are set using GX Works3. When the machine OPR control is not performed, setting OPR parameters is unnecessary.
2	Positioning data setting program	
3	Block start data setting program	
4	OPR request OFF program	The program is unnecessary when the machine OPR is performed.
5	External command function valid setting program	—
6	PLC READY signal ([Cd.190] PLC READY signal) ON program	
7	Positioning start No. setting program	
8	Positioning start program	
9	Quick start program	The program is unnecessary when quick start is not performed.
10	M code OFF program	The program is unnecessary when the M code output function is not used.
11	JOG operation setting program	The program is unnecessary when the JOG operation is not used.
12	Inching operation setting program	The program is unnecessary when the inching operation is not used.
13	JOG operation/inching operation execution program	The program is unnecessary when the JOG operation and inching operation are not used.
14	Manual pulse generator operation program	The program is unnecessary when the manual pulse generator operation is not used.
15	Speed change program	The program is added as required.
16	Override program	
17	Acceleration/deceleration time change program	
18	Torque change program	
19	Step operation program	
20	Skip program	
21	Teaching program	
22	Continuous operation interrupt program	
23	Target position change program	
24	Absolute position restoration program	
25	Restart program	
26	Module initialization program	
27	Module backup program	
28	Error reset program	
29	Stop program	—

18.3 Example Positioning Program Using Labels

List of Labels Used

The following table lists the assignment of the labels to be used for the program examples in this section.

Module label	
Label Name	Description
■Positioning module input signal	
FX5PG_1.stSystemMonitorData2_D.bReady_D	READY ([Md.140] Module status: b0)
FX5PG_1.stSystemMonitorData2_D.bModuleAccessFlag_D	Module access flag ([Md.140] Module status: b1)
FX5PG_1.stnAxisMonitorData_Axis_D[0].bMcodeOn_D	Axis 1 M code ON signal ([Md.31] Status: b12)
FX5PG_1.stnAxisMonitorData_Axis_D[0].bErrorDetection_D	Axis 1 error detection signal ([Md.31] Status: b13)
FX5PG_1.stSystemMonitorData2_D.bnBusy_Axis_D[0]	Axis 1 BUSY signal ([Md.141] Module status: b0)
FX5PG_1.stnAxisMonitorData_Axis_D[0].bStartComplete_D	Axis 1 Start complete signal ([Md.31] Status: b14)
■Positioning module output signal	
FX5PG_1.bPLCReady_D	PLC READY signal ([Cd.190] PLC READY signal)
FX5PG_1.stnAxisControlData2_Axis_D[0].uAxisStop_D	Axis 1 Axis stop signal ([Cd.180] Axis stop signal)
FX5PG_1.stnAxisControlData2_Axis_D[0].bPositioningStart_D	Axis 1 Positioning start signal ([Cd.184] Positioning start signal)
■Buffer memory	
FX5PG_1.stnParameter_Axis_D[0].uUnitSetting_D	Axis 1 [Pr.1] Unit setting
FX5PG_1.stnParameter_Axis_D[0].uElectronicGearSelection_D	Axis 1 [Pr.62] Electronic gear selection
FX5PG_1.stnParameter_Axis_D[0].udPulsesPerRotation32bit_D	Axis 1 [Pr.2] No. of pulses per rotation (32 bits)
FX5PG_1.stnParameter_Axis_D[0].udMovementAmountPerRotation32bit_D	Axis 1 [Pr.3] Movement amount per rotation (32 bits)
FX5PG_1.stnParameter_Axis_D[0].uPulseOutputMode_D	Axis 1 [Pr.5] Pulse output mode
FX5PG_1.stnParameter_Axis_D[0].uRotationDirectionSetting_D	Axis 1 [Pr.6] Rotation direction setting
FX5PG_1.stnParameter_Axis_D[0].udBiasSpeed_D	Axis 1 [Pr.7] Bias speed at start
FX5PG_1.stnParameter_Axis_D[0].uPulsesPerRotation16bit_D	Axis 1 [Pr.2] No. of pulses per rotation (16 bits)
FX5PG_1.stnParameter_Axis_D[0].uMovementAmountPerRotation16bit_D	Axis 1 [Pr.3] Movement amount per rotation (16 bits)
FX5PG_1.stnParameter_Axis_D[0].uUnitMagnification_D	Axis 1 [Pr.4] Unit magnification
FX5PG_1.stnParameter_Axis_D[0].uOPR_Method_D	Axis 1 [Pr.43] OPR method
FX5PG_1.stnParameter_Axis_D[0].uOPR_Direction_D	Axis 1 [Pr.44] OPR direction
FX5PG_1.stnParameter_Axis_D[0].dOP_Address_D	Axis 1 [Pr.45] OP address
FX5PG_1.stnParameter_Axis_D[0].udOPR_Speed_D	Axis 1 [Pr.46] OPR speed
FX5PG_1.stnParameter_Axis_D[0].udCreepSpeed_D	Axis 1 [Pr.47] Creep speed
FX5PG_1.stnParameter_Axis_D[0].uOPR_Retry_D	Axis 1 [Pr.48] OPR retry
FX5PG_1.stnParameter_Axis_D[0].dSoftwareStrokeLimitUpperLimitValue_D	Axis 1 [Pr.12] Software stroke limit upper limit value
FX5PG_1.stnParameter_Axis_D[0].dSoftwareStrokeLimitLowerLimitValue_D	Axis 1 [Pr.13] Software stroke limit lower limit value
FX5PG_1.stnParameter_Axis_D[0].uCurrentFeedValue_SpeedControl_D	Axis 1 [Pr.21] Current feed value during speed control
FX5PG_1.stnParameter_Axis_D[0].uSpeedPositionFunctionSelection_D	Axis 1 [Pr.150] Speed-position function selection
FX5PG_1.stnAxisControlData_Axis_D[0].uOPR_RequestFlagOffRequest_D	Axis 1 [Cd.19] OPR request flag OFF request
FX5PG_1.stnAxisControlData_Axis_D[0].uExternalCommandValid_D	Axis 1 [Cd.8] External command valid
FX5PG_1.stnAxisControlData_Axis_D[0].uSpeedPositionSwitchingEnableFlag_D	Axis 1 [Cd.24] Speed-position switching enable flag
FX5PG_1.stnAxisControlData_Axis_D[0].udSpeedPositionSwitchingControlMovementAmountChangeRegister_D	Axis 1 [Cd.23] Speed-position switching control movement amount change register
FX5PG_1.stnAxisControlData_Axis_D[0].uPositionSpeedSwitchingControlEnableFlag_D	Axis 1 [Cd.26] Position-speed switching enable flag
FX5PG_1.stnAxisControlData_Axis_D[0].udPositionSpeedSwitchingControlSpeedChangeRegister_D	Axis 1 [Cd.25] Position-speed switching control speed change register
FX5PG_1.stnAxisControlData_Axis_D[0].uAnalysisModeSetting_D	Axis 1 [Cd.43] Analysis mode setting
FX5PG_1.stnAxisControlData_Axis_D[0].uMcodeOnSignalTurnsOffRequest_D	Axis 1 [Cd.7] M code ON signal OFF request
FX5PG_1.stnAxisControlData_Axis_D[0].uPositioningOperationSpeedOverride_D	Axis 1 [Cd.13] Positioning operation speed override
FX5PG_1.stnAxisControlData_Axis_D[0].uNewTorqueValue_D	Axis 1 [Cd.22] New torque value
FX5PG_1.stnAxisControlData_Axis_D[0].uStepMode_D	Axis 1 [Cd.34] Step mode

Label Name	Description
FX5PG_1.stnAxisControlData_Axis_D[0].uStepValidFlag_D	Axis 1 [Cd.35] Step valid flag
FX5PG_1.stnAxisControlData_Axis_D[0].uSkipCommand_D	Axis 1 [Cd.37] Skip command
FX5PG_1.stnAxisControlData_Axis_D[0].uInterruptionRequest_ContinuousOperation_D	Axis 1 [Cd.18] Continuous operation interrupt request
FX5PG_1.stnAxisMonitorData_Axis_D[0].uStatus_D.3	Axis 1 [Md.31] Status: OPR request flag
FX5PG_1.stnAxisMonitorData_Axis_D[0].uStatus_D.9	Axis 1 [Md.31] Status: Axis warning detection
FX5PG_1.stnAxisMonitorData_Axis_D[0].uAnalysisMode_D	Axis 1 [Md.60] Analysis mode

Global label

The following table lists the global labels used for the program examples in this section. Set the global labels as follows.

- Global labels for which Assign (Device/Label) is set

	Label Name	Data Type	Class	Assign (Device/Label)
1	blnInputOPRReqFlagOffReq	Bit	... VAR_GLOBAL	▼ X0
2	blnInputExternalCommandValidReq	Bit	... VAR_GLOBAL	▼ X1
3	blnInputExternalCommandInValidReq	Bit	... VAR_GLOBAL	▼ X2
4	blnInputOPRS startReq	Bit	... VAR_GLOBAL	▼ X3
5	uInputFastOPRS startReq	Bit	... VAR_GLOBAL	▼ X4
6	blnInputSetStartPositioningNoReq	Bit	... VAR_GLOBAL	▼ X5
7	blnInputSpeedPositionSwitchingReq	Bit	... VAR_GLOBAL	▼ X6
8	blnInputSpeedPositionSwitchingEnableReq	Bit	... VAR_GLOBAL	▼ X7
9	blnInputSpeedPositionSwitchingDisableReq	Bit	... VAR_GLOBAL	▼ X10
10	blnInputChangeSpeedPositionSwitchingMovementAmount	Bit	... VAR_GLOBAL	▼ X11
11	blnInputStartAdvancedPositioningReq	Bit	... VAR_GLOBAL	▼ X12
12	blnInputStartPositioningReq	Bit	... VAR_GLOBAL	▼ X13
13	blnInputModeOffReq	Bit	... VAR_GLOBAL	▼ X14
14	blnInputSetJogSpeedReq	Bit	... VAR_GLOBAL	▼ X15
15	blnInputForwardJogStartReq	Bit	... VAR_GLOBAL	▼ X16
16	blnInputReverseJogStartReq	Bit	... VAR_GLOBAL	▼ X17
17	blnInputStartMPGReq	Bit	... VAR_GLOBAL	▼ X20
18	blnInputCurrentFeedValueChangeReq	Bit	... VAR_GLOBAL	▼ X21
19	blnInputChangeSpeedReq	Bit	... VAR_GLOBAL	▼ X22
20	blnInputOverrideReq	Bit	... VAR_GLOBAL	▼ X23
21	blnInputChangeAccDecTimeReq	Bit	... VAR_GLOBAL	▼ X24
22	blnInputChangeAccDecTimeDisable	Bit	... VAR_GLOBAL	▼ X25
23	blnInputChangeTorqueReq	Bit	... VAR_GLOBAL	▼ X26
24	blnInputStepOperationReq	Bit	... VAR_GLOBAL	▼ X27
25	blnInputSkipReq	Bit	... VAR_GLOBAL	▼ X30
26	blnInputTeachingReq	Bit	... VAR_GLOBAL	▼ X31
27	blnInputStopContinuousOperationReq	Bit	... VAR_GLOBAL	▼ X32
28	blnInputRestartReq	Bit	... VAR_GLOBAL	▼ X33
29	blnInputInitializeParameterReq	Bit	... VAR_GLOBAL	▼ X34
30	blnInputWriteFlashReq	Bit	... VAR_GLOBAL	▼ X35
31	blnInputErrResetReq	Bit	... VAR_GLOBAL	▼ X36
32	blnInputStopReq	Bit	... VAR_GLOBAL	▼ X37
33	blnInputPositionSpeedSwitchingReq	Bit	... VAR_GLOBAL	▼ X40
34	blnInputPositionSpeedSwitchingEnableReq	Bit	... VAR_GLOBAL	▼ X41
35	blnInputPositionSpeedSwitchingDisableReq	Bit	... VAR_GLOBAL	▼ X42
36	blnInputChangePositionSpeedSwitchingSpeedReq	Bit	... VAR_GLOBAL	▼ X43
37	blnInputSetInchingMovementAmountReq	Bit	... VAR_GLOBAL	▼ X44
38	blnInputTargetPositionChangeReq	Bit	... VAR_GLOBAL	▼ X45
39	blnInputAbsBit0	Bit	... VAR_GLOBAL	▼ X47
40	blnInputAbsBit1	Bit	... VAR_GLOBAL	▼ X50
41	blnInputTrDataComp	Bit	... VAR_GLOBAL	▼ X51
42	blnInputPreReadingStartReq	Bit	... VAR_GLOBAL	▼ X53
43	blnInputExecutionProhibitionFlagReleaseReq	Bit	... VAR_GLOBAL	▼ X54
44	blnInputSpeedPositionSwitchingAbsSetReq	Bit	... VAR_GLOBAL	▼ X55
45	blnInputBErrResetReq	Bit	... VAR_GLOBAL	▼ X56
46	blnInputFastStartReq	Bit	... VAR_GLOBAL	▼ X57
47	bOutputServoON	Bit	... VAR_GLOBAL	▼ Y0
48	bOutputAbsTrMode	Bit	... VAR_GLOBAL	▼ Y1
49	bOutputAbsReq	Bit	... VAR_GLOBAL	▼ Y2

- Global labels for which Assign (Device/Label) is not set (When Assign (Device/Label) is not set, the unused internal relay and data device are automatically assigned.)

	Label Name	Data Type	Class	Assign (Device/Label)
1	bSetPositioningData_bEN	Bit	VAR_GLOBAL	▼
2	bSetPositioningData_bENO	Bit	VAR_GLOBAL	▼
3	bSetPositioningData_bOK	Bit	VAR_GLOBAL	▼
4	bSetPositioningData_bErr	Bit	VAR_GLOBAL	▼
5	uSetPositioningData_uErrId	Word [Unsigned]/Bit String [16-bit]	VAR_GLOBAL	▼
6	bJOG_bENO	Bit	VAR_GLOBAL	▼
7	bJOG_bOK	Bit	VAR_GLOBAL	▼
8	bJOG_bErr	Bit	VAR_GLOBAL	▼
9	uJOG_uErrId	Word [Unsigned]/Bit String [16-bit]	VAR_GLOBAL	▼
10	bMPG_bENO	Bit	VAR_GLOBAL	▼
11	bMPG_bOK	Bit	VAR_GLOBAL	▼
12	bMPG_bErr	Bit	VAR_GLOBAL	▼
13	uMPG_uErrId	Word [Unsigned]/Bit String [16-bit]	VAR_GLOBAL	▼
14	bChangeSpeed_bENO	Bit	VAR_GLOBAL	▼
15	bChangeSpeed_bOK	Bit	VAR_GLOBAL	▼
16	bChangeSpeed_bErr	Bit	VAR_GLOBAL	▼
17	uChangeSpeed_uErrId	Word [Unsigned]/Bit String [16-bit]	VAR_GLOBAL	▼
18	bChangeAccDecTime_bENO	Bit	VAR_GLOBAL	▼
19	bChangeAccDecTime_bOK	Bit	VAR_GLOBAL	▼
20	bChangeAccDecTime_bErr	Bit	VAR_GLOBAL	▼
21	uChangeAccDecTime_uErrId	Word [Unsigned]/Bit String [16-bit]	VAR_GLOBAL	▼
22	bChangePosition_bENO	Bit	VAR_GLOBAL	▼
23	bChangePosition_bOK	Bit	VAR_GLOBAL	▼
24	bChangePosition_bErr	Bit	VAR_GLOBAL	▼
25	uChangePosition_uErrId	Word [Unsigned]/Bit String [16-bit]	VAR_GLOBAL	▼
26	bRestart_bENO	Bit	VAR_GLOBAL	▼
27	bRestart_bOK	Bit	VAR_GLOBAL	▼
28	bRestart_bErr	Bit	VAR_GLOBAL	▼
29	uRestart_uErrId	Word [Unsigned]/Bit String [16-bit]	VAR_GLOBAL	▼
30	bInitializeParameter_bENO	Bit	VAR_GLOBAL	▼
31	bInitializeParameter_bOK	Bit	VAR_GLOBAL	▼
32	bInitializeParameter_bErr	Bit	VAR_GLOBAL	▼
33	uInitializeParameter_uErrId	Word [Unsigned]/Bit String [16-bit]	VAR_GLOBAL	▼
34	bOperateError_bENO	Bit	VAR_GLOBAL	▼
35	bOperateError_bOK	Bit	VAR_GLOBAL	▼
36	bOperateError_bModuleErr	Bit	VAR_GLOBAL	▼
37	uOperateError_uModuleErrId	Word [Unsigned]/Bit String [16-bit]	VAR_GLOBAL	▼
38	bOperateError_bModuleWarn	Bit	VAR_GLOBAL	▼
39	uOperateError_uModuleWarnId	Word [Unsigned]/Bit String [16-bit]	VAR_GLOBAL	▼
40	bOperateError_bErr	Bit	VAR_GLOBAL	▼
41	uOperateError_uErrId	Word [Unsigned]/Bit String [16-bit]	VAR_GLOBAL	▼
42	bWriteFlash_bENO	Bit	VAR_GLOBAL	▼
43	bWriteFlash_bOK	Bit	VAR_GLOBAL	▼
44	bWriteFlash_bErr	Bit	VAR_GLOBAL	▼
45	uWriteFlash_uErrId	Word [Unsigned]/Bit String [16-bit]	VAR_GLOBAL	▼
46	bBasicParamSetComp	Bit	VAR_GLOBAL	▼
47	bSetElectronicGear16bit	Bit	VAR_GLOBAL	▼
48	bOPRPParamSetComp	Bit	VAR_GLOBAL	▼
49	uBlockData	Word [Unsigned]/Bit String [16-bit](0.4)	VAR_GLOBAL	▼
50	uBlockInstData	Word [Unsigned]/Bit String [16-bit](0.4)	VAR_GLOBAL	▼
51	bOPRReqFlagOfrReq_P	Bit	VAR_GLOBAL	▼
52	bOPRReqFlagOfrReq_H	Bit	VAR_GLOBAL	▼
53	bOPRReqFlagOfrReq	Bit	VAR_GLOBAL	▼
54	udMovementAmount	Double Word [Unsigned]/Bit String [32-bit]	VAR_GLOBAL	▼
55	udSpeed	Double Word [Signed]	VAR_GLOBAL	▼
56	bStartPositioning_bENO	Bit	VAR_GLOBAL	▼
57	bStartPositioning_bOK	Bit	VAR_GLOBAL	▼
58	bStartPositioning_bErr	Bit	VAR_GLOBAL	▼
59	uStartPositioning_uErrId	Word [Unsigned]/Bit String [16-bit]	VAR_GLOBAL	▼
60	bDuringMPGOperation	Bit	VAR_GLOBAL	▼
61	bFastStartPreparationComp	Bit	VAR_GLOBAL	▼
62	bFastOPRS_startReq	Bit	VAR_GLOBAL	▼
63	bFastOPRS_startReq_H	Bit	VAR_GLOBAL	▼
64	bDuringJogInchingOperation	Bit	VAR_GLOBAL	▼
65	udJogOperationSpeed	Double Word [Unsigned]/Bit String [32-bit]	VAR_GLOBAL	▼
66	uInchingMovementAmount	Word [Unsigned]/Bit String [16-bit]	VAR_GLOBAL	▼
67	bChangeSpeedReq	Bit	VAR_GLOBAL	▼
68	bOverrideReq_P	Bit	VAR_GLOBAL	▼
69	bChangeAccDecTime_Enabled	Bit	VAR_GLOBAL	▼
70	bStepOperationReq_P	Bit	VAR_GLOBAL	▼
71	bChangeTorqueReq	Bit	VAR_GLOBAL	▼
72	bSkipReq_P	Bit	VAR_GLOBAL	▼
73	bSkipReq	Bit	VAR_GLOBAL	▼
74	bTeachingReq_P	Bit	VAR_GLOBAL	▼
75	bTeachingReq	Bit	VAR_GLOBAL	▼
76	uTeachingData	Word [Unsigned]/Bit String [16-bit](0.3)	VAR_GLOBAL	▼
77	uTeachingDevice	Bit(0.1)	VAR_GLOBAL	▼
78	bStopContinuousOperationReq_P	Bit	VAR_GLOBAL	▼
79	bTargetPositionChangeReq	Bit	VAR_GLOBAL	▼
80	bRestartReq	Bit	VAR_GLOBAL	▼
81	bInitializeParameterReq	Bit	VAR_GLOBAL	▼
82	bWriteFlashReq	Bit	VAR_GLOBAL	▼
83	bErrResetReq	Bit	VAR_GLOBAL	▼
84	bStopReq_P	Bit	VAR_GLOBAL	▼
85	bABRS_TReq	Bit	VAR_GLOBAL	▼
86	bErrReadReq	Bit	VAR_GLOBAL	▼
87	bPositioningStartReq	Bit	VAR_GLOBAL	▼
88	bABRS_TReq_P	Bit	VAR_GLOBAL	▼
89	bABRS_T_bENO	Bit	VAR_GLOBAL	▼
90	bABRS_T_bOK	Bit	VAR_GLOBAL	▼
91	bABRS_T_bAbsNG	Bit	VAR_GLOBAL	▼
92	uABRS_T_uAbsErrId	Word [Unsigned]/Bit String [16-bit]	VAR_GLOBAL	▼
93	bABRS_T_bErr	Bit	VAR_GLOBAL	▼
94	uABRS_T_uErrId	Word [Unsigned]/Bit String [16-bit]	VAR_GLOBAL	▼
95	uPositioningStartNo	Word [Signed]	VAR_GLOBAL	▼
96	bInputInterruptMaskRstReq	Bit	VAR_GLOBAL	▼
97	bSkipFunctionSelectionReq	Bit	VAR_GLOBAL	▼

Program example

This section shows program examples for positioning of Axis 1.

Parameter setting program

When parameters are set using "Module Parameter" in GX Works3, this program is unnecessary.

Setting of basic parameter 1 (axis 1)

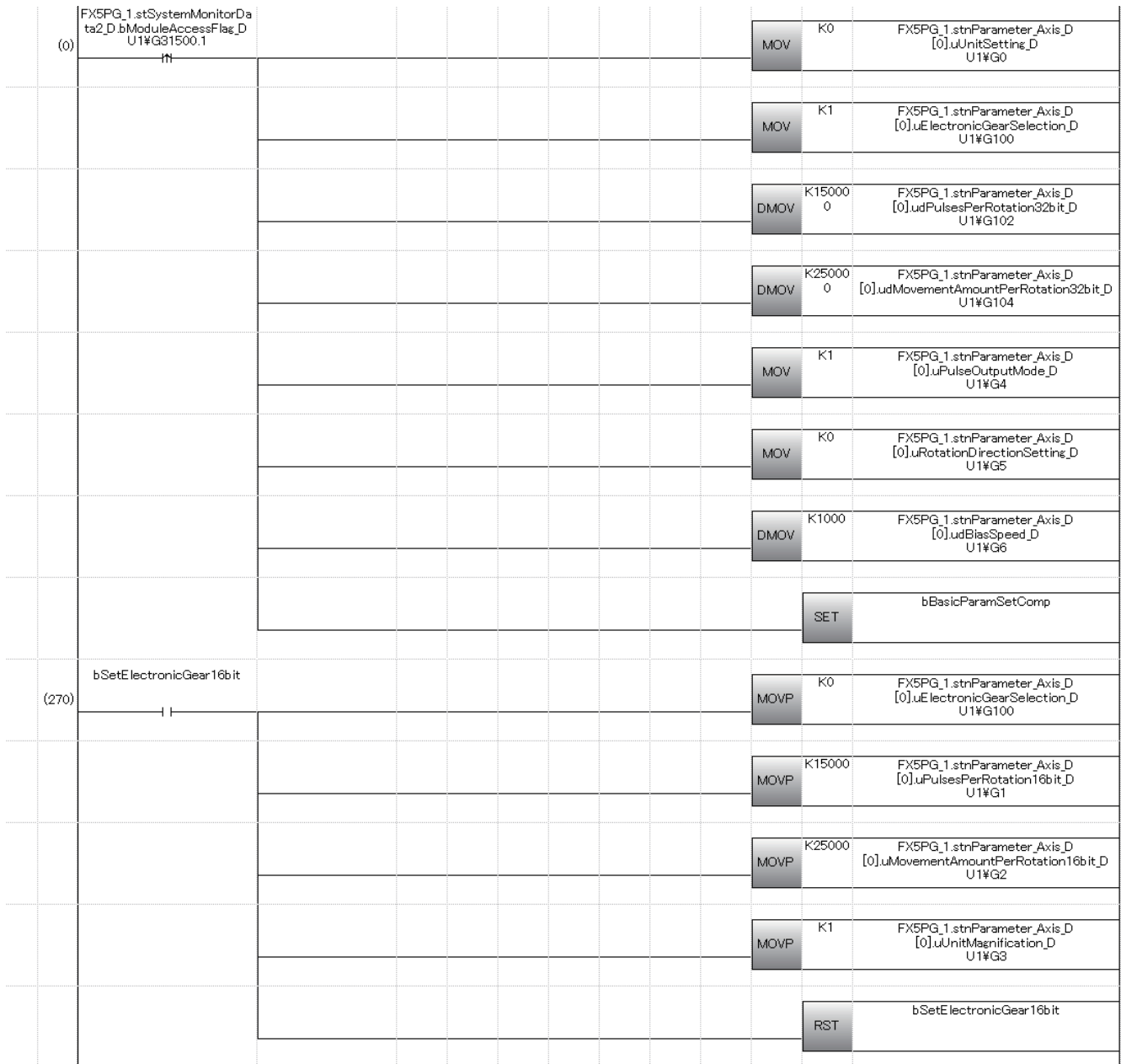

(270) For using the electronic gear function in 16 bits

■Setting of OPR basic parameter (axis 1)

(395)	FX5PG_1.stSystemMonitorData2_D.bModuleAccessFlag_D U1#G31500.1	MOV	K0	FX5PG_1.stnParameter_Axis_D [0].uOPR_Method_D U1#G70
		MOV	K0	FX5PG_1.stnParameter_Axis_D [0].uOPR_Direction_D U1#G71
		DMOV	K0	FX5PG_1.stnParameter_Axis_D [0].dOP_Address_D U1#G72
		DMOV	K5000	FX5PG_1.stnParameter_Axis_D [0].udOPR_Speed_D U1#G74
		DMOV	K1500	FX5PG_1.stnParameter_Axis_D [0].udCreepSpeed_D U1#G76
		MOV	K1	FX5PG_1.stnParameter_Axis_D [0].uOPR_Retry_D U1#G78
		SET		bOPRParamSetComp

■Parameter setting program for the speed-position switching control (ABS mode)

This program is unnecessary when the speed-position switching control (ABS mode) is not executed.

(628)	FX5PG_1.stSystemMonitorData2_D.bModuleAccessFlag_D U1#G31500.1	bInputSpeedPositionSwitchingAbsSetReq X55	MOV P	K2	FX5PG_1.stnParameter_Axis_D [0].uUnitSetting_D U1#G0
			DMOV P	K0	FX5PG_1.stnParameter_Axis_D [0].dSoftwareStrokeLimitUpperLimitValue_D U1#G18
			DMOV P	K0	FX5PG_1.stnParameter_Axis_D [0].dSoftwareStrokeLimitLowerLimitValue_D U1#G20
			MOV P	K1	FX5PG_1.stnParameter_Axis_D [0].uCurrentFeedValue_SpeedControl_D U1#G30
			MOV P	K2	FX5PG_1.stnParameter_Axis_D [0].uSpeedPositionFunctionSelection_D U1#G34

Block start data setting program

When positioning data is set using "Module Extended Parameter" in GX Works3, this program is unnecessary.

(0)	FX5PG_1.stSystemMonitorDat a2_D_bModuleAccessFlag_D U1#G31500.1				MOV	H8001	uBlockData[0]
					MOV	H8002	uBlockData[1]
					MOV	H8005	uBlockData[2]
					MOV	H800A	uBlockData[3]
				MOV	H0F	uBlockData[4]	
				TO	FX5PG_1.uIO H1	K26000	uBlockData[0] K5
(327)	FX5PG_1.stSystemMonitorDat a2_D_bModuleAccessFlag_D U1#G31500.1				MOV	H0	uBlockInstData[0]
					MOV	H0	uBlockInstData[1]
					MOV	H0	uBlockInstData[2]
					MOV	H0	uBlockInstData[3]
				MOV	H0	uBlockInstData[4]	
				TO	FX5PG_1.uIO H1	K26050	uBlockInstData[0] K5

OPR request OFF program

When "Setting of operation during uncompleted OPR" is set to "1: Execute positioning control" in "Module Parameter" of GX Works3, this program is unnecessary.

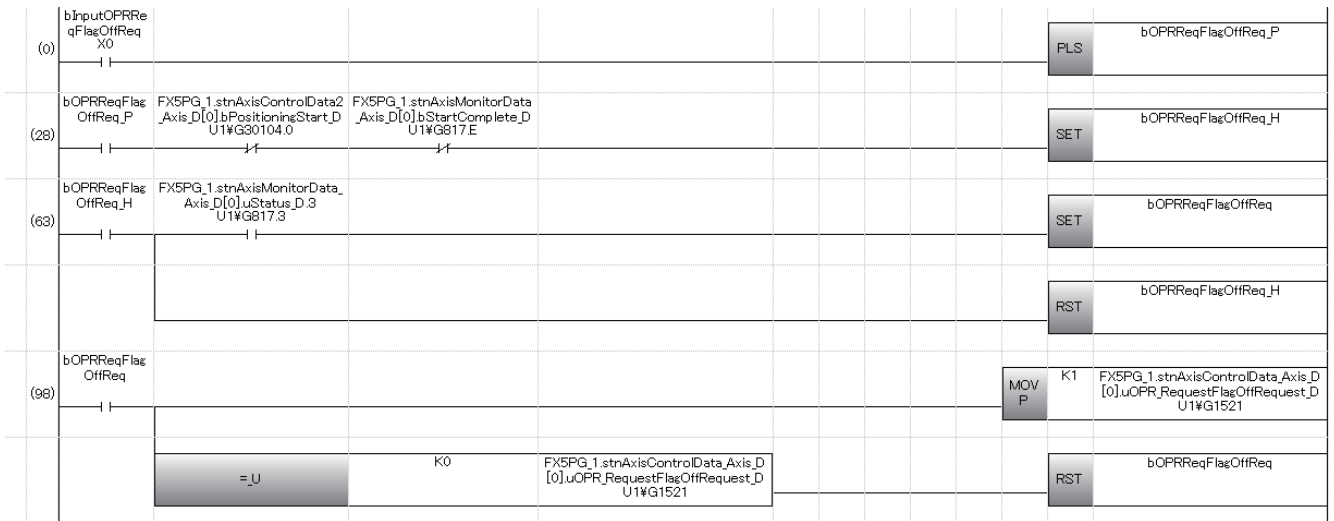

External command function valid setting program



[Cd.190] PLC READY signal ON program

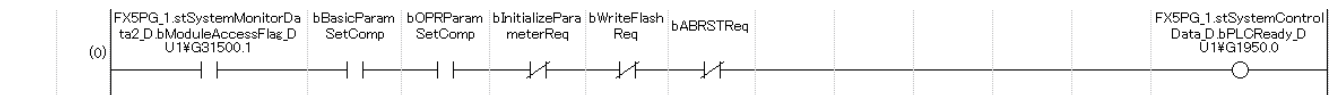

Positioning start No. setting program

Machine OPR



Fast OPR

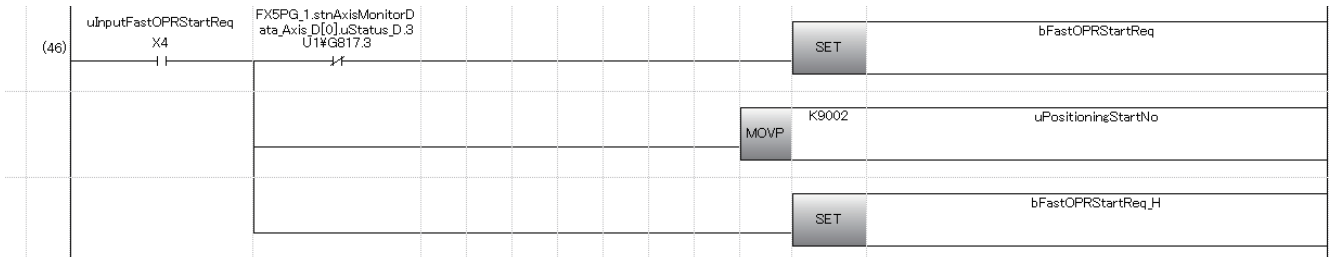

■Positioning with the positioning data No.1

(137)	bInputSetStartPositioningNoReq X5	MOVP	K1	uPositioningStartNo
-------	-----------------------------------	------	----	---------------------

■Speed-position switching control (positioning data No.2)

For the ABS mode, writing the target movement amount after change is unnecessary.

(194)	bInputSpeedPositionSwitchingReq X6	MOVP	K2	uPositioningStartNo
(285)	bInputSpeedPositionSwitchingEnableReq X7	MOVP	K1	FX5PG_1.stnAxisControlData_Axis_D [0].uPositionSpeedSwitchingControlEnableFlag_D U1#G1532
(315)	bInputSpeedPositionSwitchingDisableReq X10	MOVP	K0	FX5PG_1.stnAxisControlData_Axis_D [0].uSpeedPositionSwitchingControlEnableFlag_D U1#G1528
(345)	bInputChangeSpeedPositionSwitchingMovementAmount X11	DMOV P	udMovementAmount	FX5PG_1.stnAxisControlData_Axis_D [0].udSpeedPositionSwitchingControlMovementAmountChangeRegister_D U1#G1526

■Position-speed switching control (positioning data No.3)

(371)	bInputPositionSpeedSwitchingReq X40	MOVP	K3	uPositioningStartNo
(433)	bInputPositionSpeedSwitchingEnableReq X41	MOVP	K1	FX5PG_1.stnAxisControlData_Axis_D [0].uPositionSpeedSwitchingControlEnableFlag_D U1#G1532
(463)	bInputPositionSpeedSwitchingDisableReq X42	MOVP	K0	FX5PG_1.stnAxisControlData_Axis_D [0].uPositionSpeedSwitchingControlEnableFlag_D U1#G1532
(493)	bInputChangePositionSpeedSwitchingSpeedReq X43	DMOV P	udSpeed	FX5PG_1.stnAxisControlData_Axis_D [0].udPositionSpeedSwitchingControlSpeedChangeRegister_D U1#G1530

■Advanced positioning control

(518)	bInputStartAdvancedPositioningReq X12	MOVP	K7000	uPositioningStartNo
-------	---------------------------------------	------	-------	---------------------

■Turning off a fast OPR command and fast OPR command storage

This program is unnecessary when the fast OPR is not used.

(569)	bInputOPRStartReq X3	RST		bFastOPRStartReq
	bInputSetStartPositioningNoReq X5	RST		bFastOPRStartReq_H
	bInputSpeedPositionSwitchingReq X6			
	bInputPositionSpeedSwitchingReq X40			
	bInputStartAdvancedPositioningReq X12			
	bPositioningStartReq			

Positioning start program

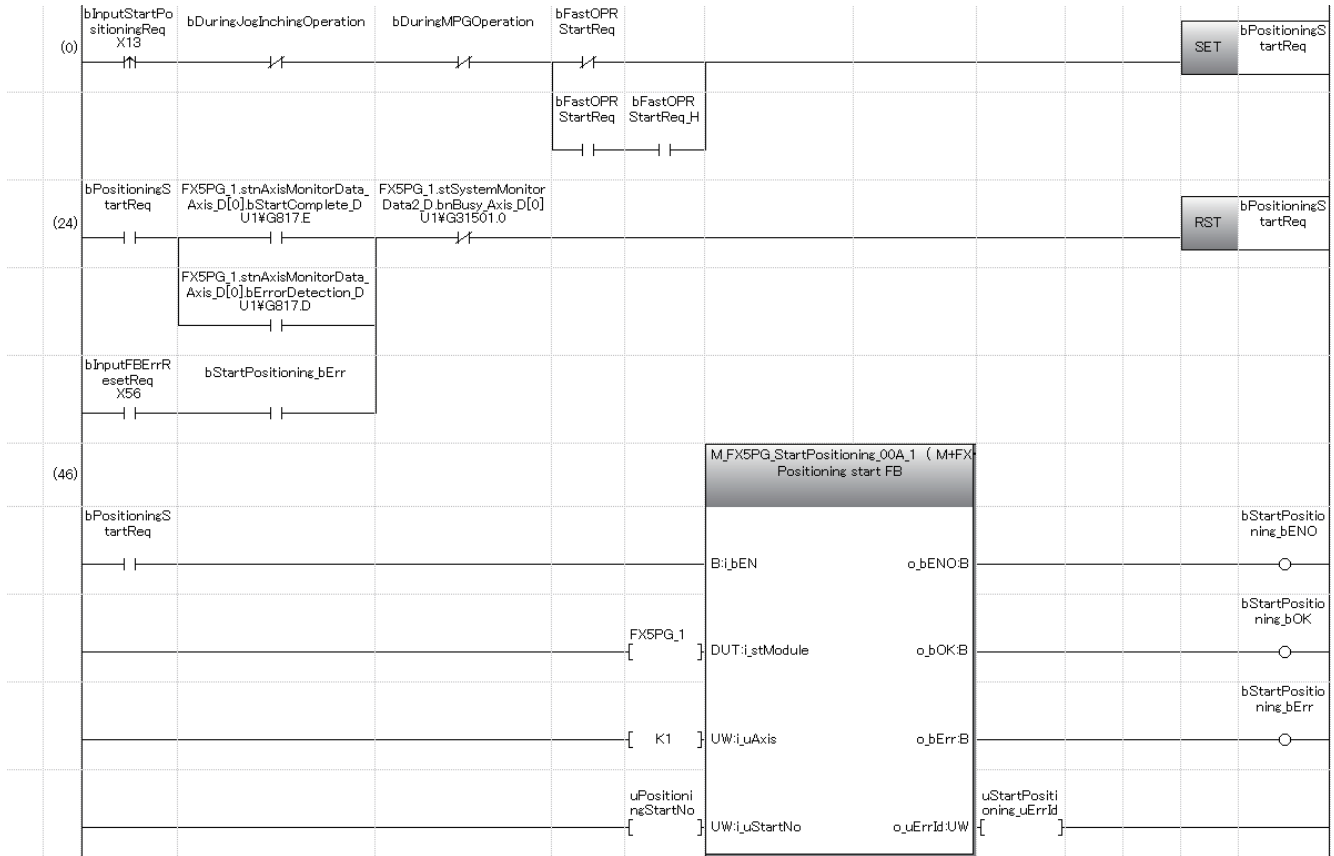

Quick start program

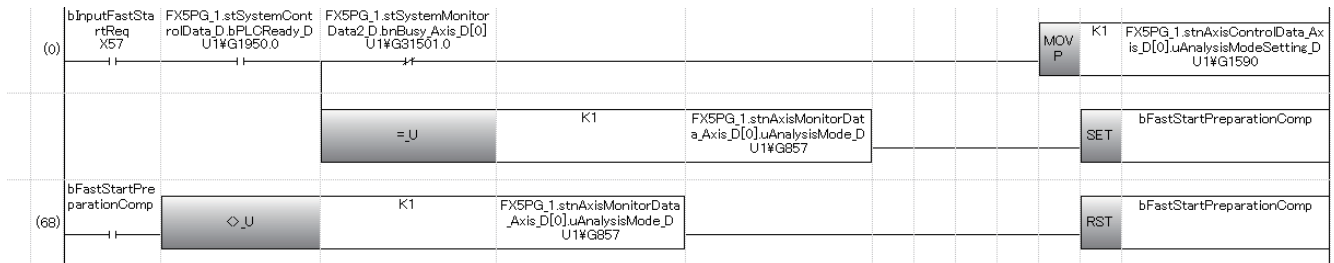

M code OFF program



JOG operation setting program

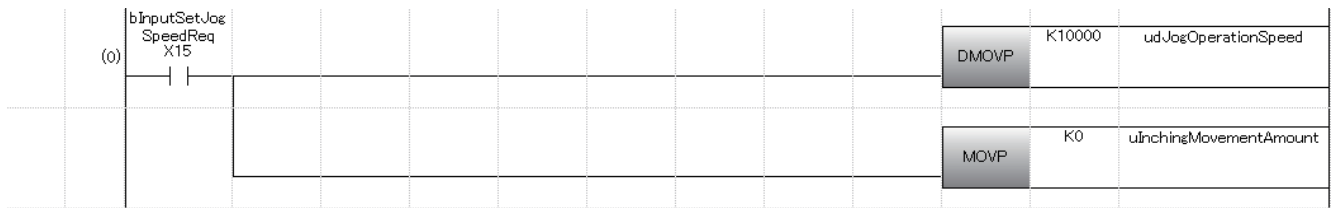

Inching operation setting program



JOG operation/inching operation execution program

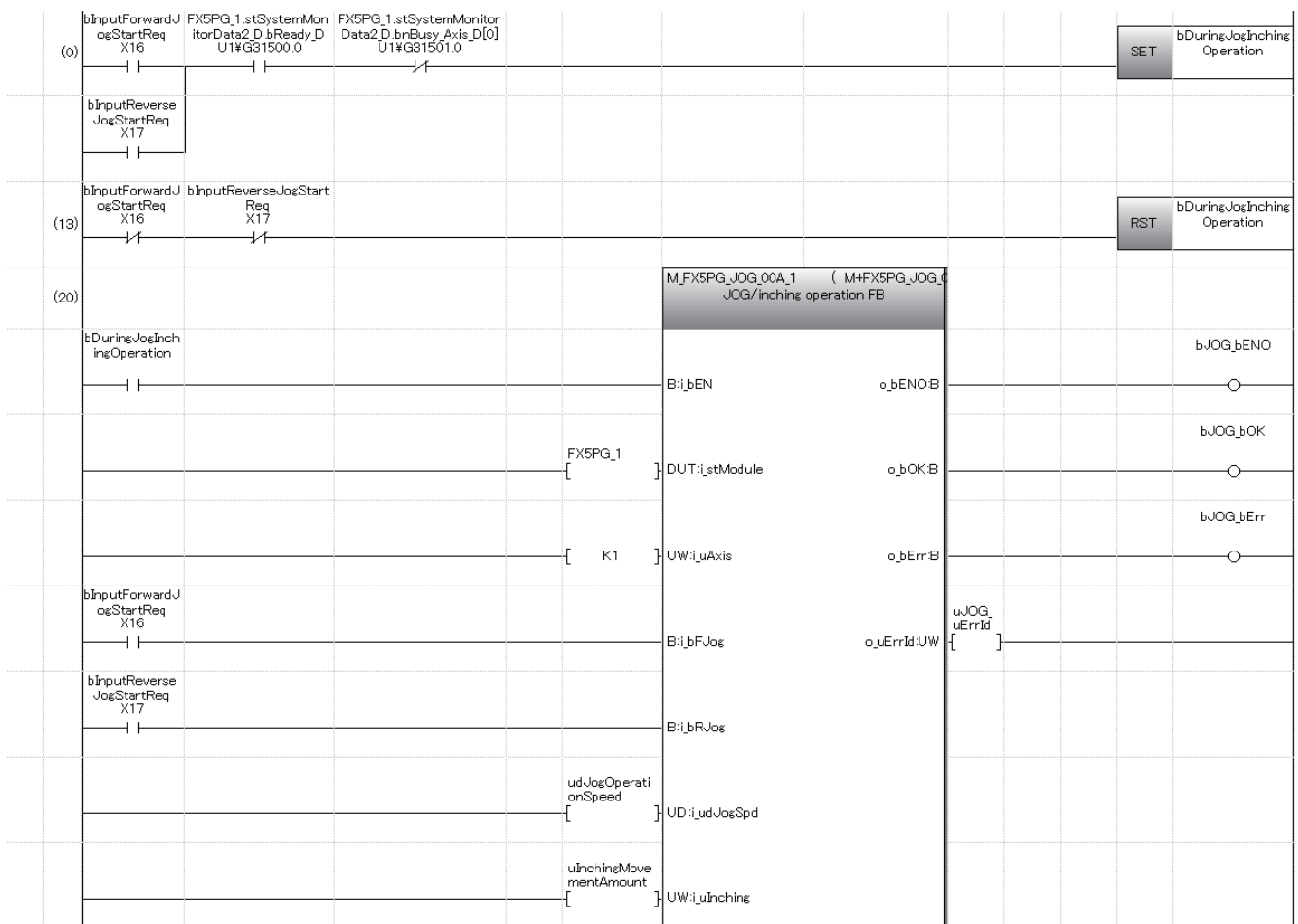

Manual pulse generator operation program

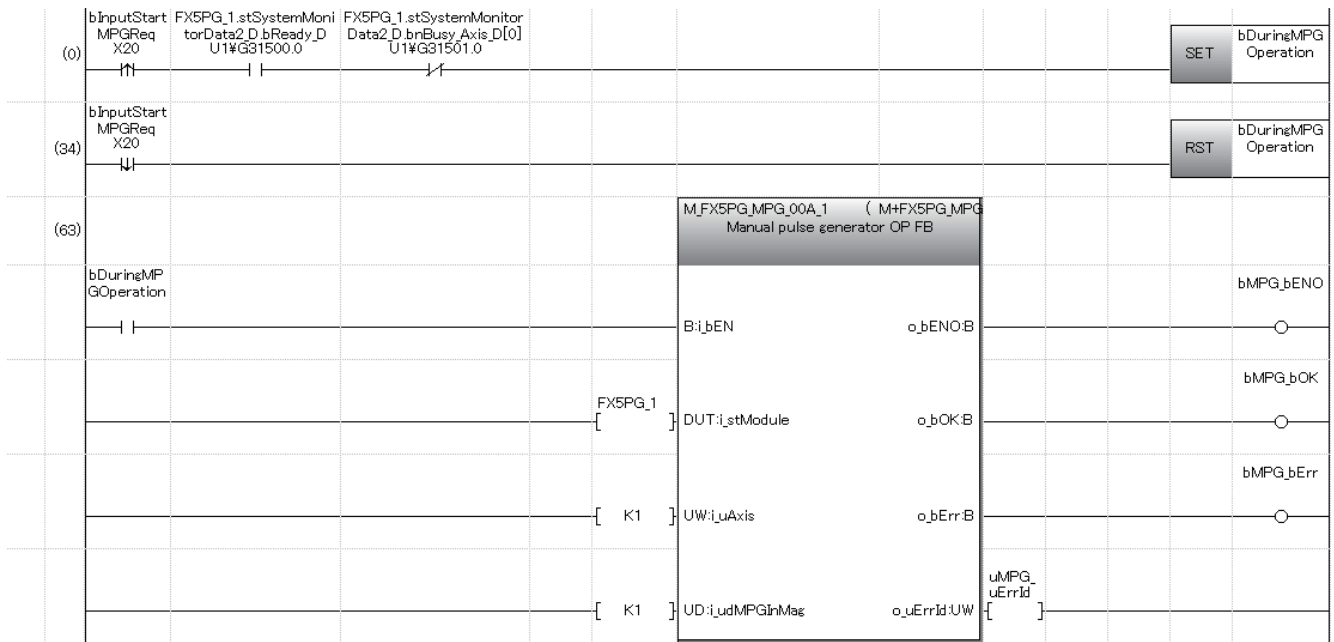

Speed change program

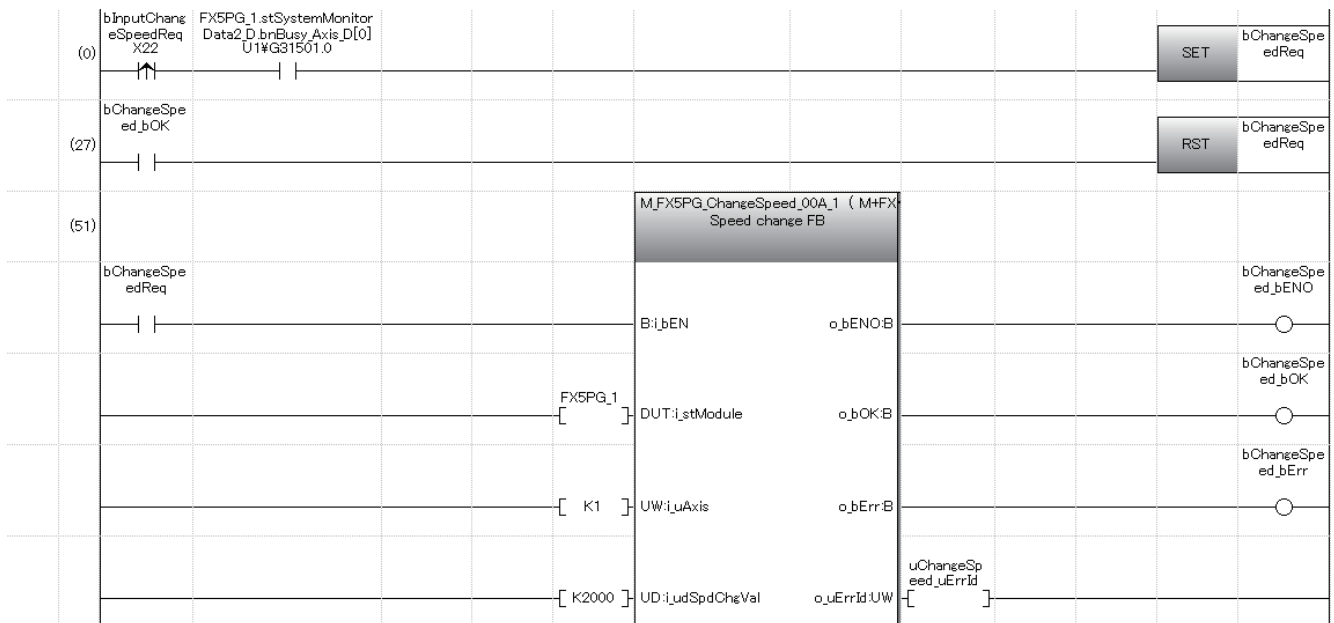

Override program



Acceleration/deceleration time change program

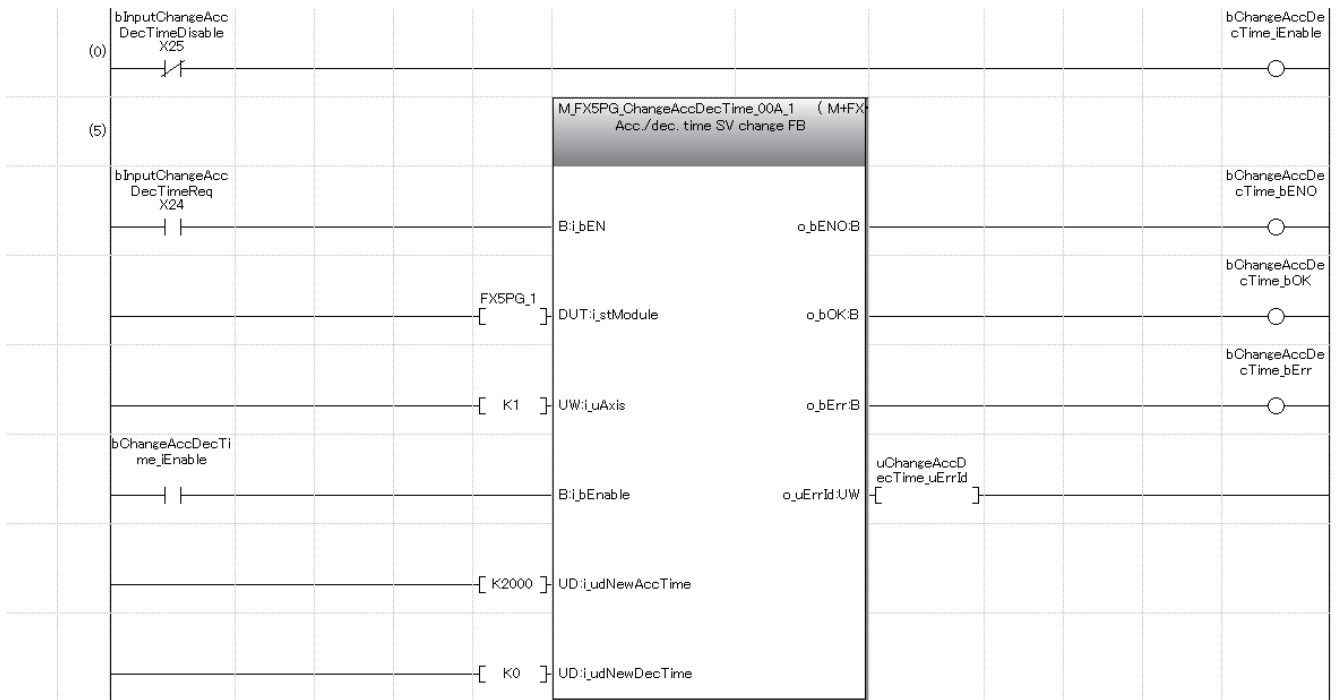

Torque change program



Step operation program

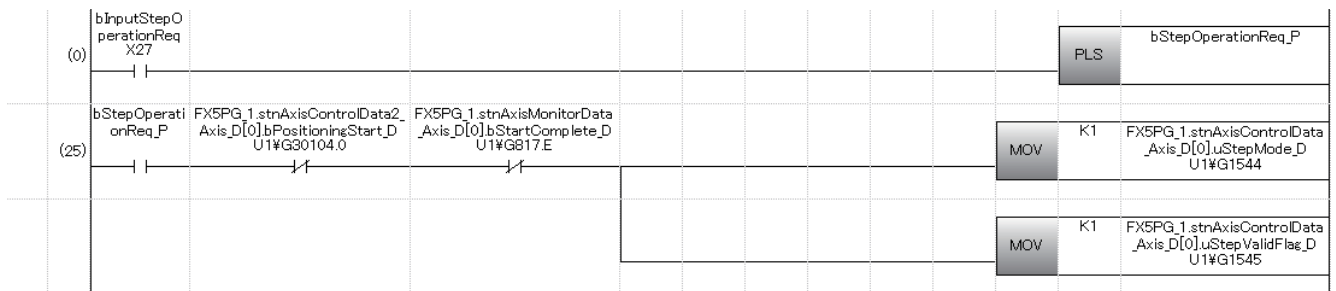

Skip program

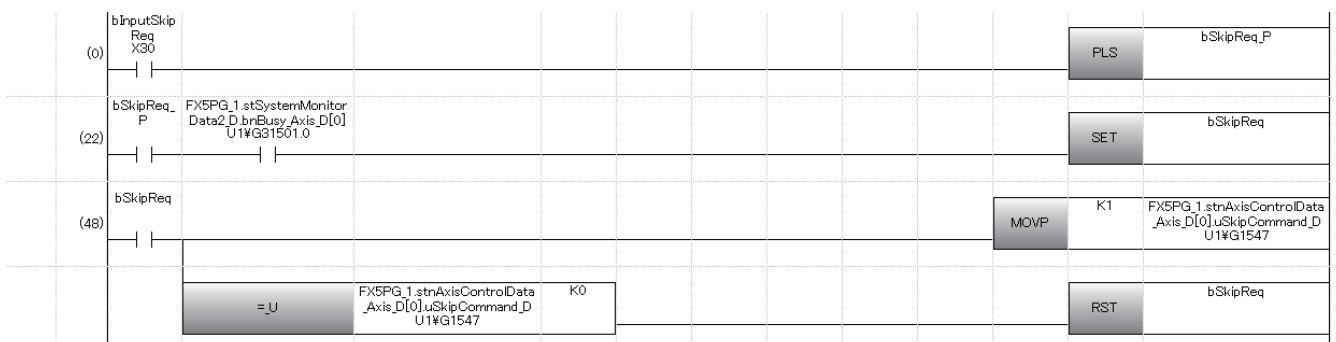

Teaching program



Continuous operation interrupt program

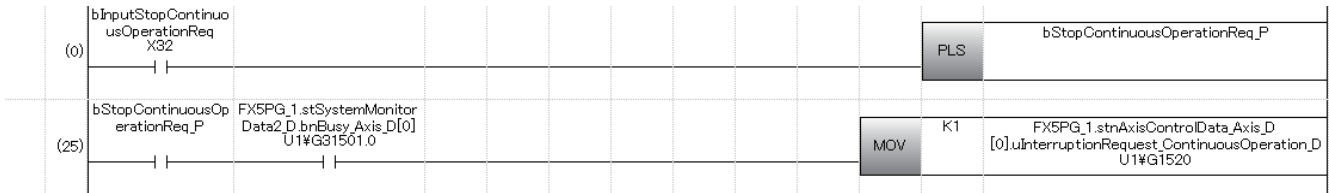

Target position change program

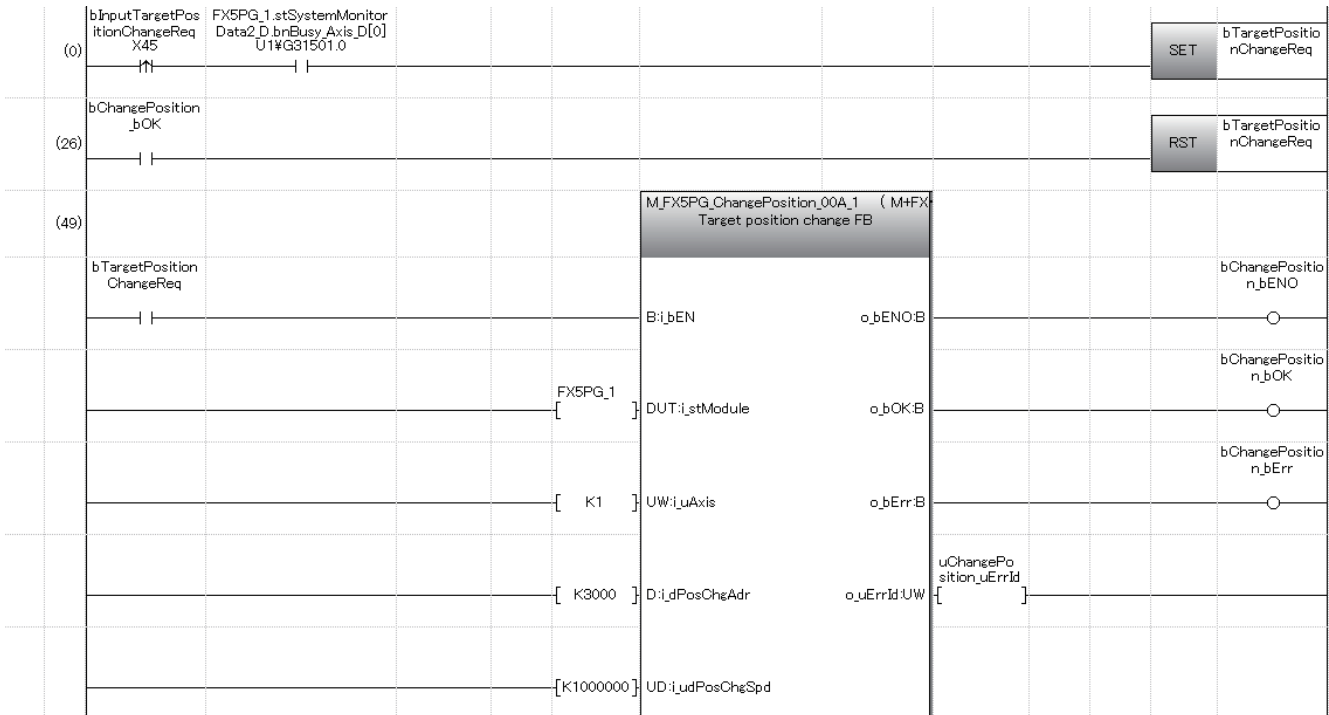

Absolute position restoration program

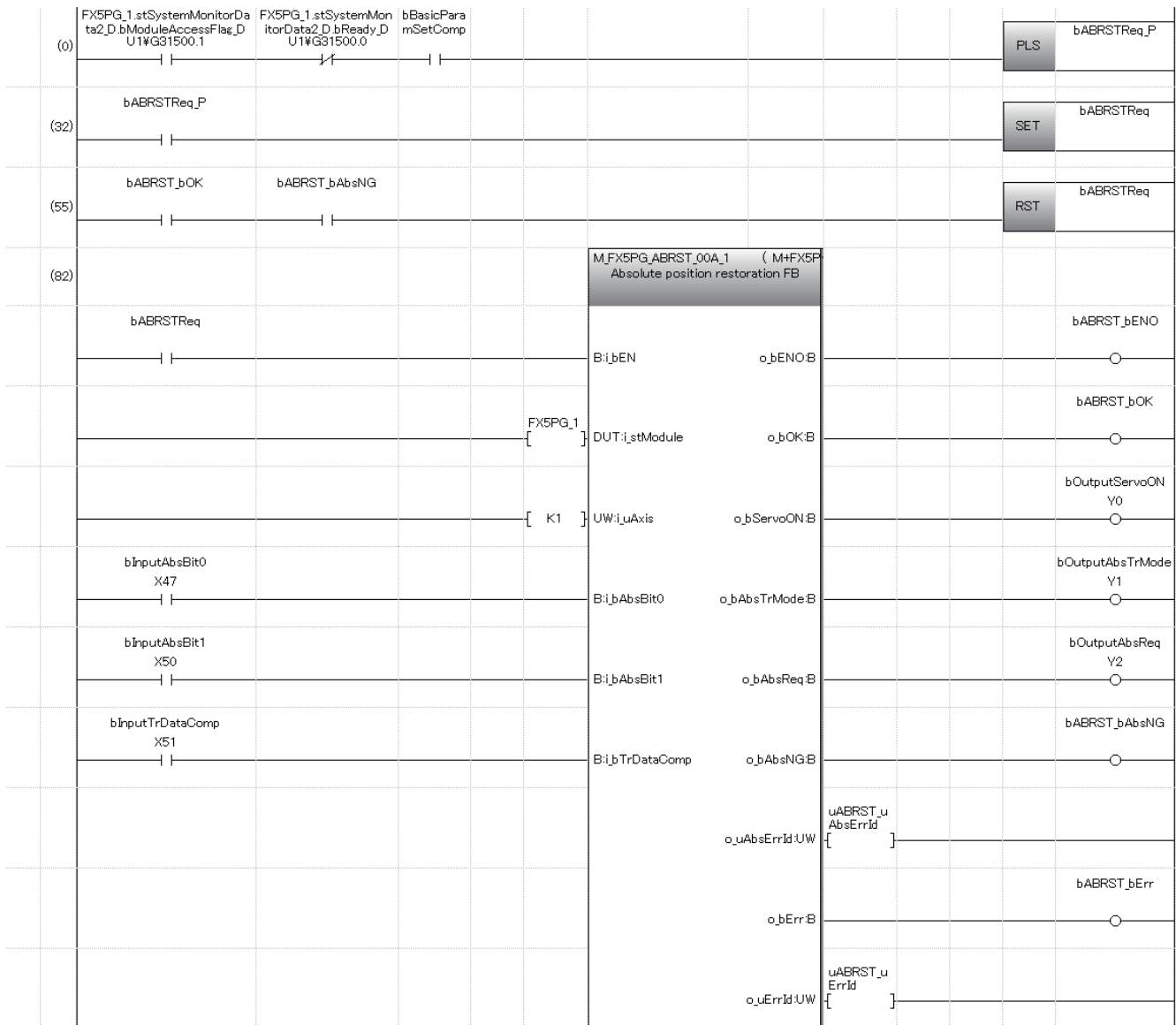

Restart program

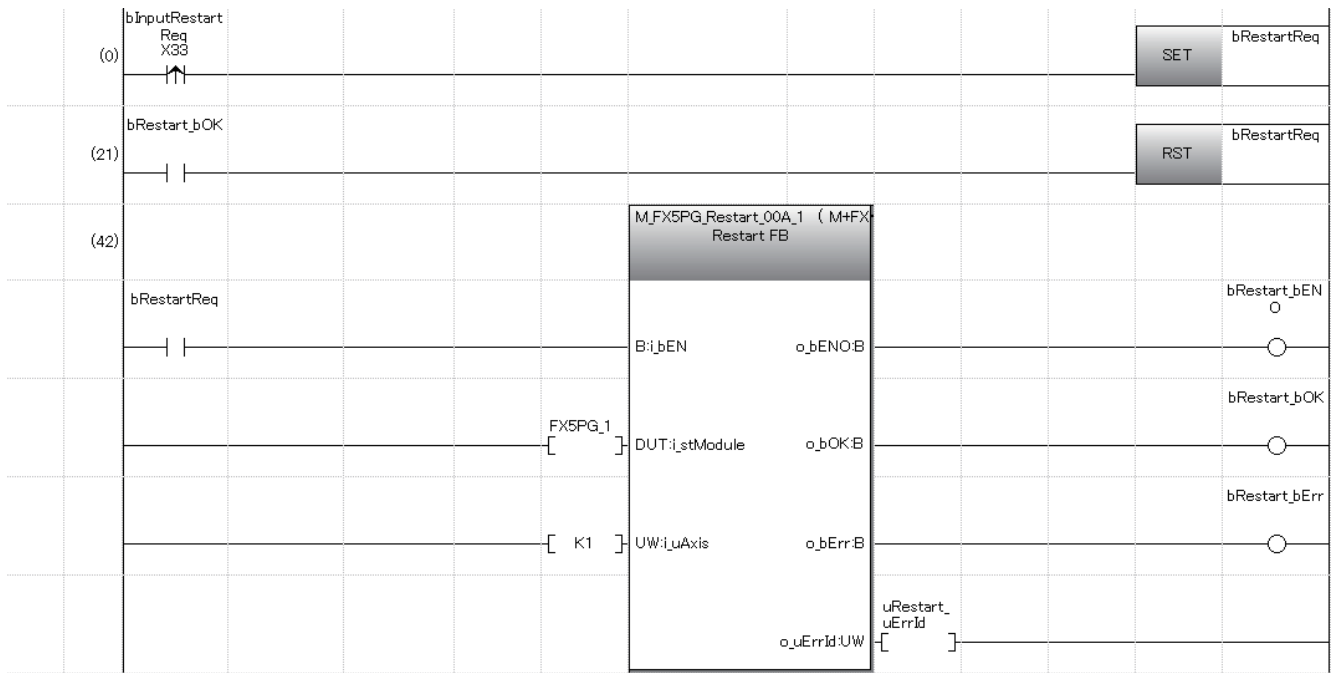

Module initialization program

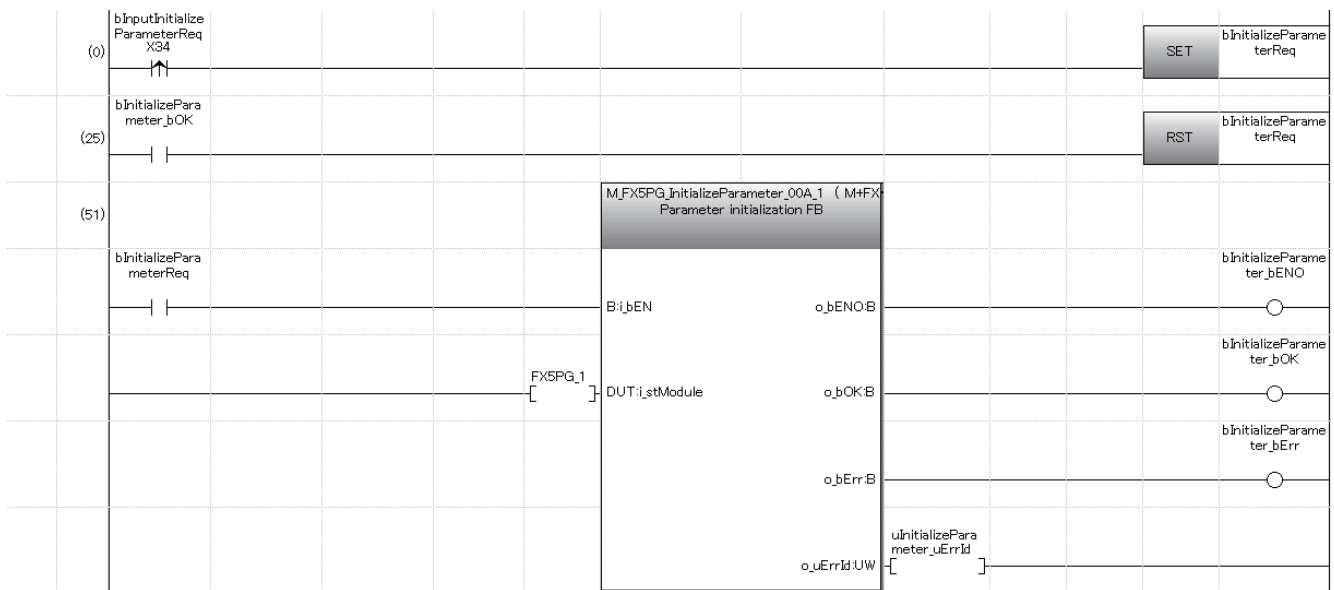

Module backup program

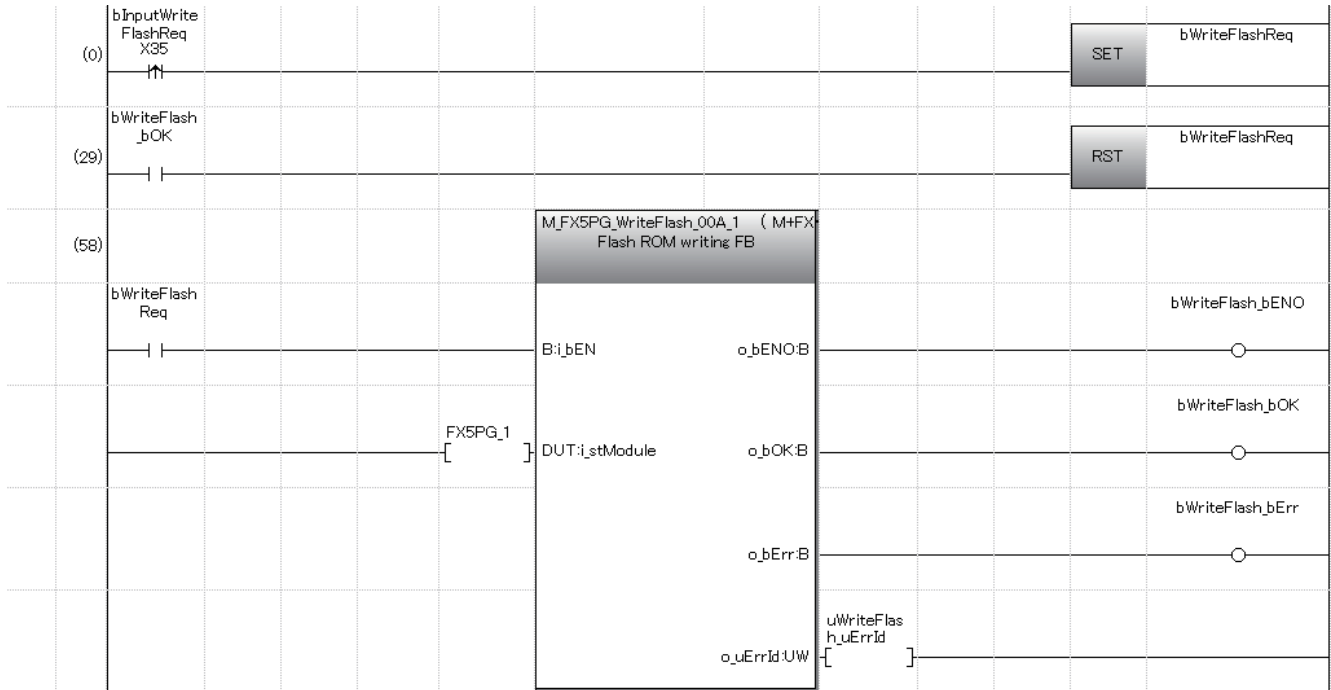

Error reset program

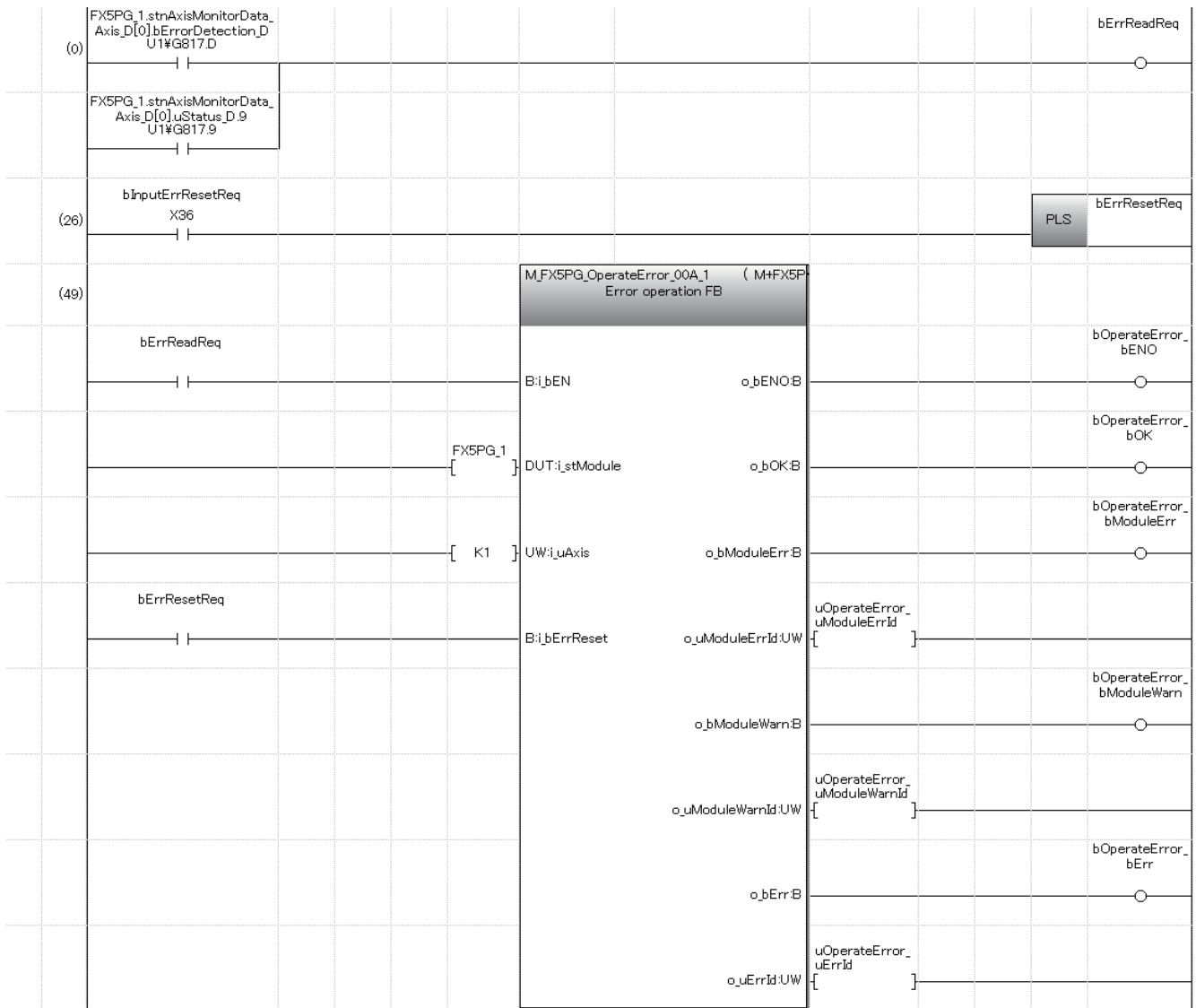

Stop program

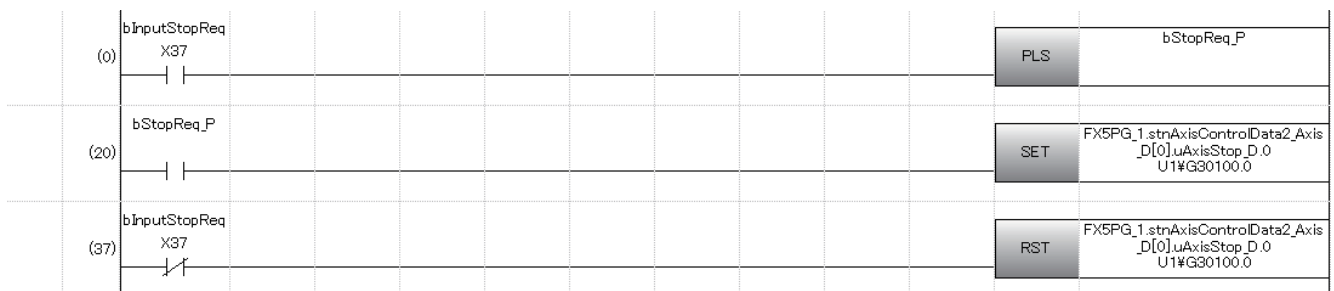

19 TROUBLESHOOTING

This chapter describes errors that may occur when the positioning module is used, and those troubleshooting.

19.1 Troubleshooting Procedure

If a problem occurs, perform troubleshooting by following the procedure below.

1. Check that each module is mounted correctly.
 [MELSEC iQ-F FX5UJ User's Manual (Hardware)]
 [MELSEC iQ-F FX5U User's Manual (Hardware)]
 [MELSEC iQ-F FX5UC User's Manual (Hardware)]
2. Check the LEDs on the CPU module.
 [MELSEC iQ-F FX5UJ User's Manual (Hardware)]
 [MELSEC iQ-F FX5U User's Manual (Hardware)]
 [MELSEC iQ-F FX5UC User's Manual (Hardware)]
3. Check that each module is operating correctly with its LEDs. (☞ Page 512 Checks with LEDs)
4. Check the GX Works3 positioning monitor screen for any module errors. (☞ Page 513 Check of module status)

Checks with LEDs

By checking the display status of LEDs, the problem can be primarily diagnosed without GX Works3 and the cause is narrowed down.

The positioning module status can be checked with the RUN LED and the ERROR LED. The following table lists the positioning module status and the corresponding LED displays.

□: OFF, ■: ON, ●: Flashing (flashing interval: ON: 200 ms/OFF: 200 ms)

Positioning module status	LED display		Description	Indication
Power is off	AX1□ AX2□	POWER□ RUN□ ERROR□	Positioning module power is off	—
Normal operation (RUN LED is ON, ERROR LED is OFF)	AX1□ AX2□	POWER■ RUN■ ERROR□	Axes stopped Axes on standby	—
	AX1■ AX2□	POWER■ RUN■ ERROR□	Axes in operation	The LED remains on from the positioning start until the axis stops at completion of positioning or with an error.
Operation failure	AX1● AX2□	POWER■ RUN■ ERROR■	Minor error	Check the error code of the error using the positioning monitor window of GX Works3 and take the action according to the list of error codes.
	AX1□ AX2□	POWER■ RUN■ ERROR●	Moderate error	
	AX1□ AX2□	POWER■ RUN□ ERROR□	Error (Initialization not completed)	

All LEDs are off

Check item	Action
The power is not supplied.	Check that the voltage supplied to the positioning module is within the rated range.
The power supply connector is not connected correctly.	Check if the power connector is inserted correctly.
The power cable is not wired correctly.	Check for any issues in the wiring to the external power supply.

The RUN LED has turned off

Check item	Action
The power is not supplied.	Check that the voltage supplied to the CPU module is within the rated range.
The capacity of the power supply module is not sufficient.	Calculate the total current consumption of mounted CPU module, I/O modules, and intelligent function modules and check that the power capacity is sufficient.
Modules are not connected correctly.	Check if the extension cable is inserted correctly.

The ERROR LED has turned on and an axis display LED is flashing

Check item	Action
A minor error has occurred.	Check the error code and take the action.

The ERROR LED is flashing

Check item	Action
A moderate error has occurred.	An error may have occurred on the CPU module. Check the error on the CPU module and take the action.

Check of module status

Error codes (warning codes) and error logs for the positioning module can be checked with the GX Works3 module diagnostics screen.

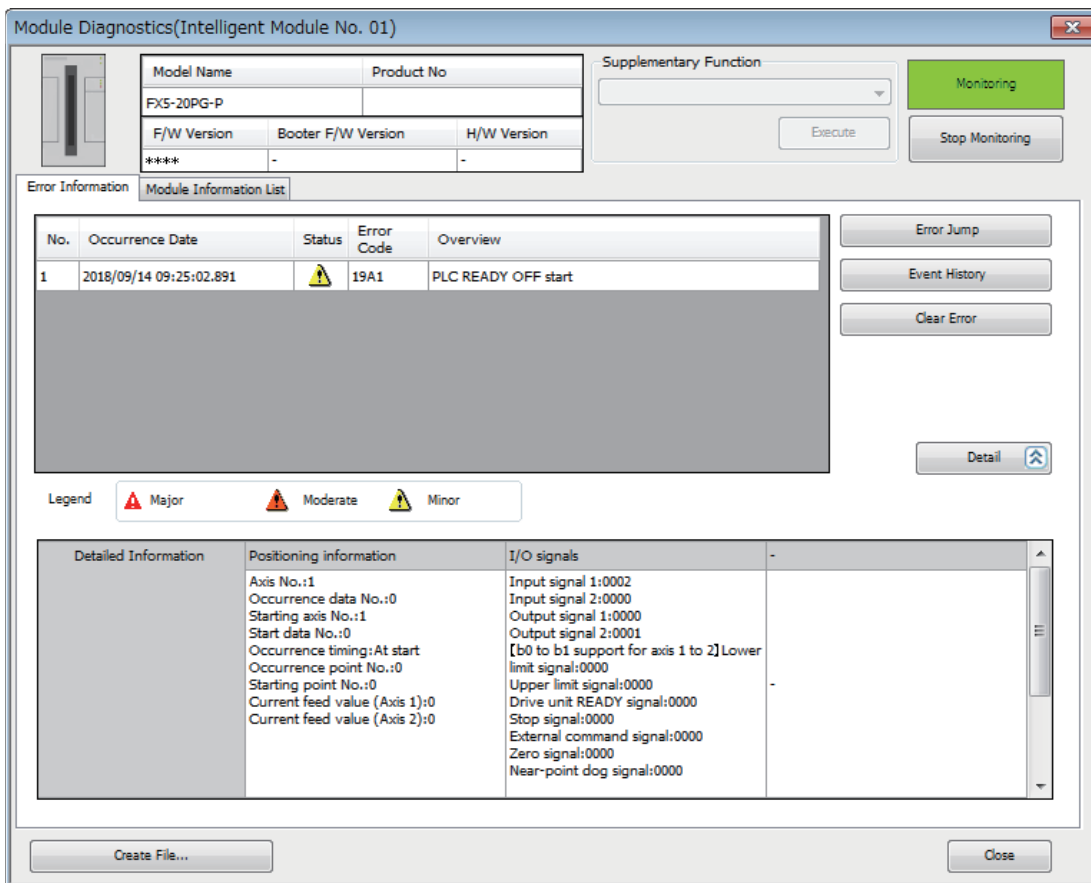

19.2 Troubleshooting by Symptom

A motor does not rotate

The check items and actions are listed below.

Check item	Action
PLC READY signal is off.	Review and edit the program so that [Cd.190] PLC READY signal turns on.
The drive unit is not powered on.	Power on the drive unit.
An error may have occurred on the drive unit.	Check the error code of the drive unit and take the action.
The positioning module is not wired to the drive unit correctly.	Check and correct the wiring between the positioning module and the drive unit.
The drive unit is not wired to the motor correctly.	Check and correct the wiring between the drive unit and the motor.
The limit signals are not wired correctly.	Check the wiring and logic setting of the limit signals and correct them.
An error may have occurred on the positioning module. (The ERROR LED is on or flashing.)	Check the error code and take the action.
1: Stopped is stored in [Md.26] Axis operation status.	<ul style="list-style-type: none"> • Review the stop program. • Check that Stop signal (STOP) is not accidentally input.
The value in [Md.20] Current feed value did not change even after the execution of positioning.	Review the start program.
The number of input pulses in the monitor of the drive unit did not change even after the execution of positioning. ^{*1}	Refer to the manual for the drive unit used and check that the function to suppress the motor rotation is not working.
The pulse output mode setting does not meet the specifications of the drive unit.	Set a value in [Pr.5] Pulse output mode so that the setting meets the specifications of the drive unit.
The output logic setting of the command pulse signal does not meet the specifications of the drive unit.	Set the logic of the command pulse signal ([Pr.23] Output signal logic selection: b0) so that the setting meets the specifications of the drive unit.

*1 Check this item only when the drive unit has a monitor function of the number of input pulses.

If a motor does not rotate even after the above items are checked, the possible cause is a module failure. Please consult your local Mitsubishi representative.

A motor does not rotate as intended

The check items and actions are listed below.

■A motor rotates only in one direction

Check item	Action
The wiring is not correct.	Check that the signal line of the pulse output (for axis 1, connector pin No. A15 to A18) is correctly wired and not disconnected.
The pulse output mode setting does not meet the specifications of the drive unit.	Set a value in [Pr.5] Pulse output mode so that the setting meets the specifications of the drive unit.

■A motor rotates in the reverse direction

Check item	Action
The wiring is not correct.	Check that the signal line of the pulse output (for axis 1, connector pin No. A15 to A18) is correctly wired (CW and CCW or A phase and B phase is not reversely wired).
The setting of [Pr.6] Rotation direction setting and the logic of the command pulse signal ([Pr.23] Output signal logic selection: b0) do not match the setting of the drive unit.	Set the value in [Pr.6] Rotation direction setting and set the logic of the command pulse signal ([Pr.23] Output signal logic selection: b0) so that they meet the setting of the drive unit.

■A motor does not rotate at the set speed

Check item	Action
The value in [Md.28] Axis feedrate is same with or different from the set speed.	[When the value in [Md.28] Axis feedrate is same with the set speed] <ul style="list-style-type: none"> Using a 16-bit electronic gear: Check that settings of [Pr.2] No. of pulses per rotation (16 bits), [Pr.3] Movement amount per rotation (16 bits), and [Pr.4] Unit magnification are appropriate for the system. Using a 32-bit electronic gear: Check that settings of [Pr.2] No. of pulses per rotation (32 bits) and [Pr.3] Movement amount per rotation (32 bits) are appropriate for the system. When the drive unit has the electronic gear function, check that the settings meet the system.
	[When the value in [Md.28] Axis feedrate is different from the set speed] <ul style="list-style-type: none"> Check that the speed is not limited by the value in [Pr.8] Speed limit value. In JOG operation, check that the speed is not limited by the value in [Pr.31] JOG speed limit value. Check that "[Cd.181] Forward JOG start signal" or "[Cd.182] Reverse JOG start signal" do not repeatedly turn on and off during JOG operation.

■The object did not reach the set position

Check item	Action
The value in [Md.20] Current feed value is same with or different from the set position.	[When the value in [Md.20] Current feed value has reached the set position] <ul style="list-style-type: none"> Using a 16-bit electronic gear: Check that settings of [Pr.2] No. of pulses per rotation (16 bits), [Pr.3] Movement amount per rotation (16 bits), and [Pr.4] Unit magnification are appropriate for the system. Using a 32-bit electronic gear: Check that settings of [Pr.2] No. of pulses per rotation (32 bits) and [Pr.3] Movement amount per rotation (32 bits) are appropriate for the system. When the drive unit has the electronic gear function, check that the settings meet the system.
	[When the value in [Md.20] Current feed value has not reached the set position] <ul style="list-style-type: none"> If the motor is stopped by [Cd.180] Axis stop signal or Stop signal (STOP), the [Md.26] Axis operation status changes to "1: Stopped". If the motor is stopped with an axis error, "-1: Error" is stored in [Md.26] Axis operation status. Check the error code and take the action described in the following.  Page 524 List of Error Codes

19.3 Error and Warning Details

Error type

Errors detected by the MELSEC iQ-F series modules are classified into three levels: major error, moderate error, and minor error.

The positioning module detects moderate errors and minor errors.

Moderate errors and minor errors include parameter setting range errors and errors at the operation start or during operation.

Parameter setting range errors

Parameters are checked on the rising edge of [Cd.190] PLC READY signal (turning on of the signal) and if the setting of a parameter is not correct, an error occurs.

Check that the READY signal ([Md.140] Module status: b0) does not turn on when this error occurs.

To clear this error, set the correct value in the parameter with the error and turn on [Cd.190] PLC READY signal.

Errors at the operation start or during operation

There are the errors that occur at the start or during operation in positioning control, JOG operation, or inching operation.

If an axis error has occurred during interpolation operation, Error No. is stored both in the reference axis and in the interpolation axis.

Note that Error No. is not stored in the axis to be interpolated or simultaneous starting axis for the following cases.

- The interpolation axis is BUSY

Axis error No. is stored only in the reference axis during analysis of positioning data.

- An error has occurred in positioning data or parameters that are not related to interpolation control

Axis error No. is stored only in the reference axis during analysis of positioning data.

- An error has occurred before the execution of simultaneous start of positioning (such as invalid axis No. and other axis BUSY)

Error before simultaneous start (error code: H1990, H1991) is stored in the starting axis.

- An error has occurred after the execution of simultaneous start of positioning (such as positioning data error and software stroke limit error)

The corresponding error code is stored in the axis where the error has occurred.

Simultaneous start not possible (error code: 199EH) is stored in all axes where the error has not occurred because the simultaneous start cannot be carried out. "-1: Error" is stored in [Md.26] Axis operation status of the axis where the error has occurred.

If an error occurs during operation, any moving axis decelerates to a stop and "-1: Error" is stored in [Md.26] Axis operation status. During interpolation operation, if an error occurs even in one axis, all axes decelerate to a stop.

Error code classification

Error level	Error code	Error type
Moderate error	3000H to 3BFFH	H/W error
Minor error	17C0H to 17DFH	Module extension parameter file error
	1800H to 185FH	Error at interrupt function setting range check
	1860H to 18BFH	Dedicated instruction error
	1900H to 193FH	Error common to positioning control
	1940H to 197FH	Error at OPR or absolute position restoration
	1980H to 198FH	Error in manual control
	1990H to 19EFH	Error in positioning operation
	19F0H to 19FFH	Block start data setting error
	1A00H to 1A0FH	Condition data setting error
	1A10H to 1A5FH	Positioning data setting error
	1A60H to 1A9FH	Error at basic parameter setting range check
	1AA0H to 1AFFH	Error at detailed parameter setting range check
	1B00H to 1B3FH	Error at OPR parameter setting range check
	1B40H to 1B9FH	Error at extension/system parameter setting range check

Error storage

If a moderate error or a minor error has occurred, Error detection signal turns on, and the corresponding error code is stored in the following buffer memory address of [Md.23] Axis error No. Every time an error occurs, [Md.23] Axis error No. is overwritten with the latest error code.

Axis No.	Buffer memory address	
	Error detection signal ([Md.31] Status: b13)	[Md.23] Axis error No.
1	817	806
2	917	906

If any of the following errors is detected, the error code is stored in [Md.23] Axis error No. of axis 1.

- 1080H: Flash ROM write number error
- 1800H: Interrupt factor setting error
- 1801H: Axis No. for interrupt factor setting error
- 190AH: PLC READY OFF → ON during the BUSY state
- 1930H: Hold error
- 1931H: Flash ROM write error
- 1932H: Flash ROM sum check error
- 3001H: Fault
- 3002H: Internal circuit fault
- 3020H: CPU module error
- 3022H: System bus error

Warning type

Warnings include the ones that occur in each operation (positioning operation, manual pulse generator operation, and JOG operation) and the ones that occur in the settings common to positioning control.

Warning classification

Warning code	Warning type
0900H to 093FH	Warning common to positioning control
0980H to 098FH	Warning in manual operation (JOG operation and manual pulse generator operation)
0990H to 09EFH	Warning in positioning operation
0A10H to 0A5FH	Warning at positioning data setting range check
09F0H to 09FFH	Block start data setting warning
0B00H to 0B02H	Extension parameter acquisition warning

Warning storage

If a warning has occurred, the corresponding warning code is stored in the following buffer memory address of [Md.24] Axis warning No.

Axis No.	Buffer memory address ([Md.24] Axis warning No.)
1	807
2	907

If a warning has occurred in positioning operation, 1 is stored in the following buffer memory address of [Md.31] Status, Axis warning detection (b9).

Axis No.	Buffer memory address ([Md.31] Status)
1	817
2	917

Clearing errors or warnings

Eliminate the cause of an error or warning by referring to the actions described in the following, and clear the error or warning using the error reset.

☞ Page 520 List of Warning Codes

☞ Page 524 List of Error Codes

Clearing errors/warnings by each axis

By setting 1 to the following buffer memory address of [Cd.5] Axis error reset, the error or warning is cleared after the completion of the processing below.

Axis No.	Buffer memory address ([Cd.5] Axis error reset)
1	1502
2	1602

■ Processing

- Error detection signal ([Md.31] Status: b13) is turned off
- [Md.23] Axis error No. is cleared.
- [Md.24] Axis warning No. is cleared.
- The value in [Md.26] Axis operation status changes from "-1: Error" to "0: Standby".
- [Md.31] Status, Axis warning detection (b9) is turned off

Clearing errors/warnings of all axes collectively

By setting 1 to [Cd.49] All axes error reset, errors or warnings of all axes are collectively cleared.





Axis No.	Buffer memory address ([Cd.49] All axes error reset)
All axes	1933

■ Processing

- Error detection signal ([Md.31] Status: b13) is turned off
- [Md.23] Axis error No. is cleared.
- [Md.24] Axis warning No. is cleared.
- The value in [Md.26] Axis operation status changes from "-1: Error" to "0: Standby".
- [Md.31] Status, Axis warning detection (b9) is turned off

19.4 List of Warning Codes

Warning code	Warning name	Cause and description	Action
■Warning common to positioning control			
0900H	Start during operation	The start request has been performed while the axis is in BUSY state. [Operation of when the warning has occurred] The operation is continued.	Do not perform the start request while the axis is in BUSY state.
0901H	Deviation counter clear request	The deviation counter clear has been requested while the axis is in BUSY state. [Operation of when the warning has occurred] The deviation counter clear request is ignored.	Do not request the deviation counter clear while the axis is in BUSY state.
0902H	Restart not possible	The restart command has been performed when the axis operation status is not Stopped. [Operation of when the warning has occurred] The operation is continued.	Perform the restart command when the axis operation status is stopped.
0903H	Teaching in BUSY	The teaching has been requested while the axis is in BUSY state. [Operation of when the warning has occurred] An error occurs in the axis that is subject to the teaching.	Request the teaching when the axis is not in BUSY state.
0904H	Less than speed 1	The speed changed with the override function became less than 1 in the unit that is currently set. [Operation of when the warning has occurred] The operation is controlled at the speed of 1.	Set a value for the override function so that the changed speed becomes 1 or more in the unit that is currently set.
0905H	PLC READY ON write	The write request to the flash ROM has been performed while [Cd.190] PLC READY signal is on. [Operation of when the warning has occurred] Data is not written to the flash ROM.	Perform the write request to the flash ROM while [Cd.190] PLC READY signal is off.
0906H	Illegal override value	A value other than 0 to 300 is set in [Cd.13] Positioning operation speed override. [Operation of when the warning has occurred] The speed is changed as 300 is set.	Correct the value within the setting range. For details, refer to  Page 473 [Cd.13] Positioning operation speed override.
0907H	Outside new torque value range	The value set in [Cd.22] New torque value is greater than the value in [Pr.17] Torque limit setting value. [Operation of when the warning has occurred] The torque is controlled with the value in [Pr.17] Torque limit setting value.	Set the value equal to or smaller than [Pr.17] Torque limit setting value to [Cd.22] New torque value. For details, refer to the following.  Page 399 [Pr.17] Torque limit setting value  Page 476 [Cd.22] New torque value
0908H	Below bias speed	The value in [Da.8] Command speed is smaller than the value in [Pr.7] Bias speed at start. [Operation of when the warning has occurred] The positioning is performed at the speed of [Pr.7] Bias speed at start.	Correct the values in [Da.8] Command speed/[Pr.7] Bias speed at start so that the command speed is equal to or greater than the bias speed at start. For details, refer to the following.  Page 391 [Pr.7] Bias speed at start  Page 430 [Da.8] Command speed
0909H	Analysis mode change in BUSY	The value in [Cd.43] Analysis mode setting has been changed while the axis is operating. [Operation of when the warning has occurred] The change of [Cd.43] Analysis mode setting is ignored.	Do not change the value in [Cd.43] Analysis mode setting when the axis operation status is not Standby.
090AH	PLC READY ON read	The read request from the flash ROM has been performed while [Cd.190] PLC READY signal is on. [Operation of when the warning has occurred] Data is not read from the flash ROM.	Perform the read request from the flash ROM while [Cd.190] PLC READY signal is off.
090BH	Restart not possible	The restart command has been performed in pre-analysis mode. [Operation of when the warning has occurred] The positioning does not restart.	Do not perform the restart command in pre-analysis mode. (The warning code: 0902H is recognized prior to 090BH.)
■Warning in manual operation (JOG operation and manual pulse generator operation)			
0980H	Speed change during deceleration	The speed change has been requested while the operation is decelerating to a stop by turning off of the JOG start signal. [Operation of when the warning has occurred] The speed is not changed.	Do not change JOG speed while the operation is decelerating by turning off of the JOG start signal.

Warning code	Warning name	Cause and description	Action
0981H	JOG speed limit value	JOG speed at the start is over the speed set in [Pr.31] JOG speed limit value. [Operation of when the warning has occurred] JOG operation is controlled at the speed set in [Pr.31] JOG speed limit value. (In speed limit flag is on while the speed is limited with [Pr.31] JOG speed limit value.)	Correct the value within the setting range. For details, refer to  Page 405 [Pr.31] JOG speed limit value.
0982H	JOG speed limit value	A value greater than the one in [Pr.31] JOG speed limit value has been set to change the speed during JOG operation. [Operation of when the warning has occurred] JOG operation is controlled at the speed set in [Pr.31] JOG speed limit value. (In speed limit flag is on while the speed is limited with [Pr.31] JOG speed limit value.)	Correct the value within the setting range. For details, refer to  Page 405 [Pr.31] JOG speed limit value.
0988H	Outside manual pulse generator input magnification range	A value of 0, 10001, or greater is set in [Cd.20] Manual pulse generator 1 pulse input magnification. [Operation of when the warning has occurred] • A value of 10001 or greater is set as the input magnification: Set the value to 10000. • A value of 0 is set as the input magnification: Set the value to 1.	Correct the value within the setting range. For details, refer to  Page 475 [Cd.20] Manual pulse generator 1 pulse input magnification.
■Warning in positioning operation			
0990H	Deceleration/stop speed change	The speed change has been requested while the operation is decelerating or stopped. [Operation of when the warning has occurred] The speed is not changed.	Do not request the speed change during the deceleration by a stop command, the operation stop, or the automatic deceleration in the position control.
0991H	Speed limit value over	A value greater than the one in [Pr.8] Speed limit value has been set to change the speed during operation. [Operation of when the warning has occurred] • The speed is controlled with the value in [Pr.8] Speed limit value. • In speed limit flag is on.	Correct the changed value within 0 to [Pr.8] Speed limit value. For details, refer to  Page 473 [Cd.14] New speed value.
0992H	M code ON signal ON	M code ON signal is on when the positioning data where "11: Continuous path control" is set in [Da.1] Operation pattern has been executed. [Operation of when the warning has occurred] The execution of positioning data is continued.	Check and correct the on/off timing of [Cd.7] M code ON signal OFF request.
0993H	Speed-position switching signal ON during acceleration	A speed-position switching signal has been turned on while the operation is accelerating in speed-position switching control (INC mode). [Operation of when the warning has occurred] The operation is continued.	Do not turn on a speed-position switching signal during acceleration.
0994H	Insufficient remaining distance	The operation has been interrupted with [Cd.18] Continuous operation interrupt request when the remaining distance is not enough for the deceleration. [Operation of when the warning has occurred] ■At the command speed change The speed close to [Cd.14] New speed value is applied to the change. ■At the target position change The target position is changed after the speed is adjusted to be closer to [Cd.28] Target position change value (new speed). (When "11: Continuous path control" is set in [Da.1] Operation pattern, the descriptions above are not applied.)	Turn on the request when the remaining distance is sufficient.
0995H	Insufficient remaining distance	The speed change has been requested when the remaining distance is not enough for the speed change. [Operation of when the warning has occurred] ■At the command speed change The speed close to [Cd.14] New speed value is applied to the change. ■At the target position change The target position is changed after the speed is adjusted to be closer to [Cd.28] Target position change value (new speed). (When "11: Continuous path control" is set in [Da.1] Operation pattern, the descriptions above are not applied.)	Turn on the request when the remaining distance is sufficient.

Warning code	Warning name	Cause and description	Action
0996H	Step not possible	1: Step continue is set in [Cd.36] Step start request when 0: Do not carry out step operation is set in [Cd.35] Step valid flag or "-2: Step standby" is not set in [Md.26] Axis operation status. [Operation of when the warning has occurred] The step does not start.	Do not set 1: Step continue in [Cd.36] Step start request when 0: Do not carry out step operation is set in [Cd.35] Step valid flag or "-2: Step standby" is not set in [Md.26] Axis operation status.
0997H	Illegal external command function	A value outside the setting range is set in [Pr.42] External command function selection of detailed parameter 2. [Operation of when the warning has occurred] Nothing changes in the operation even if External command signal has been tuned on.	Correct the value within the setting range. For details, refer to  Page 412 [Pr.42] External command function selection.
0998H	Insufficient movement amount	Movement amount is not enough for automatic deceleration. [Operation of when the warning has occurred] The positioning stops immediately when the object has reached the positioning address.	Set the address or movement amount necessary for the deceleration to positioning data.
0999H	Illegal teaching data No.	The positioning data No. outside the setting range is set. [Operation of when the warning has occurred] The teaching is not performed.	Set the positioning data No. within the setting range. For details, refer to  Page 480 [Cd.39] Teaching positioning data No.
099AH	Illegal teaching data selection	The value outside the setting range is set in [Cd.38] Teaching data selection. [Operation of when the warning has occurred] The teaching is not performed.	Correct the value within the setting range. For details, refer to  Page 480 [Cd.38] Teaching data selection.
099BH	Target position change not possible	The target position change has been requested while the control other than ABS1 and INC1 in [Da.2] Control method is being executed. [Operation of when the warning has occurred] The target position is not changed.	Do not turn on Target position change request flag while the control other than ABS1 and INC1 in [Da.2] Control method is being executed.
099CH	Target position change not possible	Target position change request flag has been turned on in continuous path control. [Operation of when the warning has occurred] The target position is not changed.	Do not turn on Target position change request flag when Continuous path control is set.
099DH	Target position change not possible	The target position change has been requested while the operation is decelerating to a stop. [Operation of when the warning has occurred] The target position is not changed.	Do not turn on Target position change request flag during deceleration stop.
099EH	Target position change not possible	The target position change has been requested when Speed change 0 flag ([Md.31] Status: b10) is on. [Operation of when the warning has occurred] The target position is not changed.	Do not turn on Target position change request flag when Speed change 0 flag ([Md.31] Status: b10) is on.
099FH	Target position change not possible	The value set in [Cd.27] Target position change value (new address) is outside the software stroke limit range (+). [Operation of when the warning has occurred] The target position is not changed.	Correct the value in [Cd.27] Target position change value (new address) if it is outside the software stroke limit range (+). For details, refer to  Page 478 [Cd.27] Target position change value (new address).
09A0H	Target position change not possible	The value set in "[Cd.27] Target position change value (new address)" is outside the software stroke limit range (-). [Operation of when the warning has occurred] The target position is not changed.	Correct the value in "[Cd.27] Target position change value (new address)" if it is outside the software stroke limit range (-). For details, refer to  Page 478 [Cd.27] Target position change value (new address).
09A1H	Target position change not possible	When the unit is degree, the value other than 0 to 359.99999 is set in [Cd.27] Target position change value (new address). [Operation of when the warning has occurred] The target position is not changed.	Correct the value of [Cd.27] Target position change value (new address) within the setting range. For details, refer to  Page 478 [Cd.27] Target position change value (new address).
09A2H	Pre-analysis incomplete start	A positioning start trigger has been input before 1: Analysis completed is stored in [Md.61] Analysis complete flag. [Operation of when the warning has occurred] A pulse output starts once positioning data analysis is completed and 1: Analysis completed is stored in [Md.61] Analysis complete flag.	Start positioning after 1: Analysis completed is stored in [Md.61] Analysis complete flag.
09A4H	Manual control start in pre-analysis mode	The manual control is started in pre-analysis mode. [Operation of when the warning has occurred] The manual control does not start.	Perform the manual control after 0: Normal analysis mode is set in [Cd.43] Analysis mode setting.













Warning code	Warning name	Cause and description	Action
09A6H	Step start disabled	1: Step continue has been set in [Cd.36] Step start request in pre-analysis mode. [Operation of when the warning has occurred] The step does not start.	Do not set 1: Step continue in [Cd.36] Step start request in pre-analysis mode.
		Positioning data analysis has been performed after 1: Carry out step operation was set in [Cd.35] Step valid flag. [Operation of when the warning has occurred] The step operation is not performed.	Do not set 1: Carry out step operation in [Cd.35] Step valid flag.
09A7H	Positioning start signal input at quick external start	Positioning start signal has been input when 0: Start with external command is set in [Pr.42] External command function selection and 1: External command valid is set in [Cd.8] External command valid. [Operation of when the warning has occurred] The positioning does not start.	Do not input Positioning start signal.
09A8H	Pre-analysis not possible	A value other than 1 to 600 has been set in [Cd.3] Positioning start No. during positioning data analysis in pre-analysis mode. [Operation of when the warning has occurred] After the start trigger is input, the same operation in normal analysis mode is started while the state remains in pre-analysis mode.	Set a value within 1 to 600 in [Cd.3] Positioning start No.
09A9H	Pre-analysis not possible	The axis to be interpolated is not in pre-analysis mode during positioning data analysis in pre-analysis mode. [Operation of when the warning has occurred] After the start trigger is input, the same operation in normal analysis mode is started while the state remains in pre-analysis mode.	Change the state of the axis to be interpolated to pre-analysis mode as well.
■Warning at positioning data setting range check			
0A10H	Outside command speed range	The speed set in [Da.8] Command speed is over the speed set in [Pr.8] Speed limit value. [Operation of when the warning has occurred] <ul style="list-style-type: none"> [Da.8] Command speed is controlled with [Pr.8] Speed limit value. In speed limit flag is on. 	<ul style="list-style-type: none"> Correct a value in [Da.8] Command speed within the setting range. For details, refer to  Page 430 [Da.8] Command speed. Correct the set value in the [Cd.13] Positioning operation speed override. For details, refer to  Page 473 [Cd.13] Positioning operation speed override.
■Block start data setting warning			
09F0H	No operation termination setting	The 50th point of block start data is set to Continue when the positioning has been performed with block start data. [Operation of when the warning has occurred] The operation ends.	Set the 50th point of block start data to End.
09F1H	FOR to NEXT nest construction	FOR to NEXT is nested. [Operation of when the warning has occurred] The operation is continued.	Do not configure FOR to NEXT nest construction.
■Extension parameter acquisition warning			
0B00H	Extension parameter acquisition error	Extension parameters have not been acquired. (no file) [Operation of when the warning has occurred] The setting values of extension parameters of buffer memory become as follows. <ul style="list-style-type: none"> Power-on: Factory default setting value Running: Setting value just before RUN 	Write extension parameters to the storage location set in the extension parameter storage setting, and change the CPU module status from STOP to RUN.
0B01H	Extension parameter acquisition error	Extension parameters have not been acquired. (data error) [Operation of when the warning has occurred] The setting values of extension parameters of buffer memory become factory default setting values.	Write extension parameters to the storage location set in the extension parameter storage setting, and change the CPU module status from STOP to RUN.
0B02H	Extension parameter acquisition error	Extension parameters have not been acquired. (retry count over) [Operation of when the warning has occurred] The setting values of extension parameters of buffer memory become factory default setting values.	<ul style="list-style-type: none"> Change the CPU module status from STOP to RUN. Set Positioning module in the extension parameter storage setting.

19.5 List of Error Codes









Error code	Error name	Cause and description	Action
■Error common to the CPU			
1080H	Flash ROM write number error	Writing to the flash ROM has been executed more than 25 times in a row with the program. [Operation of when the error has occurred] Data is not written to the flash ROM.	<ul style="list-style-type: none"> Correct the program so that writing to the flash ROM is not executed in a row. (The number of write accesses to the flash ROM can be checked with [Md.19] No. of write accesses to flash ROM.) If this error has occurred when the module is used correctly, data can be written after the error is reset, the system is powered off and on, or the CPU module is reset.
■Module extension parameter file error			
17C3H	Module extension parameter writing error	The "Extended parameter storage setting" is set to "CPU", and error has occurred while executing module data backup function or module data initialization function. [Operation of when the error has occurred] The module data backup function or the module data initialization function does not operate.	Check the free space on the data memory of the CPU and the SD memory card, and execute the module data backup function or the module data initialization function.
17C4H	Module extension parameter writing error	The "Extended parameter storage setting" was set to "CPU", and the module data backup function or module data initialization function was executed while the CPU module was in the RUN state. [Operation of when the error has occurred] The module data backup function or the module data initialization function does not operate.	Execute the module data backup function or the module data initialization function when the CPU module is in the STOP state.
■Error at interrupt function setting range check			
1800H	Interrupt factor setting error	The value outside the setting range is set in the interrupt factor setting. [Operation of when the error has occurred] The interrupt function does not operate.	Correct the value of the interrupt factor setting and turn on [Cd.190] PLC READY signal.
1801H	Axis No. for interrupt factor setting error	The value outside the setting range is set in the axis No. for interrupt factor. [Operation of when the error has occurred] The interrupt function does not operate.	Correct the value of the axis No. for interrupt factor and turn on [Cd.190] PLC READY signal.
■Dedicated instruction error			
1860H	Dedicated instruction error	The G.ABRST□ instruction has been executed when the value other than 0 is stored in the status. (at the communication start with a servo amplifier) [Operation of when the error has occurred] The positioning function corresponding to each dedicated instruction is not executed.	Set 0 in the status when executing the G.ABRST□ instruction. Refer to □MELSEC iQ-F FX5 Programming Manual (Instructions, Standard Functions/Function Blocks) for more information.
1861H	Dedicated instruction error	The status has been changed during absolute position restoration (during communication with a servo amplifier) by the G.ABRST□ instruction. [Operation of when the error has occurred] The positioning function corresponding to each dedicated instruction is not executed.	Do not change the status during absolute position restoration by the G.ABRST□ instruction. Refer to □MELSEC iQ-F FX5 Programming Manual (Instructions, Standard Functions/Function Blocks) for more information.
1862H	Dedicated instruction error	The GP.PSTRT □ instruction has been executed when a value other than 1 to 600, 7000 to 7004, and 9001 to 9004 is stored in the start No. [Operation of when the error has occurred] The positioning function corresponding to each dedicated instruction is not executed.	Choose the start number within the setting range when executing the GP.PSTRT□ instruction. Refer to □MELSEC iQ-F FX5 Programming Manual (Instructions, Standard Functions/Function Blocks) for more information.
1863H	Dedicated instruction error	The GP.TEACH□ instruction has been executed when a value other than 0 and 1 is set in the teaching data selection. [Operation of when the error has occurred] The positioning function corresponding to each dedicated instruction is not executed.	Set 0 or 1 in the teaching data selection when executing the GP.TEACH□ instruction. Refer to □MELSEC iQ-F FX5 Programming Manual (Instructions, Standard Functions/Function Blocks) for more information.

Error code	Error name	Cause and description	Action
1864H	Dedicated instruction error	The GP.TEACH□ instruction has been executed when a value other than 1 to 600 is set in the teaching positioning data No. [Operation of when the error has occurred] The positioning function corresponding to each dedicated instruction is not executed.	Set the value within the setting range in the teaching positioning data No. (1 to 600) when executing the GP.TEACH□ instruction. Refer to □MELSEC iQ-F FX5 Programming Manual (Instructions, Standard Functions/Function Blocks) for more information.
1865H	Dedicated instruction error	The G.ABRST□, GP.PSTRTO□, or GP.TEACH□ instruction has been executed with a non-existent axis being specified as the target of the instruction. [Operation of when the error has occurred] The positioning function corresponding to each dedicated instruction is not executed.	Do not specify a non-existent axis as the target of the instruction when executing the G.ABRST□, GP.PSTRTO□, or GP.TEACH□ instruction. Refer to □MELSEC iQ-F FX5 Programming Manual (Instructions, Standard Functions/Function Blocks) for more information.
1867H 1868H 1869H	Dedicated instruction I/F error	The interface of the CPU module does not match the interface of the positioning module. [Operation of when the error has occurred] The specified dedicated instruction is not accepted.	Check the dedicated instruction that is being executed. If the instruction has no problem, the possible cause is a module failure. Therefore replace the module with another one. Refer to □MELSEC iQ-F FX5 Programming Manual (Instructions, Standard Functions/Function Blocks) for more information.
1870H	Dedicated instruction error	The G.ABRST□ instruction was executed when [Cd.190] PLC READY signal turned on. [Operation of when the error has occurred] The absolute position restoration is not performed.	Execute the G.ABRST□ instruction when the [Cd.190] PLC READY signal is off.
18B0H	Error at switching from normal operation mode to amplifier-less operation mode	<ul style="list-style-type: none"> Input signals other than Module access flag ([Md.140] Module status: b1) are on when switching from the normal operation mode to the amplifier-less operation mode. The module was switched from the normal operation mode to the amplifier-less operation mode during test mode. [Operation of when the error has occurred] The operation mode is not switched.	<ul style="list-style-type: none"> Switch the operation mode after checking that all the input signals other than Module access flag ([Md.140] Module status: b1) are off. Switch the operation mode after confirming that the module is not in the test mode.
18B1H	Error at switching from amplifier-less operation mode to normal operation mode	Input signals other than Module access flag ([Md.140] Module status: b1) are on when switching from the amplifier-less operation mode to normal operation mode. [Operation of when the error has occurred] The operation mode is not switched.	Switch the operation mode after checking that all the input signals other than Module access flag ([Md.140] Module status: b1) are off.
■Error common to positioning control			
1900H	PLC READY OFF during operation	[Cd.190] PLC READY signal has been turned off during operation. [Operation of when the error has occurred] The operation stops according to the setting of [Pr.38] Stop group 2 sudden stop selection of detailed parameter 2 (deceleration stop/sudden stop). (for manual pulse generator operation, deceleration stop only)	Correct the program with which [Cd.190] PLC READY signal is turned on or off.
1901H	Drive unit READY OFF	The start request has been performed while Drive unit READY signal is off. [Operation of when the error has occurred] The operation does not start.	<ul style="list-style-type: none"> Check the power supply of the drive unit, wiring between the drive unit and other devices, and the connection status (connector). Check the setting of [Pr.22] Input signal logic selection. When using the drive unit without the READY signal output, wire a system so that the input of Drive unit READY signal is always on in the positioning module.
1902H	Drive unit READY OFF	Drive unit READY signal has been turned off during operation. [Operation of when the error has occurred] The operation stops immediately.	Check the power supply of the drive unit, wiring between the drive unit and other devices, and the connection status (connector).
1903H	Test mode faults during operation	Communication failed between the personal computer and the CPU module. [Operation of when the error has occurred] The operation stops according to the setting of [Pr.38] Stop group 2 sudden stop selection of detailed parameter 2 (deceleration stop/sudden stop). (for manual pulse generator operation, deceleration stop only)	<ul style="list-style-type: none"> Check that the interface of the personal computer where the cable is connected has no problem. Check that the cable connecting the personal computer to the CPU module has no problem.











Error code	Error name	Cause and description	Action
1904H	Hardware stroke limit (+)	The start request has been performed while Upper limit signal (FLS) is off. [Operation of when the error has occurred] The operation does not start.	<ul style="list-style-type: none"> Check the wiring of Upper limit signal (FLS). Check that the specifications of the limit switch match the setting of [Pr.22] Input signal logic selection. For the system that does not require the limit switch installation, wire it so that the input of Upper limit signal (FLS) is always on in the positioning module.
1905H	Hardware stroke limit (+)	Upper limit signal (FLS) has been turned off during operation. [Operation of when the error has occurred] The operation stops according to the setting of [Pr.37] Stop group 1 sudden stop selection of detailed parameter 2 (deceleration stop/sudden stop). (for manual pulse generator operation, deceleration stop only)	<ul style="list-style-type: none"> After performing the axis error reset, move the object with a manual operation to the position where Upper limit signal (FLS) is not turned off. Check the wiring of Upper limit signal (FLS).
1906H	Hardware stroke limit (-)	The start request has been performed while Lower limit signal (RLS) is off. [Operation of when the error has occurred] The operation does not start.	<ul style="list-style-type: none"> Check the wiring of Lower limit signal (RLS). Check that the specifications of the limit switch match the setting of [Pr.22] Input signal logic selection. For the system that does not require the limit switch installation, wire it so that the input of Lower limit signal (RLS) is always on in the positioning module.
1907H	Hardware stroke limit (-)	Lower limit signal (RLS) has been turned off during operation. [Operation of when the error has occurred] The operation stops according to the setting of [Pr.37] Stop group 1 sudden stop selection of detailed parameter 2 (deceleration stop/sudden stop). (for manual pulse generator operation, deceleration stop only)	<ul style="list-style-type: none"> After performing the axis error reset, move the object with a manual operation to the position where Lower limit signal (RLS) is not turned off. Check the wiring of Lower limit signal (RLS).
1908H	Stop signal ON at start	The start request has been performed while Stop signal is on. [Operation of when the error has occurred] The operation does not start.	Correct the timing so that the operation starts after the stop command is cleared.
1909H	Stop signal ON at start	The start request has been performed while External stop signal is on. [Operation of when the error has occurred] The operation does not start.	Correct the timing so that the operation starts after the external stop is cleared.
190AH	PLC READY OFF → ON during BUSY	The [Cd.190] PLC READY signal turned on while the [Md.141] BUSY signal was on. [Operation of when the error has occurred] Check that READY signal ([Md.140] Module status: b0) does not turn on.	Turn on the [Cd.190] PLC READY signal when the [Md.141] BUSY signal is off.
1930H	Hold error	The parameter "CPU error output mode setting" is set to "Hold" for the positioning module. [Operation of when the error has occurred] Check that READY signal ([Md.140] Module status: b0) does not turn on.	Set the parameter "CPU error output mode setting" to "Clear".
1931H	Flash ROM write error	Data cannot be written to the flash ROM. [Operation of when the error has occurred] Data cannot be written to the flash ROM correctly.	The flash ROM may be at the end of writable life. Set the extended parameter storage setting to "CPU", or replace the module with another one.
1932H	Flash ROM sum check error	The system has been powered off while data is being written to the flash ROM. [Operation of when the error has occurred] Data cannot be written to the flash ROM correctly.	Return the value of the parameter to the factory default.
■Error at OPR or absolute position restoration			
1940H	Start at OP	When [Pr.48] OPR retry is set to 0 (Do not perform OPR retry by limit switch), the machine OPR has been performed using the near-point dog method with OPR complete flag being on. [Operation of when the error has occurred] The machine OPR is not started.	<ul style="list-style-type: none"> Set 1 (Perform the OPR retry with limit switches) in [Pr.48] OPR retry. For details, refer to  Page 417 [Pr.48] OPR retry. Perform the machine OPR after moving the object from the current position (OP) with a manual operation.
1941H	Dog detection timing fault	At the machine OPR using the near-point dog method, Near-point dog signal has turned off while the speed is decelerating from OPR speed to creep speed. [Operation of when the error has occurred] The operation stops according to the setting of [Pr.39] Stop group 3 sudden stop selection of detailed parameter 2 (deceleration stop/sudden stop).	<ul style="list-style-type: none"> Slow down the OPR speed. For details, refer to  Page 415 [Pr.46] OPR speed. Make the input time of Near-point dog signal longer.





Error code	Error name	Cause and description	Action
1942H	Zero signal detection timing fault	At the machine OPR using the stopper method 2, Zero signal has turned off while the speed is decelerating from OPR speed to creep speed. [Operation of when the error has occurred] The operation stops according to the setting of [Pr.39] Stop group 3 sudden stop selection of detailed parameter 2 (deceleration stop/sudden stop).	<ul style="list-style-type: none"> Slow down the OPR speed. For details, refer to  Page 415 [Pr.46] OPR speed. Input Zero signal while the object is moving at creep speed when inputting the signal from an external source. For details, refer to  Page 88 Stopper method 2.
1943H	Dwell time fault	At the machine OPR using the stopper method 1, the dwell time has passed while the speed is decelerating from OPR speed to creep speed. [Operation of when the error has occurred] The operation stops according to the setting of [Pr.39] Stop group 3 sudden stop selection of detailed parameter 2 (deceleration stop/sudden stop).	<ul style="list-style-type: none"> Slow down the OPR speed. For details, refer to  Page 415 [Pr.46] OPR speed. Set a greater value in [Pr.49] OPR dwell time. For details, refer to  Page 417 [Pr.49] OPR dwell time.
1944H	Count method movement amount fault	At the machine OPR using the count method 1 or 2, the distance set in [Pr.50] Setting for the movement amount after near-point dog ON is shorter than the distance required from the [Pr.46] OPR speed to the deceleration stop. [Operation of when the error has occurred] The machine OPR is not started.	<ul style="list-style-type: none"> Calculate the movement amount of the object from the speed limit value, OPR speed, and deceleration time, and set [Pr.50] Setting for the movement amount after near-point dog ON so that the movement amount is longer than the deceleration distance. For details, refer to  Page 418 [Pr.50] Setting for the movement amount after near-point dog ON. Set the smaller value in [Pr.46] OPR speed.
1945H	OPR request ON	OPR request flag is on at the fast OPR start (Positioning start No. 9002). [Operation of when the error has occurred] The fast OPR is not started.	Execute the machine OPR (Positioning start No. 9001).
1946H	OPR restart not possible	Restart command has been turned on after the machine OPR stop with Stop signal. [Operation of when the error has occurred] The operation does not restart.	Execute the machine OPR (Positioning start No.9001) again.
1947H	Signal allocation error	Near-point dog signal has turned on and the hardware stroke limit switch in the OPR direction has turned off at the OPR using the near-point dog method. [Operation of when the error has occurred] The operation stops according to the setting of [Pr.39] Stop group 3 sudden stop selection of detailed parameter 2 (deceleration stop/sudden stop).	Install limit switches so that the areas where Near-point dog signal is on and the hardware stroke limit switch in the OPR direction is off do not overlap each other.
1949H	ABS transmission time out	Communication with a servo amplifier failed during absolute position restoration using the dedicated instruction. [Operation of when the error has occurred]	<ul style="list-style-type: none"> Correct the wiring. For details, refer to  Page 49 WIRING. Correct the program.
194AH	ABS transmission SUM	The absolute position restoration is not performed.	<ul style="list-style-type: none"> Correct the wiring. For details, refer to  Page 49 WIRING. Correct the program. Correct the control data of the dedicated instruction. Refer to  MELSEC iQ-F FX5 Programming Manual (Instructions, Standard Functions/Function Blocks) for more information.
■Error in manual control			
1980H	Outside JOG speed range	The value outside the setting range is set in [Cd.17] JOG speed at the JOG start. [Operation of when the error has occurred] The JOG operation is not performed.	Correct the value of [Cd.17] JOG speed within the setting range. For details, refer to  Page 474 [Cd.17] JOG speed.
1981H	Inching movement amount error	The value to meet the setting condition is not set in [Cd.16] Inching movement amount. (The setting value is large.) ■Setting conditions (Inching movement amount) × (A) ≤ (JOG speed limit value) The value of (A) is as follows. • When the unit setting is pulse: 562.5 • When the unit setting is a value other than pulse: 337.5 [Operation of when the error has occurred] The inching operation is not performed.	Set a smaller value in [Cd.16] Inching movement amount to meet the setting condition. For details, refer to the following.  Page 204 Inching Operation  Page 405 [Pr.31] JOG speed limit value  Page 474 [Cd.16] Inching movement amount

Error code	Error name	Cause and description	Action
1990H	Error before simultaneous start	<ul style="list-style-type: none"> The partner axis for the simultaneous start is in BUSY state. The partner axis for the simultaneous start does not exist. [Operation of when the error has occurred] The operation is not performed.	<ul style="list-style-type: none"> Start the operation after BUSY state of the simultaneous starting axis is cleared. Specify an axis that exists for the simultaneous starting axis.
1991H	Error before simultaneous start	<ul style="list-style-type: none"> The simultaneous starting axis start data No. of the starting axis is 0 or a value outside the setting range. The simultaneous starting axis start data No. of the axis other than the starting axis is a value outside the setting range. [Operation of when the error has occurred] The operation is not performed.	Correct the simultaneous starting axis start data No. For details, refer to the following. ☞ Page 479 [Cd.30] Simultaneous starting axis start data No. (Axis 1 start data No.) ☞ Page 479 [Cd.31] Simultaneous starting axis start data No. (Axis 2 start data No.)
1993H	Software stroke limit (+)	In manual control or in speed control, the positioning has been performed at the position where the current feed value is over [Pr.12] Software stroke limit upper limit value. (If the machine feed value is selected in [Pr.14] Software stroke limit selection, it becomes the target for the stroke limit.) [Operation of when the error has occurred] ■At the start of operation The operation is not performed. ■During operation In speed control ("during speed control" in speed-position switching control and in position-speed switching control included), the operation stops according to the setting in [Pr.39] Stop group 3 sudden stop selection of detailed parameter 2 (deceleration stop only) when a value in [Md.20] Current feed value or in [Md.21] Machine feed value has become outside the software stroke limit range in manual operation.	If the current feed value or machine feed value is outside the software stroke limit range, move the object to the position within the software stroke limit range with a manual operation.
1994H	Software stroke limit (+)	The new current value is over [Pr.12] Software stroke limit upper limit value. [Operation of when the error has occurred] The current value change is not performed.	Correct the new current value within the software stroke limit range. For details, refer to ☞ Page 472 [Cd.9] New current value.
1995H	Software stroke limit (-)	In manual control or in speed control, the positioning has been performed at the position where the current feed value is below [Pr.13] Software stroke limit lower limit value. (If the machine feed value is selected in [Pr.14] Software stroke limit selection, it becomes the target for the stroke limit.) [Operation of when the error has occurred] ■At the start of operation The operation is not performed. ■During operation In speed control ("during speed control" in speed-position switching control and in position-speed switching control included), the operation stops according to the setting in [Pr.39] Stop group 3 sudden stop selection of detailed parameter 2 (deceleration stop only) when a value in [Md.20] Current feed value or in [Md.21] Machine feed value has become outside the software stroke limit range in manual operation.	If the current feed value or machine feed value is outside the software stroke limit range, move the object to the position within the software stroke limit range with a manual operation.
1996H	Software stroke limit (-)	The new current value is below [Pr.13] Software stroke limit lower limit value. [Operation of when the error has occurred] The current value change is not performed.	Correct the new current value within the software stroke limit range. For details, refer to ☞ Page 472 [Cd.9] New current value.
1997H	Outside new current value range	When the unit is degree, the value other than 0 to 359.99999 is set in [Cd.9] New current value. [Operation of when the error has occurred] The current value change is not performed.	Correct the new current value within the setting range. For details, refer to ☞ Page 472 [Cd.9] New current value.

Error code	Error name	Cause and description	Action
■Error in positioning operation			
1998H	Interpolation while partner axis BUSY	The interpolation operation has been started while the partner axis is operating. [Operation of when the error has occurred] The operation is not performed.	<ul style="list-style-type: none"> • Correct the value in [Da.2] Control method. For details, refer to  Page 425 [Da.2] Control method. • Change the axis to be interpolated. For details, refer to  Page 426 [Da.5] Axis to be interpolated. • Start the operation after BUSY state of the axis to be interpolated is cleared.
1999H	Unit group unmatched	The units of the reference axis and interpolation axis differ when Composite speed is set in [Pr.20] Interpolation speed specification method or [Da.29] Interpolation speed specification method. [Operation of when the error has occurred] ■At the start of operation The operation is not performed. ■During operation <ul style="list-style-type: none"> • The operation stops according to the setting of [Pr.39] Stop group 3 sudden stop selection of detailed parameter 2 (deceleration stop/sudden stop). • The operation stops at the stop position while the speed is 0. 	<p>Correct the positioning data or a value in [Pr.1] Unit setting of the interpolation axis.</p> <p>For details, refer to the following.</p> <ul style="list-style-type: none">  Page 117 Interpolation control  Page 385 [Pr.1] Unit setting  Page 401 [Pr.20] Interpolation speed specification method  Page 433 [Da.29] Interpolation speed specification method
199AH	Interpolation mode error	In interpolation control, the operation has been performed with Composite speed being set in [Pr.20] Interpolation speed specification method of the reference axis. [Operation of when the error has occurred] ■At the start of operation The operation is not performed. ■During operation <ul style="list-style-type: none"> • The operation stops according to the setting of [Pr.39] Stop group 3 sudden stop selection of detailed parameter 2 (deceleration stop/sudden stop). • The operation stops at the stop position while the speed is 0. 	Correct the value in [Pr.20] Interpolation speed specification method. For details, refer to  Page 401 [Pr.20] Interpolation speed specification method.
199BH	Interpolation mode error	In circular interpolation control, the operation has been performed with Reference axis speed being set in [Pr.20] Interpolation speed specification method of the reference axis. [Operation of when the error has occurred] ■At the start of operation The operation is not performed. ■During operation <ul style="list-style-type: none"> • The operation stops according to the setting of [Pr.39] Stop group 3 sudden stop selection of detailed parameter 2 (deceleration stop/sudden stop). • The operation stops at the stop position while the speed is 0. 	Correct the value in [Pr.20] Interpolation speed specification method. For details, refer to  Page 401 [Pr.20] Interpolation speed specification method.
199CH	Control method setting error	The machine OPR, fast OPR, speed-position switching control, or position-speed switching control has been performed in wiring-less mode. [Operation of when the error has occurred] ■At the start of operation The operation is not performed. ■During operation <ul style="list-style-type: none"> • The operation stops according to the setting of [Pr.39] Stop group 3 sudden stop selection of detailed parameter 2 (deceleration stop/sudden stop). • The operation stops at the stop position while the speed is 0. 	Correct the value in [Da.2] Control method. For details, refer to  Page 425 [Da.2] Control method.
199DH	Control method setting error	A value other than 0 is set in the buffer memory address 1906 (use prohibited area). [Operation of when the error has occurred] ■At the start of operation The operation is not performed. ■During operation <ul style="list-style-type: none"> • The operation stops according to the setting of [Pr.39] Stop group 3 sudden stop selection of detailed parameter 2 (deceleration stop/sudden stop). • The operation stops at the stop position while the speed is 0. 	Do not set any value in the buffer memory address 1906 (use prohibited area).









Error code	Error name	Cause and description	Action
199EH	Simultaneous start not possible	An error (except the error of 199EH) has occurred in any of the simultaneous starting axes. [Operation of when the error has occurred] The operation is not performed.	<ul style="list-style-type: none"> Find the axis where the error (except the error of 199EH) has occurred with the error history and eliminate the error cause. Correct the block start data and positioning data. For details, refer to the following. <ul style="list-style-type: none"> Page 423 Positioning Data Page 434 Block Start Data
199FH	Circular interpolation not possible	The circular interpolation has been performed to the axis using degree as the unit. [Operation of when the error has occurred] <ul style="list-style-type: none"> At the start of operation The operation is not performed. <ul style="list-style-type: none"> During operation The operation stops according to the setting of [Pr.39] Stop group 3 sudden stop selection of detailed parameter 2 (deceleration stop/sudden stop).	<ul style="list-style-type: none"> Correct the value in [Da.2] Control method or [Pr.1] Unit setting. For details, refer to the following. <ul style="list-style-type: none"> Page 385 [Pr.1] Unit setting Page 425 [Da.2] Control method
19A0H	M code ON signal ON start	The positioning has been performed while M code ON signal ([Md.31] Status: b12) is on. [Operation of when the error has occurred] The operation is not performed.	Turn off M code ON signal ([Md.31] Status: b12) before starting operation. For details, refer to Page 287 M code output function.
19A1H	PLC READY OFF start	The positioning has been performed while [Cd.190] PLC READY signal is off. [Operation of when the error has occurred] The operation is not performed.	Check the program with which [Cd.190] PLC READY signal is turned on or off and start the positioning after [Cd.190] PLC READY signal is turned on.
19A2H	READY OFF start	Positioning control started while the positioning module READY signal ([Md.140] Module status: b0) was off. [Operation of when the error has occurred] The operation is not performed.	Check that the READY signal ([Md.140] Module status: b0) is on before starting operation.
19A3H	Outside start No. range	At the positioning start, the setting value of Positioning start No. of axis control data is other than 1 to 600, 7000 to 7004, and 9001 to 9004. [Operation of when the error has occurred] The operation is not performed.	Correct the value of the positioning start No. For details, refer to Page 470 [Cd.3] Positioning start No.
19A4H	Illegal setting of ABS direction in unit of degree	A value outside the setting range is set in [Cd.40] ABS direction in degrees when the software stroke limit is invalid and the unit is degree. [Operation of when the error has occurred] <ul style="list-style-type: none"> At the start of operation The operation is not performed. <ul style="list-style-type: none"> During operation The operation stops according to the setting of [Pr.39] Stop group 3 sudden stop selection of detailed parameter 2 (deceleration stop/sudden stop).	Correct the value in [Cd.40] ABS direction in degrees within the setting range. For details, refer to Page 481 [Cd.40] ABS direction in degrees.
19A5H	Illegal setting of ABS direction in unit of degree	A value other than 0 is set in [Cd.40] ABS direction in degrees when the software stroke limit is valid and the unit is degree. [Operation of when the error has occurred] <ul style="list-style-type: none"> At the start of operation The operation is not performed. <ul style="list-style-type: none"> During operation The operation stops according to the setting of [Pr.39] Stop group 3 sudden stop selection of detailed parameter 2 (deceleration stop/sudden stop).	<ul style="list-style-type: none"> Set 0 in [Cd.40] ABS direction in degrees. For details, refer to Page 481 [Cd.40] ABS direction in degrees. Invalidate the software stroke limit. (The stroke limit is invalidated when Software stroke limit upper limit value = Software stroke limit lower limit value.)
19A6H	Start error at OPR completion	The positioning has been performed with OPR request flag being on when 0: Do not execute the positioning control is set in [Pr.58] Setting of operation during uncompleted OPR. [Operation of when the error has occurred] The operation is not performed.	<ul style="list-style-type: none"> Start the positioning after OPR is completed. For the system where positioning control is possible with OPR request flag being on, set 1 to [Pr.58] Setting of operation during uncompleted OPR. For details, refer to Page 422 [Pr.58] Setting of operation during uncompleted OPR.







Error code	Error name	Cause and description	Action
■Block start data setting error			
19F0H	Illegal condition data No.	The positioning of block start using condition data has been performed by the special start instruction (condition start, wait start, simultaneous start, repeated start (FOR condition)) when the condition data No. is outside the setting range. ($1 \leq \text{Condition data No.} \leq 10$) [Operation of when the error has occurred] ■At the start of operation The operation is not performed. ■During operation The operation ends.	Correct the condition data No. For details, refer to  Page 437 [Da.14] Parameter.
19F1H	Error before simultaneous start	The partner axis for the simultaneous start of block start is in BUSY state. [Operation of when the error has occurred] ■At the start of operation The operation is not performed. ■During operation The operation ends.	<ul style="list-style-type: none"> • Correct the condition operator. For details, refer to  Page 439 [Da.16] Condition operator. • Start the operation after BUSY state of the simultaneous starting axis is cleared.
19F2H	Special start instruction error	The special start instruction is not corresponding to the operation. [Operation of when the error has occurred] ■At the start of operation The operation is not performed. ■During operation The operation ends.	Correct the special start instruction. For details, refer to  Page 436 [Da.13] Special start instruction.
■Condition data setting error			
1A00H	Condition data error	The condition target is not set or the value is outside the setting range. [Operation of when the error has occurred] ■At the start of operation The operation is not performed. ■During operation The operation ends.	Correct the block start data. For details, refer to  Page 438 [Da.15] Condition target.
1A01H	Condition data error	The condition operator is not set or the value is outside the setting range. [Operation of when the error has occurred] ■At the start of operation The operation is not performed. ■During operation The operation ends.	Correct the block start data. For details, refer to  Page 439 [Da.16] Condition operator.
1A02H	Condition data error	The condition operator is a bit operator and the parameter 1 is 32 or more. [Operation of when the error has occurred] ■At the start of operation The operation is not performed. ■During operation The operation ends.	Correct the block start data. For details, refer to the following.  Page 437 [Da.14] Parameter  Page 439 [Da.16] Condition operator
1A04H	Condition data error	The condition operator is 05H ($P1 \leq \text{VAL} \leq P2$) or 06H ($\text{VAL} \leq P1, P2 \leq \text{VAL}$) and the parameter 1 is greater than the parameter 2. [Operation of when the error has occurred] ■At the start of operation The operation is not performed. ■During operation The operation ends.	Correct the block start data. For details, refer to the following.  Page 440 [Da.18] Parameter 1  Page 441 [Da.19] Parameter 2
1A05H	Condition data error	The condition target is buffer memory (1 word/2 words) and the value of the address is outside the setting range. (1 word: 0 to 32767, 2 words: 0 to 32766) [Operation of when the error has occurred] ■At the start of operation The operation is not performed. ■During operation The operation ends.	Correct the block start data. For details, refer to  Page 439 [Da.17] Address.

Error code	Error name	Cause and description	Action
■Positioning data setting error			
1A10H	Illegal data No.	The positioning data No. for the JUMP destination is currently being executed. [Operation of when the error has occurred] ■At the start of operation The operation is not performed. ■During operation The operation ends.	Correct the positioning data. For details, refer to  Page 431 [Da.9] Dwell time.
1A11H	Illegal data No.	A value other than 1 to 600 is set as the positioning data No. for the JUMP destination. [Operation of when the error has occurred] ■At the start of operation The operation is not performed. ■During operation The operation ends.	Correct the positioning data. For details, refer to  Page 431 [Da.9] Dwell time.
1A12H	No command speed	At the OPR or the positioning start of position control, the command speed was set to -1 (current speed) for the positioning data that was to be executed firstly. [Operation of when the error has occurred] The operation is not performed.	Correct the positioning data. For details, refer to  Page 430 [Da.8] Command speed.
1A13H	No command speed	The command speed is set to -1 (current speed) when the speed control has been performed. [Operation of when the error has occurred] The operation is not performed.	Correct the positioning data. For details, refer to  Page 430 [Da.8] Command speed.
1A14H	No command speed	The command speed is set to -1 (current speed) when the speed-position switching control or the position-speed switching control has been performed. [Operation of when the error has occurred] The operation is not performed.	Correct the positioning data. For details, refer to  Page 430 [Da.8] Command speed.
1A15H	Outside linear movement amount range	The movement amount of each axis set to the positioning data is over 1073741824 ($2^{30} \times 30$) when the linear interpolation control has been performed with "0: Composite speed" being set in [Pr.20] Interpolation speed specification method. [Operation of when the error has occurred] ■At the start of operation The operation is not performed. ■During operation The operation stops immediately.	Correct the value in "[Da.6] Positioning address/movement amount". For details, refer to  Page 427 [Da.6] Positioning address/movement amount.
1A16H	Outside linear movement amount range	When the unit is degree, the value in [Pr.12] Software stroke limit upper limit value is not equal to the value in \neq [Pr.13] Software stroke limit lower limit value and the positioning address for the control of incremental system is -360.00000 or smaller or 360.00000 or greater. [Operation of when the error has occurred] ■At the start of operation The operation is not performed. ■During operation The operation stops immediately.	Correct the value in "[Da.6] Positioning address/movement amount". For details, refer to  Page 427 [Da.6] Positioning address/movement amount.
1A17H	Large arc error deviation	The difference of "distance (radius) of start point and center point" and "distance (radius) of end point and center point" is over the value in Allowable circular interpolation error width when the circular interpolation control has been performed with the center point being specified. [Operation of when the error has occurred] ■At the start of operation The operation is not performed. ■During operation The operation stops immediately.	<ul style="list-style-type: none"> • Correct the center point address (arc address). For details,  Page 429 [Da.7] Arc address refer to the following. • Correct the end point address (positioning address). For details, refer to  Page 427 [Da.6] Positioning address/movement amount.
1A18H	Software stroke limit (+)	The positioning address set in [Da.6] Positioning address/movement amount is over the value in [Pr.12] Software stroke limit upper limit value. [Operation of when the error has occurred] ■At the start of operation The operation is not performed. ■During operation The operation stops immediately.	Correct the value in "[Da.6] Positioning address/movement amount". For details, refer to  Page 427 [Da.6] Positioning address/movement amount.

Error code	Error name	Cause and description	Action
1A19H	Software stroke limit (+)	The sub point is over the value in [Pr.12] Software stroke limit upper limit value when the circular interpolation control has been performed with the sub point being specified. [Operation of when the error has occurred] ■At the start of operation The operation is not performed. ■During operation The operation stops immediately.	<ul style="list-style-type: none"> Correct the sub point address (arc address). For details, refer to Page 429 [Da.7] Arc address. Correct the end point address (positioning address). For details, refer to Page 427 [Da.6] Positioning address/movement amount.
1A1AH	Software stroke limit (-)	The positioning address set in [Da.6] Positioning address/movement amount is below the value in [Pr.13] Software stroke limit lower limit value. [Operation of when the error has occurred] ■At the start of operation The operation is not performed. ■During operation The operation stops immediately.	Correct the value in "[Da.6] Positioning address/movement amount". For details, refer to Page 427 [Da.6] Positioning address/movement amount.
1A1BH	Software stroke limit (-)	The sub point is over the value in [Pr.13] Software stroke limit lower limit value when the circular interpolation control has been performed with the sub point being specified. [Operation of when the error has occurred] ■At the start of operation The operation is not performed. ■During operation The operation stops immediately.	<ul style="list-style-type: none"> Correct the sub point address (arc address). For details, refer to Page 429 [Da.7] Arc address. Correct the end point address (positioning address). For details, refer to Page 427 [Da.6] Positioning address/movement amount.
1A1CH	New current value not possible	"11: Continuous path control" has been set in [Da.1] Operation pattern of the positioning data where Current value change is set in [Da.2] Control method. [Operation of when the error has occurred] The current value change is not performed.	Do not set "11: Continuous path control" in [Da.1] Operation pattern with Current value change being set in [Da.2] Control method. For details, refer to the following. Page 424 [Da.1] Operation pattern Page 425 [Da.2] Control method
1A1DH	New current value not possible	Current value change has been set in [Da.2] Control method of the positioning data next to the one where "11: Continuous path control" is set in [Da.1] Operation pattern. [Operation of when the error has occurred] The current value change is not performed.	Do not set Current value change in [Da.2] Control method of the positioning data next to the one where "11: Continuous path control" is set in [Da.1] Operation pattern. For details, refer to the following. Page 424 [Da.1] Operation pattern Page 425 [Da.2] Control method
1A1EH	Continuous path control not possible	"01: Continuous positioning control" has been set in [Da.1] Operation pattern of the positioning data where the control that cannot perform the continuous positioning control (such as speed control, or position-speed switching control) is set in [Da.2] Control method. [Operation of when the error has occurred] ■At the start of operation The operation is not performed. ■During operation The deceleration stop is performed for [Da.6] Positioning address/movement amount of the previous positioning data according to the value set in [Da.4] Deceleration time No. of the previous positioning data.	Do not set "01: Continuous positioning control" in [Da.1] Operation pattern while the speed control, speed-position-speed switching control is set in [Da.2] Control method. For details, refer to the following. Page 424 [Da.1] Operation pattern Page 425 [Da.2] Control method
1A1FH	Continuous path control not possible	"11: Continuous path control" has been set in [Da.1] Operation pattern of the positioning data where the control that cannot perform the continuous path control (such as speed control, speed-position switching control, position-speed switching control, or fixed-feed control) is set in [Da.2] Control method. [Operation of when the error has occurred] ■At the start of operation The operation is not performed. ■During operation The deceleration stop is performed for [Da.6] Positioning address/movement amount of the previous positioning data according to the value set in [Da.4] Deceleration time No. of the previous positioning data.	Do not set "11: Continuous path control" in [Da.1] Operation pattern while the speed control, speed-position switching control, position-speed switching control, or fixed-feed control is set in [Da.2] Control method. For details, refer to the following. Page 424 [Da.1] Operation pattern Page 425 [Da.2] Control method

Error code	Error name	Cause and description	Action
1A20H	Continuous path control not possible	The speed control, speed-position switching control, position-speed switching control, or fixed-feed control has been set in [Da.2] Control method of the positioning data next to the one where "11: Continuous path control" is set in [Da.1] Operation pattern. [Operation of when the error has occurred] ■At the start of operation The operation is not performed. ■During operation The deceleration stop is performed for [Da.6] Positioning address/movement amount of the previous positioning data according to the value set in [Da.4] Deceleration time No. of the previous positioning data.	Do not set the speed control, speed-position switching control, position-speed switching control, or fixed-feed control in [Da.2] Control method of the positioning data next to the one where "11: Continuous path control" is set in [Da.1] Operation pattern. For details, refer to the following. ☞ Page 424 [Da.1] Operation pattern ☞ Page 425 [Da.2] Control method
1A21H	Outside operation pattern range	The value set in [Da.1] Operation pattern is 2. [Operation of when the error has occurred] ■At the start of operation The operation is not performed. ■During operation The deceleration stop is performed for [Da.6] Positioning address/movement amount of the previous positioning data according to the value set in [Da.4] Deceleration time No. of the previous positioning data.	Correct the value in [Da.1] Operation pattern. For details, refer to ☞ Page 424 [Da.1] Operation pattern.
1A22H	Illegal interpolation description command	The self-axis or an axis that does not exist is set in [Da.5] Axis to be interpolated when the 2-axis interpolation control has been performed. [Operation of when the error has occurred] ■At the start of operation The operation is not performed. ■During operation The deceleration stop is performed for [Da.6] Positioning address/movement amount of the previous positioning data according to the value set in [Da.4] Deceleration time No. of the previous positioning data.	<ul style="list-style-type: none"> Correct the value in [Da.2] Control method. For details, refer to ☞ Page 425 [Da.2] Control method. Correct the value in [Da.5] Axis to be interpolated. For details, refer to ☞ Page 426 [Da.5] Axis to be interpolated.
1A23H	Command speed setting error	The value outside the setting range is set in [Da.8] Command speed. Linear interpolation, circular interpolation: The reference axis is outside the setting range. Speed control interpolation: One axis (the reference axis or interpolation axes) is outside the setting range. [Operation of when the error has occurred] ■At the start of operation The operation is not performed. ■During operation The deceleration stop is performed for [Da.6] Positioning address/movement amount of the previous positioning data according to the value set in [Da.4] Deceleration time No. of the previous positioning data.	Correct the value in [Da.8] Command speed. For details, refer to ☞ Page 430 [Da.8] Command speed.
1A24H	Control method setting error	A value outside the setting range is set in [Da.2] Control method. [Operation of when the error has occurred] ■At the start of operation The operation is not performed. ■During operation The deceleration stop is performed for [Da.6] Positioning address/movement amount of the previous positioning data according to the value set in [Da.4] Deceleration time No. of the previous positioning data.	Correct the value in [Da.2] Control method. For details, refer to ☞ Page 425 [Da.2] Control method.



Error code	Error name	Cause and description	Action
1A25H	Control method setting error	The number of controlled axes or the value in [Da.5] Axis to be interpolated was different from the previous data when positioning data have been successively executed in the continuous positioning control or continuous path control. [Operation of when the error has occurred] ■At the start of operation The operation is not performed. ■During operation The deceleration stop is performed for [Da.6] Positioning address/movement amount of the previous positioning data according to the value set in [Da.4] Deceleration time No. of the previous positioning data.	<ul style="list-style-type: none"> Correct the value in [Da.2] Control method. For details, refer to  Page 425 [Da.2] Control method. Correct the value in [Da.5] Axis to be interpolated. For details, refer to  Page 426 [Da.5] Axis to be interpolated.
1A26H	Control method setting error	The NOP instruction has been set in [Da.2] Control method of the positioning data No.600. [Operation of when the error has occurred] ■At the start of operation The operation is not performed. ■During operation The deceleration stop is performed for [Da.6] Positioning address/movement amount of the previous positioning data according to the value set in [Da.4] Deceleration time No. of the previous positioning data.	Correct the value in [Da.2] Control method. For details, refer to  Page 425 [Da.2] Control method.
1A27H	Sub point setting error	The start point is same with the sub point when the circular interpolation control has been performed with the sub point being specified. [Operation of when the error has occurred] ■At the start of operation The operation is not performed. ■During operation The operation stops immediately.	Correct the sub point address with [Da.7] Arc address. For details, refer to  Page 429 [Da.7] Arc address.
1A28H	Sub point setting error	The end point is same with the sub point when the circular interpolation control has been performed with the sub point being specified. [Operation of when the error has occurred] ■At the start of operation The operation is not performed. ■During operation The operation stops immediately.	Correct the sub point address with [Da.7] Arc address. For details, refer to  Page 429 [Da.7] Arc address.
1A29H	Sub point setting error	The start point, end point, and sub point are in the same straight line when the circular interpolation control has been performed with the sub point being specified. [Operation of when the error has occurred] ■At the start of operation The operation is not performed. ■During operation The operation stops immediately.	Correct the sub point address with [Da.7] Arc address. For details, refer to  Page 429 [Da.7] Arc address.
1A2AH	Sub point setting error	The sub point address is outside the range of -2147483648 to 2147483647 when the circular interpolation control has been performed with the sub point being specified. [Operation of when the error has occurred] ■At the start of operation The operation is not performed. ■During operation The operation stops immediately.	Correct the sub point address with [Da.7] Arc address. For details, refer to  Page 429 [Da.7] Arc address.
1A2BH	End point setting error	The start point is same with the end point when the circular interpolation control has been performed with the sub point being specified. [Operation of when the error has occurred] ■At the start of operation The operation is not performed. ■During operation The operation stops immediately.	Correct the end point address with [Da.6] Positioning address/movement amount. For details, refer to  Page 427 [Da.6] Positioning address/movement amount.

Error code	Error name	Cause and description	Action
1A2CH	End point setting error	The end point address is outside the range of -2147483648 to 2147483647 when the circular interpolation control has been performed with the sub point or the center point being specified. [Operation of when the error has occurred] ■At the start of operation The operation is not performed. ■During operation The operation stops immediately.	Correct the end point address with [Da.6] Positioning address/movement amount. For details, refer to  Page 427 [Da.6] Positioning address/movement amount.
1A2DH	Center point setting error	The start point is same with the center point when the circular interpolation control has been performed with the center point being specified. [Operation of when the error has occurred] ■At the start of operation The operation is not performed. ■During operation The operation stops immediately.	Correct the center point address with [Da.7] Arc address. For details, refer to  Page 429 [Da.7] Arc address.
1A2EH	Center point setting error	The end point is same with the center point when the circular interpolation control has been performed with the center point being specified. [Operation of when the error has occurred] ■At the start of operation The operation is not performed. ■During operation The operation stops immediately.	Correct the center point address with [Da.7] Arc address. For details, refer to  Page 429 [Da.7] Arc address.
1A2FH	Center point setting error	The center point address is outside the range of -2147483648 to 2147483647 when the circular interpolation control has been performed with the center point being specified. [Operation of when the error has occurred] ■At the start of operation The operation is not performed. ■During operation The operation stops immediately.	Correct the center point address with [Da.7] Arc address. For details, refer to  Page 429 [Da.7] Arc address.
1A30H	Outside address range	A negative value is set in [Da.6] Positioning address/movement amount when the speed-position switching control (INC) or the position-speed switching control (INC) has been performed. [Operation of when the error has occurred] ■At the start of operation The operation is not performed. ■During operation The operation stops according to the setting of [Pr.39] Stop group 3 sudden stop selection of detailed parameter 2 (deceleration stop/sudden stop).	Correct the value in "[Da.6] Positioning address/movement amount". For details, refer to  Page 427 [Da.6] Positioning address/movement amount.
1A31H	Outside address range	A value outside the range of 0 to 359.99999 [degree] is set in [Da.6] Positioning address/movement amount when ABS1, ABS2, or speed-position switching control (ABS) has been performed. [Operation of when the error has occurred] ■At the start of operation The operation is not performed. ■During operation The operation stops according to the setting of [Pr.39] Stop group 3 sudden stop selection of detailed parameter 2 (deceleration stop/sudden stop).	Correct the value in "[Da.6] Positioning address/movement amount". For details, refer to  Page 427 [Da.6] Positioning address/movement amount.
1A32H	Outside radius range	The radius of the arc is over 536870912. [Operation of when the error has occurred] ■At the start of operation The operation is not performed. ■During operation The operation stops immediately.	Correct the positioning data. For details, refer to  Page 429 [Da.7] Arc address.

Error code	Error name	Cause and description	Action
1A33H	Control method LOOP setting error	The number of LOOP repetition is 0 when LOOP is set in [Da.2] Control method. [Operation of when the error has occurred] ■At the start of operation The operation is not performed. ■During operation The operation stops according to the setting of [Pr.39] Stop group 3 sudden stop selection of detailed parameter 2 (deceleration stop/sudden stop).	Set a value of 1 to 65535 as the number of LOOP repetition. For details, refer to Page 432 [Da.10] M code.
1A34H	M code ON timing error	A value outside the setting range is set in [Da.27] M code ON signal output timing of positioning data. [Operation of when the error has occurred] ■At the start of operation The operation is not performed. ■During operation The operation stops according to the setting of [Pr.39] Stop group 3 sudden stop selection of detailed parameter 2 (deceleration stop/sudden stop).	Set a value of 0 to 2 in [Da.27] M code ON signal output timing. For details, refer to Page 432 [Da.27] M code ON signal output timing.
1A35H	Interpolation speed specification method error	A value outside the setting range is set in [Da.29] Interpolation speed specification method of the positioning data. [Operation of when the error has occurred] ■At the start of operation The operation is not performed. ■During operation The operation stops according to the setting of [Pr.39] Stop group 3 sudden stop selection of detailed parameter 2 (deceleration stop/sudden stop).	Set a value of 0 to 2 in [Da.29] Interpolation speed specification method. For details, refer to Page 433 [Da.29] Interpolation speed specification method.
1A37H	Sub point setting error	The center point address is outside the range of -2147483648 to 2147483647 when the circular interpolation control has been performed with the sub point being specified. [Operation of when the error has occurred] ■At the start of operation The operation is not performed. ■During operation The operation stops immediately.	Correct the sub point address with [Da.7] Arc address. For details, refer to Page 429 [Da.7] Arc address.
■Error at basic parameter setting range check			
1A60H	Outside unit setting range	A value outside the setting range is set in [Pr.1] Unit setting of basic parameter 1. [Operation of when the error has occurred] Check that READY signal ([Md.140] Module status: b0) does not turn on.	Configure the value so that it is within the setting range and then turn on [Cd.190] PLC READY signal. For details, refer to Page 385 [Pr.1] Unit setting.
1A61H	Outside pulse number per rotation range	A value outside the setting range is set in [Pr.2] No. of pulses per rotation of basic parameter 1. [Operation of when the error has occurred] Check that READY signal ([Md.140] Module status: b0) does not turn on.	Configure the value so that it is within the setting range and then turn on [Cd.190] PLC READY signal. For details, refer to the following. Page 386 [Pr.2] No. of pulses per rotation (16 bits) (Ap) Page 392 [Pr.2] No. of pulses per rotation (32 bits) (Ap)
1A62H	Outside movement amount per rotation range	A value outside the setting range is set in [Pr.3] Movement amount per rotation of basic parameter 1. [Operation of when the error has occurred] Check that READY signal ([Md.140] Module status: b0) does not turn on.	Configure the value so that it is within the setting range and then turn on [Cd.190] PLC READY signal. For details, refer to the following. Page 387 [Pr.3] Movement amount per rotation (16 bits) (Al) Page 393 [Pr.3] Movement amount per rotation (32 bits) (Al)
1A63H	Outside unit magnification range	A value outside the setting range is set in [Pr.4] Unit magnification of basic parameter 1. [Operation of when the error has occurred] Check that READY signal ([Md.140] Module status: b0) does not turn on.	Configure the value so that it is within the setting range and then turn on [Cd.190] PLC READY signal. For details, refer to Page 387 [Pr.4] Unit magnification.
1A64H	Pulse output mode error	A value outside the setting range is set in [Pr.5] Pulse output mode of basic parameter 1. [Operation of when the error has occurred] Check that READY signal ([Md.140] Module status: b0) does not turn on.	Configure the value so that it is within the setting range and then turn on [Cd.190] PLC READY signal. For details, refer to Page 388 [Pr.5] Pulse output mode.

Error code	Error name	Cause and description	Action
1A65H	Rotation direction setting error	A value outside the setting range is set in [Pr.6] Rotation direction setting of basic parameter 1. [Operation of when the error has occurred] Check that READY signal ([Md.140] Module status: b0) does not turn on.	Configure the value so that it is within the setting range and then turn on [Cd.190] PLC READY signal. For details, refer to Page 390 [Pr.6] Rotation direction setting.
1A66H	Outside bias speed range	A value outside the setting range is set in [Pr.7] Bias speed at start of basic parameter 1. [Operation of when the error has occurred] Check that READY signal ([Md.140] Module status: b0) does not turn on.	Configure the value so that it is within the setting range and then turn on [Cd.190] PLC READY signal. For details, refer to Page 391 [Pr.7] Bias speed at start.
1A67H	Outside bias speed range	[Pr.7] Bias speed at start of basic parameter 1 is over [Pr.8] Speed limit value. [Operation of when the error has occurred] Check that READY signal ([Md.140] Module status: b0) does not turn on.	Set values so that [Pr.7] Bias speed at start becomes equal to or below [Pr.8] Speed limit value, and turn on [Cd.190] PLC READY signal. For details, refer to the following. Page 391 [Pr.7] Bias speed at start Page 394 [Pr.8] Speed limit value
1A68H	Outside electronic gear selection	A value outside the setting range is set in [Pr.62] Electronic gear selection of basic parameter 1. [Operation of when the error has occurred] Check that READY signal ([Md.140] Module status: b0) does not turn on.	Configure the value so that it is within the setting range and then turn on [Cd.190] PLC READY signal. For details, refer to Page 392 [Pr.62] Electronic gear selection.
1A69H	Outside speed limit value range	A value outside the setting range is set in [Pr.8] Speed limit value of basic parameter 2. [Operation of when the error has occurred] ■At power-on or at turning on of [Cd.190] PLC READY signal Check that READY signal ([Md.140] Module status: b0) does not turn on. ■At the start of operation The operation is not performed.	Correct the value within the setting range and turn on [Cd.190] PLC READY signal if the signal is off. For details, refer to Page 394 [Pr.8] Speed limit value.
1A6AH	Outside speed limit value range	The command pulse frequency converted from the value in [Pr.8] Speed limit value of basic parameter 2 is over the maximum output pulse of the module. [Operation of when the error has occurred] ■At power-on or at turning on of [Cd.190] PLC READY signal Check that READY signal ([Md.140] Module status: b0) does not turn on. ■At the start of operation The operation is not performed.	Correct the value so that the command pulse frequency is not over the maximum output pulse of the module and then turn on [Cd.190] PLC READY signal if the signal is off. ■Maximum output frequency • FX5-20PG-P: 200 kpulse/s • FX5-20PG-D: 5 Mpulse/s
1A6BH	Outside acceleration time 0 range	A value outside the setting range is set in [Pr.9] Acceleration time 0 of basic parameter 2. [Operation of when the error has occurred] Check that READY signal ([Md.140] Module status: b0) does not turn on.	Correct the value within the setting range and turn on [Cd.190] PLC READY signal if the signal is off. For details, refer to Page 395 [Pr.9] Acceleration time 0, [Pr.10] Deceleration time 0.
1A6CH	Outside deceleration time 0 range	A value outside the setting range is set in [Pr.10] Deceleration time 0 of basic parameter 2. [Operation of when the error has occurred] ■At the start of operation The operation is not performed. ■During operation The operation stops according to the setting of [Pr.39] Stop group 3 sudden stop selection of detailed parameter 2 (deceleration stop/sudden stop). (for manual pulse generator operation, deceleration stop only)	Correct the value within the setting range and turn on [Cd.190] PLC READY signal if the signal is off. For details, refer to Page 395 [Pr.9] Acceleration time 0, [Pr.10] Deceleration time 0.
■Error at detailed parameter setting range check			
1AA0H	Backlash compensation amount error	The number of pulses converted from the movement amount per pulse is 256 or greater. [Operation of when the error has occurred] Check that READY signal ([Md.140] Module status: b0) does not turn on.	Set values so that the number of pulses converted from the movement amount per pulse becomes smaller than 256 and then turn on [Cd.190] PLC READY signal. For details, refer to Page 396 [Pr.11] Backlash compensation amount.
1AA1H	Software stroke limit upper limit	When the unit is degree, a value outside the setting range is set in [Pr.12] Software stroke limit upper limit value of detailed parameter 1. [Operation of when the error has occurred] Check that READY signal ([Md.140] Module status: b0) does not turn on.	Configure the value so that it is within the setting range and then turn on [Cd.190] PLC READY signal. For details, refer to Page 397 [Pr.12] Software stroke limit upper limit value.

Error code	Error name	Cause and description	Action
1AA2H	Software stroke limit upper limit	When the unit other than degree is set, [Pr.12] Software stroke limit upper limit value is smaller than [Pr.13] Software stroke limit lower limit value. (The error code: 1AA4H is stored as well.) [Operation of when the error has occurred] Check that READY signal ([Md.140] Module status: b0) does not turn on.	When the unit is other than degree, set values so that [Pr.12] Software stroke limit upper limit value becomes greater than [Pr.13] Software stroke limit lower limit value, and turn on [Cd.190] PLC READY signal. For details, refer to the following. ☞ Page 397 [Pr.12] Software stroke limit upper limit value ☞ Page 397 [Pr.13] Software stroke limit lower limit value
1AA3H	Software stroke limit lower limit	When the unit is degree, a value outside the setting range is set in [Pr.13] Software stroke limit lower limit value of detailed parameter 1. [Operation of when the error has occurred] Check that READY signal ([Md.140] Module status: b0) does not turn on.	Configure the value so that it is within the setting range and then turn on [Cd.190] PLC READY signal. For details, refer to ☞ Page 397 [Pr.13] Software stroke limit lower limit value.
1AA4H	Software stroke limit lower limit	When the unit other than degree is set, [Pr.12] Software stroke limit upper limit value is smaller than [Pr.13] Software stroke limit lower limit value. (The error code: 1AA2H is stored as well.) [Operation of when the error has occurred] Check that READY signal ([Md.140] Module status: b0) does not turn on.	When the unit is other than degree, set values so that [Pr.12] Software stroke limit upper limit value becomes greater than [Pr.13] Software stroke limit lower limit value, and turn on [Cd.190] PLC READY signal. For details, refer to the following. ☞ Page 397 [Pr.12] Software stroke limit upper limit value ☞ Page 397 [Pr.13] Software stroke limit lower limit value
1AA5H	Software stroke limit selection	A value outside the setting range is set in [Pr.14] Software stroke limit selection of detailed parameter 1. [Operation of when the error has occurred] Check that READY signal ([Md.140] Module status: b0) does not turn on.	Configure the value so that it is within the setting range and then turn on [Cd.190] PLC READY signal. For details, refer to ☞ Page 398 [Pr.14] Software stroke limit selection.
1AA6H	Software stroke limit valid/invalid setting	A value outside the setting range is set in [Pr.15] Software stroke limit valid/invalid setting of detailed parameter 1. [Operation of when the error has occurred] Check that READY signal ([Md.140] Module status: b0) does not turn on.	Configure the value so that it is within the setting range and then turn on [Cd.190] PLC READY signal. For details, refer to ☞ Page 398 [Pr.15] Software stroke limit valid/invalid setting.
1AA7H	Command in-position width	A value outside the setting range is set in [Pr.16] Command in-position width of detailed parameter 1. [Operation of when the error has occurred] Check that READY signal ([Md.140] Module status: b0) does not turn on.	Configure the value so that it is within the setting range and then turn on [Cd.190] PLC READY signal. For details, refer to ☞ Page 398 [Pr.16] Command in-position width.
1AA8H	Illegal torque limit setting value	A value outside the setting range is set in [Pr.17] Torque limit setting value of detailed parameter 1. [Operation of when the error has occurred] Check that READY signal ([Md.140] Module status: b0) does not turn on.	Configure the value so that it is within the setting range and then turn on [Cd.190] PLC READY signal. For details, refer to ☞ Page 399 [Pr.17] Torque limit setting value.
1AA9H	M code ON timing error	A value outside the setting range is set in [Pr.18] M code ON signal output timing of detailed parameter 1. [Operation of when the error has occurred] Check that READY signal ([Md.140] Module status: b0) does not turn on.	Configure the value so that it is within the setting range and then turn on [Cd.190] PLC READY signal. For details, refer to ☞ Page 400 [Pr.18] M code ON signal output timing.
1AAAH	Speed switching mode error	A value outside the setting range is set in [Pr.19] Speed switching mode of detailed parameter 1. [Operation of when the error has occurred] Check that READY signal ([Md.140] Module status: b0) does not turn on.	Configure the value so that it is within the setting range and then turn on [Cd.190] PLC READY signal. For details, refer to ☞ Page 400 [Pr.19] Speed switching mode.
1AABH	Interpolation speed specification method error	A value outside the setting range is set in [Pr.20] Interpolation speed specification method of detailed parameter 1. [Operation of when the error has occurred] Check that READY signal ([Md.140] Module status: b0) does not turn on.	Configure the value so that it is within the setting range and then turn on [Cd.190] PLC READY signal. For details, refer to ☞ Page 401 [Pr.20] Interpolation speed specification method.
1AACH	Current value update request error	A value outside the setting range is set in [Pr.21] Current feed value during speed control of detailed parameter 1. [Operation of when the error has occurred] Check that READY signal ([Md.140] Module status: b0) does not turn on.	Configure the value so that it is within the setting range and then turn on [Cd.190] PLC READY signal. For details, refer to ☞ Page 401 [Pr.21] Current feed value during speed control.

Error code	Error name	Cause and description	Action
1AADH	Manual pulse generator input mode error	A value outside the setting range is set in [Pr.24] Manual pulse generator input selection of detailed parameter 1. [Operation of when the error has occurred] Check that READY signal ([Md.140] Module status: b0) does not turn on.	Configure the value so that it is within the setting range and then turn on [Cd.190] PLC READY signal. For details, refer to  Page 403 [Pr.24] Manual pulse generator input selection.
1AAEH	Speed-position function selection error	Although 2: Speed-position switching control (ABS mode) is set in [Pr.150] Speed-position function selection of detailed parameter 1, the following three conditions are not met. • The unit is degree. • The software stroke limit is invalid. • Current feed value is updated. [Operation of when the error has occurred] Check that READY signal ([Md.140] Module status: b0) does not turn on.	<ul style="list-style-type: none"> When executing the speed-position switching control (ABS mode), set values to meet the three conditions described on the left side. When not executing speed-position switching control (ABS mode), set 0: Speed-position switching control (INC mode) in [Pr.150] Speed-position function selection and turn on [Cd.190] PLC READY signal. For details, refer to  Page 403 [Pr.150] Speed-position function selection.
1AB1H	Acceleration time 1 setting error	A value outside the setting range is set in [Pr.25] Acceleration time 1 of detailed parameter 2. [Operation of when the error has occurred] ■At power-on or at turning on of [Cd.190] PLC READY signal Check that READY signal ([Md.140] Module status: b0) does not turn on. ■At the start of operation The operation is not performed. ■During operation The operation stops according to the setting of [Pr.39] Stop group 3 sudden stop selection of detailed parameter 2 (deceleration stop/sudden stop). (for manual pulse generator operation, deceleration stop only)	Correct the value within the setting range and turn on [Cd.190] PLC READY signal if the signal is off. For details, refer to  Page 404 [Pr.25] Acceleration time 1 to [Pr.27] Acceleration time 3.
1AB2H	Acceleration time 2 setting error	A value outside the setting range is set in [Pr.26] Acceleration time 2 of detailed parameter 2. [Operation of when the error has occurred] ■At power-on or at turning on of [Cd.190] PLC READY signal Check that READY signal ([Md.140] Module status: b0) does not turn on. ■At the start of operation The operation is not performed. ■During operation The operation stops according to the setting of [Pr.39] Stop group 3 sudden stop selection of detailed parameter 2 (deceleration stop/sudden stop). (for manual pulse generator operation, deceleration stop only)	Correct the value within the setting range and turn on [Cd.190] PLC READY signal if the signal is off. For details, refer to  Page 404 [Pr.25] Acceleration time 1 to [Pr.27] Acceleration time 3.
1AB3H	Acceleration time 3 setting error	A value outside the setting range is set in [Pr.27] Acceleration time 3 of detailed parameter 2. [Operation of when the error has occurred] ■At power-on or at turning on of [Cd.190] PLC READY signal Check that READY signal ([Md.140] Module status: b0) does not turn on. ■At the start of operation The operation is not performed. ■During operation The operation stops according to the setting of [Pr.39] Stop group 3 sudden stop selection of detailed parameter 2 (deceleration stop/sudden stop). (for manual pulse generator operation, deceleration stop only)	Correct the value within the setting range and turn on [Cd.190] PLC READY signal if the signal is off. For details, refer to  Page 404 [Pr.25] Acceleration time 1 to [Pr.27] Acceleration time 3.

Error code	Error name	Cause and description	Action
1AB4H	Deceleration time 1 setting error	A value outside the setting range is set in [Pr.28] Deceleration time 1 of detailed parameter 2. [Operation of when the error has occurred] ■At power-on or at turning on of [Cd.190] PLC READY signal Check that READY signal ([Md.140] Module status: b0) does not turn on. ■At the start of operation The operation is not performed. ■During operation The operation stops according to the setting of [Pr.39] Stop group 3 sudden stop selection of detailed parameter 2 (deceleration stop/sudden stop). (for manual pulse generator operation, deceleration stop only)	Correct the value within the setting range and turn on [Cd.190] PLC READY signal if the signal is off. For details, refer to  Page 404 [Pr.28] Deceleration time 1 to [Pr.30] Deceleration time 3.
1AB5H	Deceleration time 2 setting error	A value outside the setting range is set in [Pr.29] Deceleration time 2 of detailed parameter 2. [Operation of when the error has occurred] ■At power-on or at turning on of [Cd.190] PLC READY signal Check that READY signal ([Md.140] Module status: b0) does not turn on. ■At the start of operation The operation is not performed. ■During operation The operation stops according to the setting of [Pr.39] Stop group 3 sudden stop selection of detailed parameter 2 (deceleration stop/sudden stop). (for manual pulse generator operation, deceleration stop only)	Correct the value within the setting range and turn on [Cd.190] PLC READY signal if the signal is off. For details, refer to  Page 404 [Pr.28] Deceleration time 1 to [Pr.30] Deceleration time 3.
1AB6H	Deceleration time 3 setting error	A value outside the setting range is set in [Pr.30] Deceleration time 3 of detailed parameter 2. [Operation of when the error has occurred] ■At power-on or at turning on of [Cd.190] PLC READY signal Check that READY signal ([Md.140] Module status: b0) does not turn on. ■At the start of operation The operation is not performed. ■During operation The operation stops according to the setting of [Pr.39] Stop group 3 sudden stop selection of detailed parameter 2 (deceleration stop/sudden stop). (for manual pulse generator operation, deceleration stop only)	Correct the value within the setting range and turn on [Cd.190] PLC READY signal if the signal is off. For details, refer to  Page 404 [Pr.28] Deceleration time 1 to [Pr.30] Deceleration time 3.
1AB7H	JOG speed limit value error	A value outside the setting range is set in [Pr.31] JOG speed limit value of detailed parameter 2. [Operation of when the error has occurred] ■At power-on or at turning on of [Cd.190] PLC READY signal Check that READY signal ([Md.140] Module status: b0) does not turn on. ■At the start of operation The operation is not performed.	Correct the value within the setting range and turn on [Cd.190] PLC READY signal if the signal is off. For details, refer to  Page 405 [Pr.31] JOG speed limit value.
1AB8H	JOG speed limit value error	A value set in [Pr.31] JOG speed limit value of detailed parameter 2 is over [Pr.8] Speed limit value. [Operation of when the error has occurred] ■At power-on or at turning on of [Cd.190] PLC READY signal Check that READY signal ([Md.140] Module status: b0) does not turn on. ■At the start of operation The operation is not performed.	Correct the value so that [Pr.31] JOG speed limit value is equal to or below [Pr.8] Speed limit value, and turn on [Cd.190] PLC READY signal if the signal is off. For details, refer to the following.  Page 394 [Pr.8] Speed limit value  Page 405 [Pr.31] JOG speed limit value
1AB9H	JOG speed limit value error	The value set in [Pr.31] JOG speed limit value of detailed parameter 2 is below [Pr.7] Bias speed at start. [Operation of when the error has occurred] ■At power-on or at turning on of [Cd.190] PLC READY signal Check that READY signal ([Md.140] Module status: b0) does not turn on. ■At the start of operation The operation is not performed.	Correct the value so that [Pr.31] JOG speed limit value is equal to or over [Pr.7] Bias speed at start, and turn on [Cd.190] PLC READY signal if the signal is off. For details, refer to the following.  Page 394 [Pr.8] Speed limit value  Page 405 [Pr.31] JOG speed limit value

Error code	Error name	Cause and description	Action
1ABCH	JOG acceleration time selection setting error	A value outside the setting range is set in [Pr.32] JOG operation acceleration time selection of detailed parameter 2. [Operation of when the error has occurred] ■At power-on or at turning on of [Cd.190] PLC READY signal Check that READY signal ([Md.140] Module status: b0) does not turn on. ■At the start of operation The operation is not performed.	Correct the value within the setting range and turn on [Cd.190] PLC READY signal if the signal is off. For details, refer to  Page 405 [Pr.32] JOG operation acceleration time selection.
1ABDH	JOG deceleration time selection setting error	A value outside the setting range is set in [Pr.33] JOG operation deceleration time selection of detailed parameter 2. [Operation of when the error has occurred] ■At power-on or at turning on of [Cd.190] PLC READY signal Check that READY signal ([Md.140] Module status: b0) does not turn on. ■At the start of operation The operation is not performed.	Correct the value within the setting range and turn on [Cd.190] PLC READY signal if the signal is off. For details, refer to  Page 406 [Pr.33] JOG operation deceleration time selection.
1ABEH	Acceleration/ deceleration processing selection setting error	A value outside the setting range is set in [Pr.34] Acceleration/deceleration processing selection of detailed parameter 2. [Operation of when the error has occurred] ■At power-on or at turning on of [Cd.190] PLC READY signal Check that READY signal ([Md.140] Module status: b0) does not turn on. ■At the start of operation The operation is not performed.	Correct the value within the setting range and turn on [Cd.190] PLC READY signal if the signal is off. For details, refer to  Page 406 [Pr.34] Acceleration/ deceleration processing selection.
1ABFH	S-curve ratio setting error	A value outside the setting range is set in [Pr.35] S-curve ratio of detailed parameter 2. [Operation of when the error has occurred] ■At power-on or at turning on of [Cd.190] PLC READY signal Check that READY signal ([Md.140] Module status: b0) does not turn on. ■At the start of operation The operation is not performed.	Correct the value within the setting range and turn on [Cd.190] PLC READY signal if the signal is off. For details, refer to  Page 407 [Pr.35] S-curve ratio.
1AC0H	Illegal sudden stop deceleration time	A value outside the setting range is set in [Pr.36] Sudden stop deceleration time of detailed parameter 2. [Operation of when the error has occurred] ■At power-on or at turning on of [Cd.190] PLC READY signal Check that READY signal ([Md.140] Module status: b0) does not turn on. ■At the start of operation The operation is not performed.	Correct the value within the setting range and turn on [Cd.190] PLC READY signal if the signal is off. For details, refer to  Page 408 [Pr.36] Sudden stop deceleration time.
1AC1H	Stop group 1 sudden stop selection error	A value outside the setting range is set in [Pr.37] Stop group 1 sudden stop selection of detailed parameter 2. [Operation of when the error has occurred] ■At power-on or at turning on of [Cd.190] PLC READY signal Check that READY signal ([Md.140] Module status: b0) does not turn on. ■At the start of operation The operation is not performed.	Correct the value within the setting range and turn on [Cd.190] PLC READY signal if the signal is off. For details, refer to  Page 409 [Pr.37] to [Pr.39] Stop group 1 to 3 sudden stop selection.
1AC2H	Stop group 2 sudden stop selection error	A value outside the setting range is set in [Pr.38] Stop group 2 sudden stop selection of detailed parameter 2. [Operation of when the error has occurred] ■At power-on or at turning on of [Cd.190] PLC READY signal Check that READY signal ([Md.140] Module status: b0) does not turn on. ■At the start of operation The operation is not performed.	Correct the value within the setting range and turn on [Cd.190] PLC READY signal if the signal is off. For details, refer to  Page 409 [Pr.37] to [Pr.39] Stop group 1 to 3 sudden stop selection.

Error code	Error name	Cause and description	Action
1AC3H	Stop group 3 sudden stop selection error	A value outside the setting range is set in [Pr.39] Stop group 3 sudden stop selection of detailed parameter 2. [Operation of when the error has occurred] ■At power-on or at turning on of [Cd.190] PLC READY signal Check that READY signal ([Md.140] Module status: b0) does not turn on. ■At the start of operation The operation is not performed.	Correct the value within the setting range and turn on [Cd.190] PLC READY signal if the signal is off. For details, refer to  Page 409 [Pr.37] to [Pr.39] Stop group 1 to 3 sudden stop selection.
1AC4H	Outside allowance circular interpolation error width	A value outside the setting range is set in [Pr.41] Allowable circular interpolation error width of detailed parameter 2. [Operation of when the error has occurred] ■At power-on or at turning on of [Cd.190] PLC READY signal Check that READY signal ([Md.140] Module status: b0) does not turn on. ■At the start of operation The operation is not performed.	Correct the value within the setting range and turn on [Cd.190] PLC READY signal if the signal is off. For details, refer to  Page 411 [Pr.41] Allowable circular interpolation error width.
1AC5H	External command function selection error	A value outside the setting range is set in [Pr.42] External command function selection of detailed parameter 2. [Operation of when the error has occurred] ■At power-on or at turning on of [Cd.190] PLC READY signal Check that READY signal ([Md.140] Module status: b0) does not turn on. ■At the start of operation The operation is not performed.	Correct the value within the setting range and turn on [Cd.190] PLC READY signal if the signal is off. For details, refer to  Page 412 [Pr.42] External command function selection.
1AC7H	Outside start adjustment time error	A value outside the setting range is set in [Pr.82] Start adjustment time of detailed parameter 2. [Operation of when the error has occurred] ■At power-on or at turning on of [Cd.190] PLC READY signal Check that READY signal ([Md.140] Module status: b0) does not turn on. ■At the start of operation The operation is not performed.	Correct the value within the setting range and turn on [Cd.190] PLC READY signal if the signal is off. For details, refer to  Page 412 [Pr.82] Start adjustment time.
■Error at OPR parameter setting range check			
1B00H	OPR method error	A value outside the setting range is set in [Pr.43] OPR method of OPR basic parameter. [Operation of when the error has occurred] Check that READY signal ([Md.140] Module status: b0) does not turn on.	Configure the value so that it is within the setting range and then turn on [Cd.190] PLC READY signal. For details, refer to  Page 413 [Pr.43] OPR method.
1B01H	OPR direction error	A value outside the setting range is set in [Pr.44] OPR direction of OPR basic parameter. [Operation of when the error has occurred] Check that READY signal ([Md.140] Module status: b0) does not turn on.	Configure the value so that it is within the setting range and then turn on [Cd.190] PLC READY signal. For details, refer to  Page 414 [Pr.44] OPR direction.
1B02H	OP address setting error	A value outside the setting range is set in [Pr.45] OP address of OPR basic parameter. [Operation of when the error has occurred] Check that READY signal ([Md.140] Module status: b0) does not turn on.	Configure the value so that it is within the setting range and then turn on [Cd.190] PLC READY signal. For details, refer to  Page 415 [Pr.45] OP address.
1B03H	OPR speed error	A value outside the setting range is set in [Pr.46] OPR speed of OPR basic parameter. [Operation of when the error has occurred] Check that READY signal ([Md.140] Module status: b0) does not turn on.	Configure the value so that it is within the setting range and then turn on [Cd.190] PLC READY signal. For details, refer to  Page 415 [Pr.46] OPR speed.
1B04H	OPR speed error	A value set in [Pr.46] OPR speed of OPR basic parameter is over [Pr.8] Speed limit value. [Operation of when the error has occurred] Check that READY signal ([Md.140] Module status: b0) does not turn on.	Correct the value so that [Pr.46] OPR speed is equal to or below [Pr.8] Speed limit value, and turn on [Cd.190] PLC READY signal. For details, refer to the following.  Page 394 [Pr.8] Speed limit value  Page 415 [Pr.46] OPR speed

Error code	Error name	Cause and description	Action
1B05H	OPR speed error	A value set in [Pr.46] OPR speed of OPR basic parameter is below [Pr.7] Bias speed at start. [Operation of when the error has occurred] Check that READY signal ([Md.140] Module status: b0) does not turn on.	Correct the value so that [Pr.46] OPR speed is equal to or over [Pr.7] Bias speed at start, and turn on [Cd.190] PLC READY signal. For details, refer to the following. ☞ Page 391 [Pr.7] Bias speed at start ☞ Page 415 [Pr.46] OPR speed
1B06H	Creep speed error	A value outside the setting range is set in [Pr.47] Creep speed of OPR basic parameter. [Operation of when the error has occurred] Check that READY signal ([Md.140] Module status: b0) does not turn on.	Configure the value so that it is within the setting range and then turn on [Cd.190] PLC READY signal. For details, refer to ☞ Page 416 [Pr.47] Creep speed.
1B07H	Creep speed error	A value set in [Pr.47] Creep speed of OPR basic parameter is over [Pr.46] OPR speed. [Operation of when the error has occurred] Check that READY signal ([Md.140] Module status: b0) does not turn on.	Correct the value so that [Pr.47] Creep speed is equal to or below [Pr.46] OPR speed, and turn on [Cd.190] PLC READY signal. For details, refer to the following. ☞ Page 415 [Pr.46] OPR speed ☞ Page 416 [Pr.47] Creep speed
1B08H	Creep speed error	A value set in [Pr.47] Creep speed of OPR basic parameter is below [Pr.7] Bias speed at start. [Operation of when the error has occurred] Check that READY signal ([Md.140] Module status: b0) does not turn on.	Correct the value so that [Pr.46] OPR speed is equal to or over [Pr.7] Bias speed at start, and turn on [Cd.190] PLC READY signal. For details, refer to the following. ☞ Page 391 [Pr.7] Bias speed at start ☞ Page 416 [Pr.47] Creep speed
1B09H	OPR retry error	A value outside the setting range is set in [Pr.48] OPR retry of OPR basic parameter. [Operation of when the error has occurred] Check that READY signal ([Md.140] Module status: b0) does not turn on.	Configure the value so that it is within the setting range and then turn on [Cd.190] PLC READY signal. For details, refer to ☞ Page 417 [Pr.48] OPR retry.
1B0AH	Setting for the movement amount after near-point dog ON error	A value outside the setting range is set in [Pr.50] Setting for the movement amount after near-point dog ON of OPR detailed parameter. [Operation of when the error has occurred] Check that READY signal ([Md.140] Module status: b0) does not turn on.	Configure the value so that it is within the setting range and then turn on [Cd.190] PLC READY signal. For details, refer to ☞ Page 418 [Pr.50] Setting for the movement amount after near-point dog ON.
1B0BH	OPR acceleration time selection error	A value outside the setting range is set in [Pr.51] OPR acceleration time selection of OPR detailed parameter. [Operation of when the error has occurred] Check that READY signal ([Md.140] Module status: b0) does not turn on.	Configure the value so that it is within the setting range and then turn on [Cd.190] PLC READY signal. For details, refer to ☞ Page 419 [Pr.51] OPR acceleration time selection.
1B0CH	OPR deceleration time selection error	A value outside the setting range is set in [Pr.52] OPR deceleration time selection of OPR detailed parameter. [Operation of when the error has occurred] Check that READY signal ([Md.140] Module status: b0) does not turn on.	Configure the value so that it is within the setting range and then turn on [Cd.190] PLC READY signal. For details, refer to ☞ Page 419 [Pr.52] OPR deceleration time selection.
1B0DH	OPR torque limit value error	A value outside the setting range is set in [Pr.54] OPR torque limit value of OPR detailed parameter. [Operation of when the error has occurred] Check that READY signal ([Md.140] Module status: b0) does not turn on.	Configure the value so that it is within the setting range and then turn on [Cd.190] PLC READY signal. For details, refer to ☞ Page 421 [Pr.54] OPR torque limit value.
1B0EH	OPR torque limit value error	[Pr.54] OPR torque limit value of OPR detailed parameter is over [Pr.17] Torque limit setting value of detailed parameter 1. [Operation of when the error has occurred] Check that READY signal ([Md.140] Module status: b0) does not turn on.	Configure the value so that it is within the setting range and then turn on [Cd.190] PLC READY signal. For details, refer to the following. ☞ Page 399 [Pr.17] Torque limit setting value ☞ Page 421 [Pr.54] OPR torque limit value
1B0FH	Deviation counter clear signal output time setting error	A value outside the setting range is set in [Pr.55] Deviation counter clear signal output time of OPR detailed parameter. [Operation of when the error has occurred] Check that READY signal ([Md.140] Module status: b0) does not turn on.	Configure the value so that it is within the setting range and then turn on [Cd.190] PLC READY signal. For details, refer to ☞ Page 421 [Pr.55] Deviation counter clear signal output time.
1B10H	Speed specification during OP shift error	A value outside the setting range is set in [Pr.56] Speed specification during OP shift of OPR detailed parameter. [Operation of when the error has occurred] Check that READY signal ([Md.140] Module status: b0) does not turn on.	Configure the value so that it is within the setting range and then turn on [Cd.190] PLC READY signal. For details, refer to ☞ Page 421 [Pr.56] Speed specification during OP shift.

Error code	Error name	Cause and description	Action
1B11H	Setting of operation during uncompleted OPR	A value outside the setting range is set in [Pr.58] Setting of operation during uncompleted OPR of OPR detailed parameter. [Operation of when the error has occurred] Check that READY signal ([Md.140] Module status: b0) does not turn on.	Configure the value so that it is within the setting range and then turn on [Cd.190] PLC READY signal. For details, refer to  Page 422 [Pr.58] Setting of operation during uncompleted OPR.
■H/W error			
3001H	Fault	Hardware failure [Operation of when the error has occurred] The operation stops immediately.	Check for noise influence.
3002H	Internal circuit fault	Hardware failure [Operation of when the error has occurred] The operation stops immediately.	Check for noise influence.
3020H	CPU module error	An error was detected in the CPU module. [Operation of when the error has occurred] The operation stops slowly.	Check the error of the CPU module and take corrective action using the module diagnostics.
3022H	System bus error	The communication with a CPU module failed. [Operation of when the error has occurred] The system stops.	<ul style="list-style-type: none"> • Check for noise influence. • Check for connecting the expansion cable.

APPENDIX

Appendix 1 Dimensions Diagram

Shows the external dimensions of the positioning module.

FX5-20PG-P

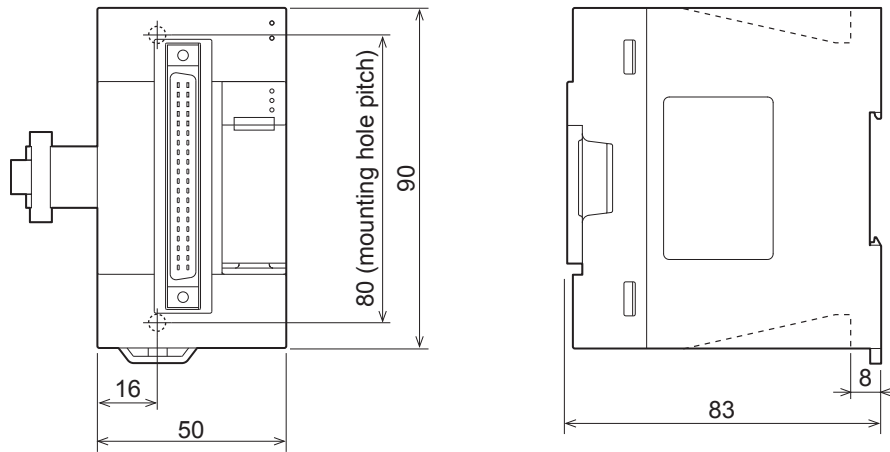

(Unit: mm)

FX5-20PG-D

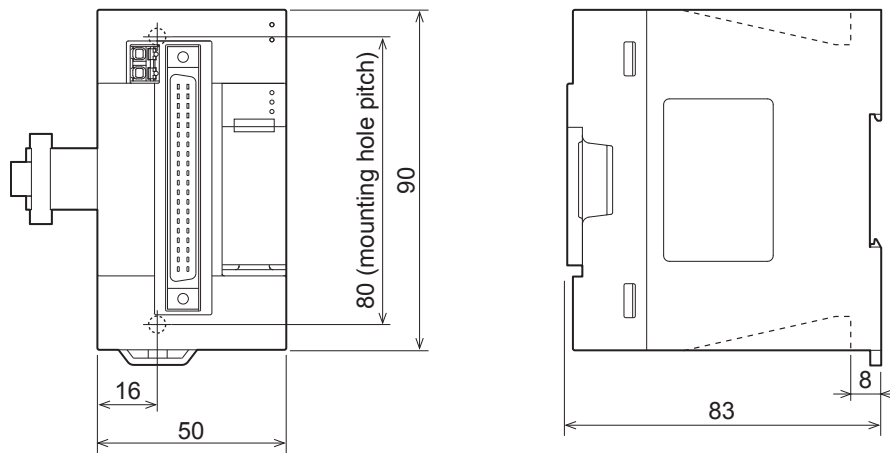

(Unit: mm)

Appendix 2 Standards

Certification of UL, cUL standards

The positioning module supports UL (UL, cUL) standards.
For models that support UL standards, refer to the following.
UL, cUL file number: E95239

Compliance with EC directive (CE Marking)

This note does not guarantee that an entire machine produced in accordance with the contents of this note will comply with the following standards.

Compliance to EMC directive and LVD directive of the entire mechanical module should be checked by the user/ manufacturer. For more details please contact to the local Mitsubishi Electric sales site.

Requirement for compliance with EMC directive

The following products have shown compliance through direct testing (of the identified standards below) and design analysis (through the creation of a technical construction file) to the European Directive for Electromagnetic Compatibility (2014/30/ EU) when used as directed by the appropriate documentation.

Attention

This product is designed for use in industrial applications.

Product compatibility

Type: Programmable controller (open type equipment)

Models: FX5 manufactured

from April 1st, 2017	FX5-20PG-P
from October 1st, 2018	FX5-20PG-D

Electromagnetic compatibility (EMC) directive	Remarks
EN61131-2:2007 Programmable controllers - Equipment requirements and tests	Compliance with all relevant aspects of the standard. EMI • Radiated emission • Conducted emission EMS • Radiated electromagnetic field • Fast transient burst • Electrostatic discharge • High-energy surge • Voltage drops and interruptions • Conducted RF • Power frequency magnetic field

A

Caution for compliance with EC Directive

Caution for when the positioning module is used

When the positioning module is used, attach a ferrite core to the power supplies of the CPU module and the positioning module.

Make 2 turns around the ferrite core and attach within approximately 200 mm from the terminal block and connectors of the power cable. (Ferrite core used in Mitsubishi Electric's test: E04SR401938 manufactured by SEIWA ELECTRIC MFG. CO., LTD.)

The power lines connected to the module power terminals from the external power supply and 24 V DC service power supply and the control signal lines (input signals) must be 30 m or less in length.

Caution for when the control signal line is used

For the control signal line, use a shielded cable and ground to both sides of the cable. Strip a part of the jacket of the cable as shown below and ground the exposed shield as much as possible.

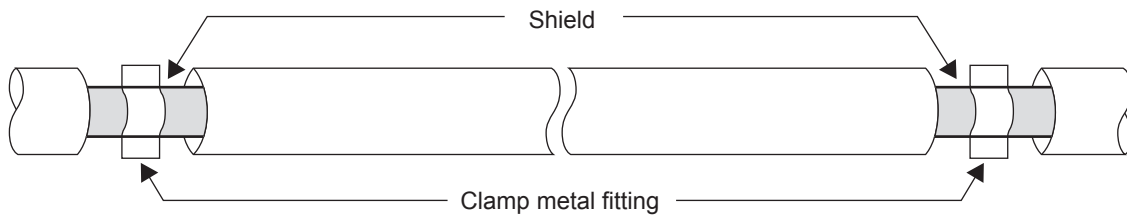

Appendix 3 Module Label

The functions of the positioning module can be set by using module labels.

Module label of I/O signals

The label names of I/O signals are defined with the following configuration.

- "Module name"_"Module number".bPLCReady_D
- "Module name"_"Module number".stSystemMonitorData2_D.b"Label name"_D
- "Module name"_"Module number".stSystemMonitorData2_D.bnBusy_"Axis_D[ax]"
- "Module name"_"Module number".stnAxisMonitorData_"Axis_D[ax]".b"Label name"_D
- "Module name"_"Module number".stnAxisControlData2_"Axis_D[ax]". "Data type""Label name"_D

■Module name

The module name indicates the model of the module.

■Module number

The module number starts from one and is added for identifying modules with the same module name.

■Label name

The label name is unique for each module.

■Axis [ax]

Axis [ax] indicates the axis number corresponding to the module label. A numerical value from 0 to 1 is used for [ax] according to the axis from 1 to 2. (Axis 1: 0, axis 2: 1)

■Data type

The data type indicates the size of a buffer memory area. The following shows the classification.

Data Type	Description
b	Bit
u	Word [Unsigned]/Bit String [16-bit]

■_D

_D indicates that the module label is for direct access.

Type	Description	Access timing	Example
Direct access	Values that has been read from or written to module labels are immediately applied to the module. The execution time is longer than the one at auto refresh, but the responsiveness is high.	At reading/writing data from/to the module label	FX5PG_1.bPLCReady_D

Module label of buffer memory areas

The names of the module labels of the buffer memory areas are defined with the following configuration.

- "Module name"_"Module number"."Data type"_D"."Data format""Label name"_D
- "Module name"_"Module number"."Data type"_D"."Data format""Label name"_D.[Bit No.]
- "Module name"_"Module number"."Data type"_D"."Data format""Label name"_ "Axis_D[ax]"
- "Module name"_"Module number"."Data type"_ "Axis_D[ax]". "Data type""Label name"_D

■Module name

The module name indicates the model of the module.

■Module number

The module number starts from one and increments for identifying modules with the same module name.

■Data type

The data type indicates the type of a buffer memory area. The following shows the classification.

Data type	Description
stnParameter	Indicates the basic setting.
stnAxisMonitorData	Indicates the axis monitor data.
stnAxisControlData	Indicates the axis control data.
stSystemControlData	Indicates the system control data.
stInterruptSettingData	Indicates the system monitor data.

■Label name

The label name is unique for each module.

■Axis [ax]

Axis [ax] indicates the axis number corresponding to the module label. A numerical value from 0 to 1 is used for [ax] according to the axis from 1 to 2. (Axis 1: 0, axis 2: 1)

■Data type

The data type indicates the size of a buffer memory area. The following shows the classification.

Data Type	Description
u	Word [Unsigned]/Bit String [16-bit]
w	Word [Signed]
ud	Double Word [Unsigned]/Bit String [32-bit]
d	Double Word [Signed]

■_D

_D indicates that the module label is for direct access.

Type	Description	Access timing	Example
Direct access	Values that has been read from or written to module labels are immediately applied to the module. The execution time is longer than the one at auto refresh, but the responsiveness is high.	At reading/writing data from/to the module label	FX5PG_1.stnAxisMonitorData_Axis_D[0].dCurrentFeedValue_D

Appendix 4 Dedicated Instruction

The following table lists dedicated instructions.

Application	Dedicated instruction	Function overview
Absolute position restoration	G.ABRST1	Restores the absolute position of a specified axis of the positioning module.
	G.ABRST2	
Positioning start	GP.PSTR1	Starts the positioning control of a specified axis of the positioning module.
	GP.PSTR2	
Teaching	GP.TEACH1	Performs teaching of a specified axis of the positioning module.
	GP.TEACH2	
Module data backup	GP.PFWRT	Writes module extension parameters (positioning data and block start data) in the buffer memory to the module extension parameter file.
Module data initialization	GP.PINIT	Sets module parameters and module extension parameters (positioning data and block start data) in the buffer memory and setting values in the module extension parameter file to their factory default settings.

For details on the dedicated instructions, refer to the following.

 MELSEC iQ-F FX5 Programming Manual (Instructions, Standard Functions/Function Blocks)

Appendix 5 How to Find Buffer Memory Addresses

This section describes how to find the buffer memory addresses of positioning data, block start data, and condition data.

Positioning data

Positioning data No. 1 to No. 600 are assigned to each axis. Positioning data has the following structure.

		1	2	3	...	599	600
Axis 1	Positioning data No.	1	2	3	...	599	600
	Positioning identifier [Da.1] to [Da.5]	2000	2010	2020	...	7980	7990
	[Da.10] M code	2001	2011	2021	...	7981	7991
	[Da.9] Dwell time	2002	2012	2022	...	7982	7992
	Positioning option [Da.27] to [Da.29]	2003	2013	2023	...	7983	7993
	[Da.8] Command speed	2004 2005	2014 2015	2024 2025	...	7984 7985	7994 7995
	[Da.6] Positioning address/movement amount	2006 2007	2016 2017	2026 2027	...	7986 7987	7996 7997
[Da.7] Arc address	2008 2009	2018 2019	2028 2029	...	7988 7989	7998 7999	

- A maximum of 600 positioning data can be stored for each axis in the buffer memory address described on the left. This data is managed as positioning data No. 1 to 600 for each axis.
- One positioning data is configured using items.

		1	2	3	...	599	600
Axis 2	Positioning data No.	1	2	3	...	599	600
	Positioning identifier [Da.1] to [Da.5]	8000	8010	8020	...	13980	13990
	[Da.10] M code	8001	8011	8021	...	13981	13991
	[Da.9] Dwell time	8002	8012	8022	...	13982	13992
	Positioning option [Da.27] to [Da.29]	8003	8013	8023	...	13983	13993
	[Da.8] Command speed	8004 8005	8014 8015	8024 8025	...	13984 13985	13994 13995
	[Da.6] Positioning address/movement amount	8006 8007	8016 8017	8026 8027	...	13986 13987	13996 13997
[Da.7] Arc address	8008 8009	8018 8019	8028 8029	...	13988 13989	13998 13999	

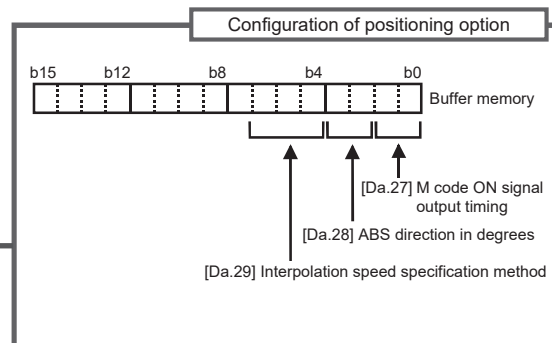
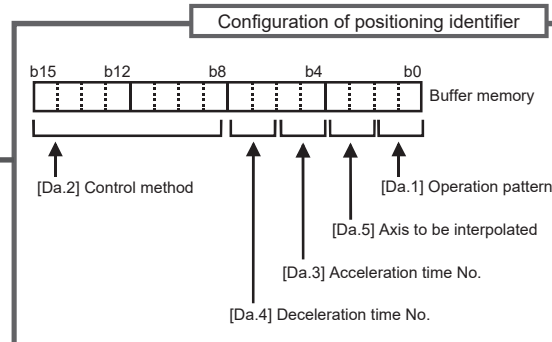

When setting positioning data using a program, determine buffer memory addresses using the following calculation formula and set the addresses.

$$\bullet 2000+6000 \times(Ax-1)+10 \times(N-1)+S$$

For each variable, substitute a number following the description below.

Item	Description
Ax	The axis number of the buffer memory address to be determined. Substitute a number from 1 to 2.
N	The positioning data No. of the buffer memory address to be determined. Substitute a number from 1 to 600.
S	Substitute one of the following numbers according to the buffer memory address to be determined. <ul style="list-style-type: none"> • Positioning identifier ([Da.1] to [Da.5]): 0 • [Da.10] M code: 1 • [Da.9] Dwell time: 2 • Positioning option ([Da.27] to [Da.29]): 3 • [Da.8] Command speed (lower 16 bits): 4 • [Da.8] Command speed (upper 16 bits): 5 • [Da.6] Positioning address/movement amount (lower 16 bits): 6 • [Da.6] Positioning address/movement amount (upper 16 bits): 7 • [Da.7] Arc address (lower 16 bits): 8 • [Da.7] Arc address (upper 16 bits): 9

Ex.

When the buffer memory address of [Da.9] Dwell time of the positioning data No.200 of axis 2 is determined

$$2000+6000 \times(2-1)+10 \times(200-1)+2=9992$$



Block start data

Block start data consists of five start blocks from Start block 0 to 4, and the block start data of 1 to 50 points is assigned to each block. The start blocks are assigned to each axis. Block start data has the following structure.

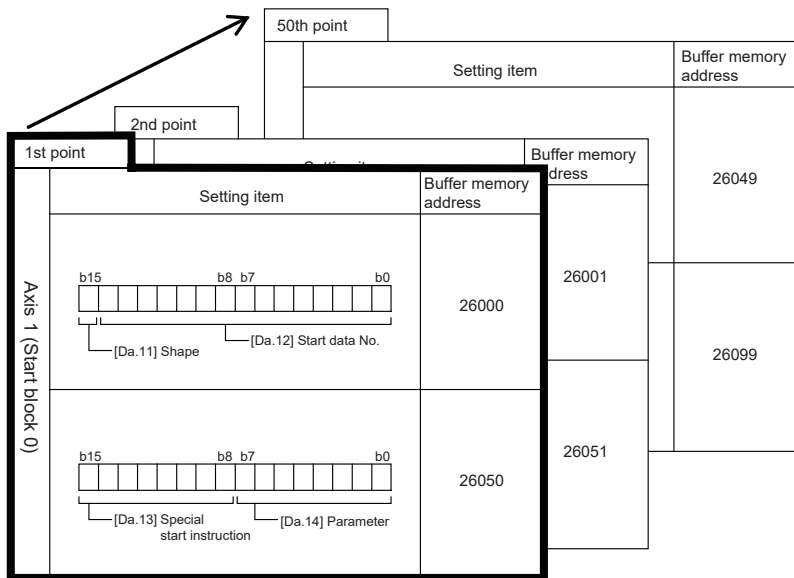

- A maximum of 50 block start data points can be set (stored) for each axis in the buffer memory address described on the left.
- One block start data is configured using items.
- Configured using 5 blocks of 0 to 4 start blocks for each axis.

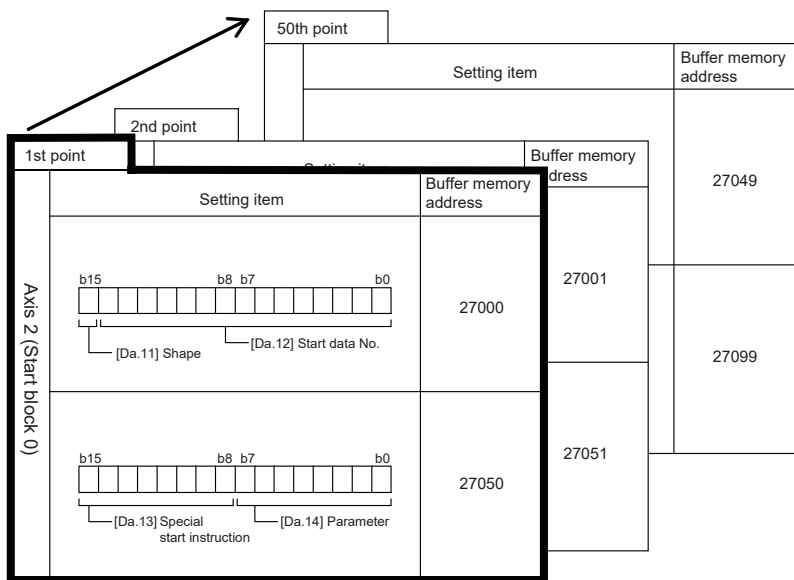

When setting block start data using a program, determine buffer memory addresses using the following calculation formula and set the addresses.

■ Calculation formula for [Da.11] Shape and [Da.12] Start data No.

Use the following calculation formula.

- $26000+(1000 \times (Ax-1))+(200 \times M)+(P-1)$

For each variable, substitute a number following the description below.

Item	Description
Ax	The axis number of the buffer memory address to be determined. Substitute a number from 1 to 2.
M	The start block No. of the buffer memory address to be determined. Substitute a number from 0 to 4.
P	The block start data point of the buffer memory address to be determined. Substitute a number from 1 to 50.

Ex.

When the buffer memory address that satisfies the following conditions is determined

- Axis 2
- Start block No.2
- Block start data point: 40

$$26000+(1000 \times (2-1))+(200 \times 2)+(40-1)=27439$$

■ Calculation formula for [Da.13] Special start instruction and [Da.14] Parameter

Use the following calculation formula.

- $26050+(1000 \times (Ax-1))+(200 \times M)+(P-1)$

For each variable, substitute a number following the description below.

Item	Description
Ax	The axis number of the buffer memory address to be determined. Substitute a number from 1 to 2.
M	The start block No. of the buffer memory address to be determined. Substitute a number from 0 to 4.
P	The block start data point of the buffer memory address to be determined. Substitute a number from 1 to 50.

Ex.

When the buffer memory address that satisfies the following conditions is determined

- Axis 2
- Start block No.1
- Block start data point: 25

$$26050+(1000 \times (2-1))+(200 \times 1)+(25-1)=27274$$



Condition data

Condition data consists of five start blocks from Start block 0 to 4, and the condition data No.1 to 10 are assigned to each block. The start blocks are assigned to each axis. Condition data has the following structure.

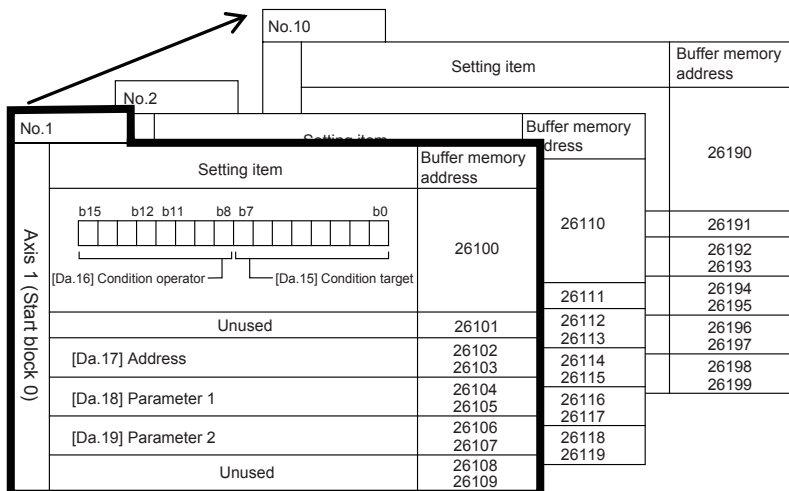

- A maximum of 10 conditions data can be set (stored) for each block number in the buffer memory address described on the left.
- One condition data is configured using items.
- Configured using 5 blocks of 0 to 4 start blocks for each axis.

When setting block start data using a program, determine buffer memory addresses using the following calculation formula and set the addresses.

$$\bullet 26100+(1000 \times(Ax-1))+(200 \times M)+(10 \times(Q-1))+R$$

For each variable, substitute a number following the description below.

Item	Description
Ax	The axis number of the buffer memory address to be determined. Substitute a number from 1 to 2.
M	The start block No. of the buffer memory address to be determined. Substitute a number from 0 to 4.
Q	The condition data No. of the buffer memory address to be determined. Substitute a number from 1 to 10.
R	Substitute one of the following numbers according to the buffer memory address to be determined. <ul style="list-style-type: none"> • [Da. 15] Condition target: 0 • [Da. 16] Condition operator: 0 • [Da. 17] Address (lower 16 bits): 2 • [Da. 17] Address (upper 16 bits): 3 • [Da. 18] Parameter 1 (lower 16 bits): 4 • [Da. 18] Parameter 1 (upper 16 bits): 5 • [Da. 19] Parameter 2 (lower 16 bits): 6 • [Da. 19] Parameter 2 (upper 16 bits): 7

Ex.

When the buffer memory address that satisfies the following conditions is determined

- Axis 2
- Start block No.3
- Condition data No. 5
- [Da.19] Parameter 2 (lower 16 bits)

$$26100+(1000 \times(2-1))+(200 \times 3)+(10 \times(5-1))+6=27746$$

Appendix 7 Configuration Device List

The positioning system, which uses the positioning module, is configured using the following devices.

No.	Product	Model	Remarks
1	Positioning module	FX5-20PG-P FX5-20PG-D	FX5-20PG-  <ul style="list-style-type: none"> • P..... Transistor output system • D..... Differential driver output system
2	Drive unit	—	Servo amplifier, etc.
3	Manual pulse generator (manual pulse emitter)	—	Recommended: MR-HDP01 (Mitsubishi Electric)
4	Connector cable	—	The cable for connecting the positioning module and the drive unit, manual pulse generator, and mechanical input signals.
5	Connector for connecting external devices	A6CON1	Soldered type (straight protrusion)
		A6CON2	Crimped type
		A6CON4	Soldered type (for both straight / inclined protrusion)

Appendix 8 Precautions for Using a Stepping Motor

Describes the precautions for using a stepping motor.

For S-curve acceleration/deceleration

Implementing the S-curve acceleration/deceleration may cause step out in the axis connected to the stepping motor. Before using the S-curve acceleration/deceleration, check that step out does not occur.

For circular interpolation control

The axis connected to the stepping motor cannot use circular interpolation control. Use a servomotor is implementing circular interpolation control.

For backlash compensation function

The backlash compensation function cannot be used for an axis where a stepping motor is connected. If using the backlash compensation function, there is a risk that the motor will step out.

Appendix 9 Added and Enhanced Functions

The functions added or changed with the positioning module and engineering tool, and supported firmware version of the positioning module and CPU module, and engineering tool software version are given below.

The firmware version of positioning module can be confirmed with buffer memory. (☞ Page 442 [Md.130] Firmware version)

The firmware version of CPU module can be confirmed with module diagnosis (CPU diagnosis). Refer to the following manuals for details on diagnosing the module (CPU diagnosis).

☞ MELSEC iQ-F FX5UJ User's Manual (Hardware)

☞ MELSEC iQ-F FX5U User's Manual (Hardware)

☞ MELSEC iQ-F FX5UC User's Manual (Hardware)

Refer to the ☞ GX Works3 Operating Manual for details on the software version.

FX5UJ CPU module

Add/Change Function	Supported version			Reference
	CPU module firmware version	Positioning module firmware version	Engineering tool	
Support FX5-20PG-D	From the first	—	"1.060N" and above	—
Support OPR method "Limit switch combined-use method"	From the first	"1.010" and above	"1.060N" and above	Page 98
Support external I/O signal monitor function	From the first	"1.010" and above	"1.060N" and above	Page 315
Support event history function	From the first	"1.010" and above	"1.060N" and above	Page 317

FX5U/FX5UC CPU module

Add/Change Function	Supported version			Reference
	CPU module firmware version	Positioning module firmware version	Engineering tool	
Support FX5-20PG-D	"1.050" and above	—	"1.050C" and above	—
Support OPR method "Limit switch combined-use method"	—	"1.010" and above	"1.050C" and above	Page 98
Support external I/O signal monitor function	—	"1.010" and above	"1.050C" and above	Page 315
Support event history function	"1.040" and above*1	"1.010" and above	"1.050C" and above	Page 317

*1 Saving the event history file to the SD card is supported from CPU module serial No. 16Y**** and later.



INDEX

Symbols

- [Cd.1] Module data backup request 466
- [Cd.10] New acceleration time value 472
- [Cd.11] New deceleration time value 472
- [Cd.12] Acceleration/deceleration time change during speed change, enable/disable selection. . 473
- [Cd.13] Positioning operation speed override . . . 473
- [Cd.137] Amplifier-less operation mode switching request 469
- [Cd.14] New speed value 473
- [Cd.15] Speed change request 474
- [Cd.16] Inching movement amount 474
- [Cd.17] JOG speed 474
- [Cd.18] Continuous operation interrupt request. . 475
- [Cd.180] Axis stop signal 482
- [Cd.181] Forward JOG start signal 482
- [Cd.182] Reverse JOG start signal 482
- [Cd.183] Execution prohibition flag 483
- [Cd.184] Positioning start signal 483
- [Cd.19] OPR request flag OFF request 475
- [Cd.190] PLC READY signal 469
- [Cd.2] Module data initialization request 467
- [Cd.20] Manual pulse generator 1 pulse input magnification 475
- [Cd.21] Manual pulse generator enable flag 476
- [Cd.22] New torque value. 476
- [Cd.23] Speed-position switching control movement amount change register. 476
- [Cd.24] Speed-position switching enable flag . . . 477
- [Cd.25] Position-speed switching control speed change register. 477
- [Cd.26] Position-speed switching enable flag . . . 477
- [Cd.27] Target position change value (new address) 478
- [Cd.28] Target position change value (new speed) 478
- [Cd.29] Target position change request flag 478
- [Cd.3] Positioning start No. 470
- [Cd.30] Simultaneous starting axis start data No. (Axis 1 start data No.) 479
- [Cd.31] Simultaneous starting axis start data No. (Axis 2 start data No.) 479
- [Cd.34] Step mode 479
- [Cd.35] Step valid flag 479
- [Cd.36] Step start request 480
- [Cd.37] Skip command 480
- [Cd.38] Teaching data selection 480
- [Cd.39] Teaching positioning data No. 480
- [Cd.4] Positioning starting point No. 470
- [Cd.40] ABS direction in degrees 481
- [Cd.41] Deceleration start flag valid. 467
- [Cd.42] Stop command processing for deceleration stop selection 467
- [Cd.43] Analysis mode setting 482
- [Cd.43] Output timing selection of near pass control 468
- [Cd.44] External input signal operation device . . 468
- [Cd.45] Speed \leftrightarrow position switching device selection 481
- [Cd.46] Speed \leftrightarrow position switching command. . . 481
- [Cd.49] All axes error reset. 468
- [Cd.5] Axis error reset 470
- [Cd.50] Interrupt factor mask 484
- [Cd.51] Interrupt factor reset request. 484
- [Cd.6] Restart command 471
- [Cd.7] M code ON signal OFF request 471
- [Cd.8] External command valid. 471
- [Cd.9] New current value 472
- [Da.1] Operation pattern 424
- [Da.10] M code. 432
- [Da.11] Shape 435
- [Da.12] Start data No. 436
- [Da.13] Special start instruction 436
- [Da.14] Parameter 437
- [Da.15] Condition target. 438
- [Da.16] Condition operator. 439
- [Da.17] Address 439
- [Da.18] Parameter 1 440
- [Da.19] Parameter 2 441
- [Da.2] Control method 425
- [Da.27] M code ON signal output timing 432
- [Da.28] ABS direction in degrees 433
- [Da.29] Interpolation speed specification method . 433
- [Da.3] Acceleration time No. 426
- [Da.4] Deceleration time No. 426
- [Da.5] Axis to be interpolated 426
- [Da.6] Positioning address/movement amount . . . 427
- [Da.7] Arc address 429
- [Da.8] Command speed. 430
- [Da.9] Dwell time 431
- [Md.1] In test mode flag. 442
- [Md.10] Error No. 447
- [Md.11] Error occurrence (date/hour) 448
- [Md.13] Error history pointer. 448
- [Md.130] Firmware version 442
- [Md.14] Axis in which the warning occurred 449
- [Md.140] Module status 453
- [Md.141] BUSY signal 453
- [Md.15] Warning No. 449
- [Md.16] Warning occurrence (date/hour) 450
- [Md.17] Warning occurrence (minute/second) . . . 450
- [Md.18] Warning history pointer 450
- [Md.19] No. of write accesses to flash ROM. . . . 451
- [Md.20] Current feed value 454
- [Md.21] Machine feed value 454
- [Md.22] Feedrate 455
- [Md.23] Axis error No. 455
- [Md.24] Axis warning No. 455
- [Md.25] Valid M code 455
- [Md.26] Axis operation status 456
- [Md.27] Current speed. 456
- [Md.28] Axis feedrate 457
- [Md.29] Speed-position switching control positioning amount 457
- [Md.3] Start information 443
- [Md.30] External I/O signal. 458
- [Md.31] Status 458
- [Md.32] Target value 460
- [Md.33] Target speed 460
- [Md.34] Movement amount after near-point dog ON 461
- [Md.35] Torque limit stored value 462

[Md.36] Special start data instruction code setting value	462
[Md.37] Special start data instruction parameter setting value	462
[Md.38] Start positioning data No. setting value	462
[Md.39] In speed limit flag	463
[Md.4] Start No.	445
[Md.40] In speed change processing flag	463
[Md.41] Special start repetition counter	463
[Md.42] Control method repetition counter	463
[Md.43] Start data pointer being executed	464
[Md.44] Positioning data No. being executed	464
[Md.45] Block No. being executed	464
[Md.46] Last executed positioning data No.	464
[Md.47] Positioning data being executed	465
[Md.48] Deceleration start flag	466
[Md.5] Start (date/hour)	445
[Md.50] Start (year/month)	445
[Md.51] Error occurrence (year/month)	448
[Md.52] Warning occurrence (year/month)	450
[Md.53] Date of write accesses to flash ROM (year/month)	451
[Md.54] Date of write accesses to flash ROM (date/hour)	451
[Md.55] Date of write accesses to flash ROM (minute/second)	452
[Md.56] Date of write accesses to flash ROM (ms)	452
[Md.59] Module information	452
[Md.6] Start (minute/second)	446
[Md.60] Analysis mode	465
[Md.61] Analysis complete flag	465
[Md.63] OPR request flag ON factor	461
[Md.64] Positioning control complete factor	461
[Md.65] Interrupt factor detection flag	484
[Md.7] Error judgment	446
[Md.70] Amplifier-less operation mode status	466
[Md.8] Start history pointer	446
[Md.9] Axis in which the error occurred	447
[Pr.1] Unit setting	385
[Pr.10] Deceleration time 0	395
[Pr.11] Backlash compensation amount	396
[Pr.12] Software stroke limit upper limit value	397
[Pr.13] Software stroke limit lower limit value	397
[Pr.14] Software stroke limit selection	398
[Pr.15] Software stroke limit valid/invalid setting	398
[Pr.150] Speed-position function selection	403
[Pr.16] Command in-position width	398
[Pr.17] Torque limit setting value	399
[Pr.18] M code ON signal output timing	400
[Pr.19] Speed switching mode	400
[Pr.2] No. of pulses per rotation (16 bits) (Ap)	386
[Pr.2] No. of pulses per rotation (32 bits) (Ap)	392
[Pr.20] Interpolation speed specification method	401
[Pr.21] Current feed value during speed control	401
[Pr.22] Input signal logic selection	402
[Pr.23] Output signal logic selection	402
[Pr.24] Manual pulse generator input selection	403
[Pr.25] Acceleration time 1 to [Pr.27] Acceleration time 3	404
[Pr.28] Deceleration time 1 to [Pr.30] Deceleration time 3	404
[Pr.3] Movement amount per rotation (16 bits) (Al)	387
[Pr.3] Movement amount per rotation (32 bits)	393
[Pr.31] JOG speed limit value	405

[Pr.32] JOG operation acceleration time selection	405
[Pr.33] JOG operation deceleration time selection	406
[Pr.34] Acceleration/deceleration processing selection	406
[Pr.35] S-curve ratio	407
[Pr.36] Sudden stop deceleration time	408
[Pr.37] to [Pr.39] Stop group 1 to 3 sudden stop selection	409
[Pr.4] Unit magnification	387
[Pr.40] Positioning complete signal output time	410
[Pr.41] Allowable circular interpolation error width	411
[Pr.42] External command function selection	412
[Pr.43] OPR method	413
[Pr.44] OPR direction	414
[Pr.45] OP address	415
[Pr.46] OPR speed	415
[Pr.47] Creep speed	416
[Pr.48] OPR retry	417
[Pr.49] OPR dwell time	417
[Pr.5] Pulse output mode	388
[Pr.50] Setting for the movement amount after near-point dog ON	418
[Pr.51] OPR acceleration time selection	419
[Pr.52] OPR deceleration time selection	419
[Pr.53] OP shift amount	420
[Pr.54] OPR torque limit value	421
[Pr.55] Deviation counter clear signal output time	421
[Pr.56] Speed specification during OP shift	421
[Pr.57] Dwell time during OPR retry	422
[Pr.58] Setting of operation during uncompleted OPR	422
[Pr.6] Rotation direction setting	390
[Pr.62] Electronic gear selection	392
[Pr.7] Bias speed at start	391
[Pr.8] Speed limit value	394
[Pr.82] Start adjustment time	412
[Pr.9] Acceleration time 0	395
[Pr.900] Interrupt factor setting	485
[Pr.901] Axis No. for interrupt factor	485

0 to 9

1-axis linear control (ABS linear 1)	123
1-axis linear control (INC linear 1)	124
2-axis circular interpolation control with sub point specified (ABS circular sub)	131,137,139
2-axis circular interpolation control with sub point specified (INC circular sub)	133
2-axis linear interpolation control (ABS linear 2)	125
2-axis linear interpolation control (INC linear 2)	127

A

A phase/B phase mode	389
Absolute position restoration function	271
Absolute system	111
Acceleration/deceleration processing function	298
Acceleration/deceleration time change function	258
Advanced positioning control	174
AFTER mode	287
Amplifier-less operation function	319
Axis control data	470
Axis monitor data	454

B

Backlash compensation function	227
Basic parameter 1	385
Basic parameter 2	394
Basic parameter 3	486
Basic setting	385
Block start (normal start)	179
Block start data	434
Block start data setting items	364

C

Combining main and sub functions	34
Combining various sub functions	39
Command in-position function	296
Common function	309
Composite speed	401
Condition data	438
Condition start	181
Configuration of error history	447
Configuration of positioning identifier	424
Configuration of start history	444
Continuous operation interrupt function	278
Continuous path control	105
Continuous positioning control	105
Control data	466
Count method 1	93
Count method 2	95
Current feed value	112
Current value change	165
CW/CCW mode	388

D

Data setting method	97
Deceleration start flag function	300
Deceleration stop	74
Dedicated instruction	551
Detailed parameter 1	396
During uncompleted OPR operation setting function	302

E

Electronic gear function	228
Error compensation method	231
Event history function	317
Extended parameter storage setting	486
External I/O signal logic switching function	314
External I/O signal monitor function	315

F

Fast OPR	100
Fixed-feed control	129
Front-loading speed switching mode	110
Function related to start	266
Function related to stop	276
Function to compensate control	227
Function to limit control	237
Functions that change control details	250

H

Hardware stroke limit function	248
History monitor function	316

I

Immediate stop	74
Inching operation	194,204
Incremental system	111
Independent positioning control (positioning complete)	104
Input signal	350
Axis stop	352
BUSY	351
Error detection	351
Execution prohibition flag	352
Forward run JOG start	352
M code ON	351
Module access flag	351
PLC READY	352
Positioning complete	351
Positioning start	352
READY	351
Revers run JOG start	352
Start complete	351
Interpolation control	117
Interrupt function	303
Interrupt setting	484

J

JOG operation	194,196
JOG/manual pulse generator/OPR test	344
JUMP instruction	170

L

LEND	173
Limit switch combined-use method	98
List of buffer memory addresses	365
List of error codes	524
List of I/O signals with CPU module	350
List of warning codes	520
LOOP	172

M

M code output function	287
Machine feed value	112
Machine OPR	80
Major positioning control	102
Manual control	194
Manual pulse generator operation	195,211
Module data backup function	312
Module data initialization function	310
Module extension parameter	332
Module label	549
Module parameter	324
Monitor data	442
Movement amount per pulse	229,386
Multiple axes simultaneous start	71

N

Near pass function	233
Near-point dog method	83
NEXT start	186
NOP instruction	169
Normal start	65

O

OP shift function	224
OPR basic parameter	413
OPR control	79
OPR detailed parameter	417
OPR method	81
OPR retry function	220
Other control tests	349
Output signal	350
Output timing selection of near pass control	235
Override function	255

P

Positioning control test	342
Positioning data	423
Positioning monitor	339
Positioning test	340
Position-speed switching control	158
Precautions for using a stepping motor	560
Pre-reading start function	266
PROGRAMMING	491
PULSE/SIGN mode	388

Q

Quick start	66
-----------------------	----

R

Reference axis speed	401
Repeated start (FOR condition)	185
Repeated start (FOR loop)	184
Restarting	77

S

S-curve acceleration/deceleration processing method	299
Setting data	354
Setting items for condition data	364
Setting items for OPR parameters	361
Setting items for positioning data	362
Setting items for positioning parameters	356
Simultaneous start	183
Skip function	284
Software stroke limit function	242
Speed change function	250
Speed change test	347
Speed control	141
Speed limit function	237
Speed-position switching control (ABS mode)	152
Speed-position switching control (INC mode)	144
Standard speed switching mode	109
Start condition	62
Start time adjustment function	269
Starting	62

Step function	280
Stop command processing for deceleration stop function	276
Stopper method 1	85
Stopper method 2	88
Stopper method 3	91
Sub functions	218
Sub functions specific to machine OPR	220
Sudden stop	74
System control data	466
System monitor data	442

T

Target position change function	263
Teaching function	291
The combinations of the reference axis and interpolation axes	117
Torque change function	261
Torque limit function	239
Trapezoidal acceleration/deceleration processing method	298
Troubleshooting	512

V

Valid timing of setting data	354
--	-----

W

Wait start	182
Warning history configuration	449
WITH mode	287

REVISIONS

Revision date	Revision	Description
April, 2017	A	First Edition
September, 2017	B	<ul style="list-style-type: none"> ■ Added or modified parts TERMS, Section 18.3
October, 2018	C	<ul style="list-style-type: none"> ■ Added models FX5-20PG-D <ul style="list-style-type: none"> ■ Added functions Limit switch combined-use method, External I/O signal monitor function, Event history function <ul style="list-style-type: none"> ■ Added or modified parts SAFETY PRECAUTIONS, RELEVANT MANUALS, TERMS, Chapter 1, Section 2.2, 2.3, 2.4, 2.5, 4.4, Chapter 5, Section 6.2, 6.4, 8.2, 11.3, 11.4, 12.2, 12.3, 12.4, 13.1, 13.5, 13.7, 16.4, 17.1, 17.3, 17.7, 19.1, 19.5, Appendix 1, 2, 6, 7, 9, TRADEMARKS
October, 2019	D	<ul style="list-style-type: none"> ■ Added models FX5UJ CPU module <ul style="list-style-type: none"> ■ Added or modified parts RELEVANT MANUALS, TERMS, Section 2.1, 2.3, Chapter 3, 5, Section 19.1, Appendix 9, TRADEMARKS

This manual confers no industrial property rights or any rights of any other kind, nor does it confer any patent licenses. Mitsubishi Electric Corporation cannot be held responsible for any problems involving industrial property rights which may occur as a result of using the contents noted in this manual.

© 2017 MITSUBISHI ELECTRIC CORPORATION

WARRANTY

Please confirm the following product warranty details before using this product.

1. Gratis Warranty Term and Gratis Warranty Range

If any faults or defects (hereinafter "Failure") found to be the responsibility of Mitsubishi occurs during use of the product within the gratis warranty term, the product shall be repaired at no cost via the sales representative or Mitsubishi Service Company. However, if repairs are required onsite at domestic or overseas location, expenses to send an engineer will be solely at the customer's discretion. Mitsubishi shall not be held responsible for any re-commissioning, maintenance, or testing on-site that involves replacement of the failed module.

[Gratis Warranty Term]

The gratis warranty term of the product shall be for one year after the date of purchase or delivery to a designated place. Note that after manufacture and shipment from Mitsubishi, the maximum distribution period shall be six (6) months, and the longest gratis warranty term after manufacturing shall be eighteen (18) months. The gratis warranty term of repair parts shall not exceed the gratis warranty term before repairs.

[Gratis Warranty Range]

- (1) The range shall be limited to normal use within the usage state, usage methods and usage environment, etc., which follow the conditions and precautions, etc., given in the instruction manual, user's manual and caution labels on the product.
- (2) Even within the gratis warranty term, repairs shall be charged for in the following cases.
 1. Failure occurring from inappropriate storage or handling, carelessness or negligence by the user. Failure caused by the user's hardware or software design.
 2. Failure caused by unapproved modifications, etc., to the product by the user.
 3. When the Mitsubishi product is assembled into a user's device, Failure that could have been avoided if functions or structures, judged as necessary in the legal safety measures the user's device is subject to or as necessary by industry standards, had been provided.
 4. Failure that could have been avoided if consumable parts (battery, backlight, fuse, etc.) designated in the instruction manual had been correctly serviced or replaced.
 5. Relay failure or output contact failure caused by usage beyond the specified life of contact (cycles).
 6. Failure caused by external irresistible forces such as fires or abnormal voltages, and failure caused by force majeure such as earthquakes, lightning, wind and water damage.
 7. Failure caused by reasons unpredictable by scientific technology standards at time of shipment from Mitsubishi.
 8. Any other failure found not to be the responsibility of Mitsubishi or that admitted not to be so by the user.

2. Onerous repair term after discontinuation of production

- (1) Mitsubishi shall accept onerous product repairs for seven (7) years after production of the product is discontinued.
Discontinuation of production shall be notified with Mitsubishi Technical Bulletins, etc.
- (2) Product supply (including repair parts) is not available after production is discontinued.

3. Overseas service

Overseas, repairs shall be accepted by Mitsubishi's local overseas FA Center. Note that the repair conditions at each FA Center may differ.

4. Exclusion of loss in opportunity and secondary loss from warranty liability

Regardless of the gratis warranty term, Mitsubishi shall not be liable for compensation to:

- (1) Damages caused by any cause found not to be the responsibility of Mitsubishi.
- (2) Loss in opportunity, lost profits incurred to the user by Failures of Mitsubishi products.
- (3) Special damages and secondary damages whether foreseeable or not, compensation for accidents, and compensation for damages to products other than Mitsubishi products.
- (4) Replacement by the user, maintenance of on-site equipment, start-up test run and other tasks.

5. Changes in product specifications

The specifications given in the catalogs, manuals or technical documents are subject to change without prior notice.

6. Product application

- (1) In using the Mitsubishi MELSEC PLC, the usage conditions shall be that the application will not lead to a major accident even if any problem or fault should occur in the PLC device, and that backup and fail-safe functions are systematically provided outside of the device for any problem or fault.
- (2) The Mitsubishi PLC has been designed and manufactured for applications in general industries, etc. Thus, applications in which the public could be affected such as in nuclear power plants and other power plants operated by respective power companies, and applications in which a special quality assurance system is required, such as for railway companies or public service purposes shall be excluded from the PLC applications.
In addition, applications in which human life or property that could be greatly affected, such as in aircraft, medical applications, incineration and fuel devices, manned transportation, equipment for recreation and amusement, and safety devices, shall also be excluded from the PLC range of applications.
However, in certain cases, some applications may be possible, providing the user consults their local Mitsubishi representative outlining the special requirements of the project, and providing that all parties concerned agree to the special circumstances, solely at the user's discretion.

TRADEMARKS

Ethernet is a registered trademark of Fuji Xerox Co., Ltd. in Japan.

PROFIBUS is a trademark of PROFIBUS Nutzerorganisation e.V.

Anywire and AnyWireASLINK are either registered trademarks or trademarks of Anywire Corporation.

The company names, system names and product names mentioned in this manual are either registered trademarks or trademarks of their respective companies.

In some cases, trademark symbols such as [™] or [®] are not specified in this manual.

Manual number: SH(NA)-081805ENG-D

Model: FX5-U-POS-I-E

Model code: 09R572

When exported from Japan, this manual does not require application to the Ministry of Economy, Trade and Industry for service transaction permission.

MITSUBISHI ELECTRIC CORPORATION

HEAD OFFICE: TOKYO BUILDING, 2-7-3 MARUNOUCHI, CHIYODA-KU, TOKYO 100-8310, JAPAN

Specifications are subject to change without notice.